

Presentation

Part Number: WM 250.120CTNK

Dual 615 mm Horizontal Medical Arm for monitoring Adaptation to 5" plate and Nihon Kohden Interface, table column mounting. Compatible with Nihon Kohden monitoring

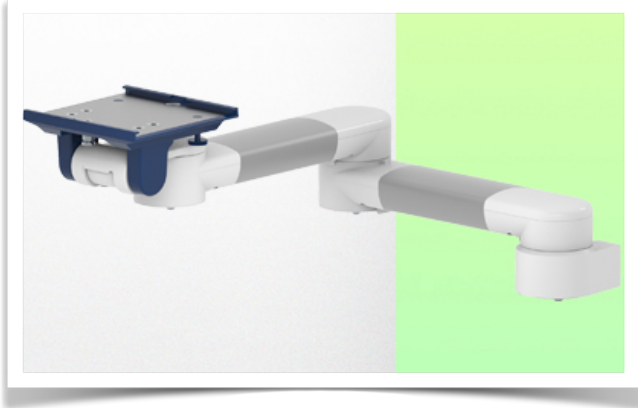

Cette colonne possède deux rails de fixation pour les différents éléments qui y seront fixés. (1 rail à l'avant de la colonne, 1 rail à l'arrière)

This column has two fixing rails for the different elements that will be fixed to it (1 rail at the front of the column, 1 rail at the back)

Deze zuil heeft twee bevestigingsrails voor de verschillende elementen die eraan bevestigd zullen worden (1 rail aan de voorkant van de zuil, 1 rail aan de achterkant)

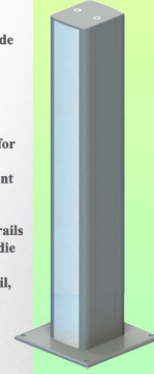

Dual 615 mm Horizontal Medical Arm for monitoring Adaptation to 5" plate and Nihon Kohden Interface, table column mounting. Compatible with Nihon Kohden monitoring

This dual 615 mm Horizontal Arm allows the monitor to be fixed, oriented and adjusted perfectly. It is coated with an anti-microbial agent for hygiene and cleaning down to the smallest detail. Its modern design has been specially developed for healthcare environments.

Technical specifications:

- * Integral cable management
- * Lightweight application
- * Optional table-top column mounting, available in a range of heights (500 - 300 mm). These columns can be easily cut to size. All cables are also routed through the column (see Option on following pages)
- * This 615 mm Horizontal Arm simply slides into the column rail, then adjusts to the required height and locks in place. It has no height adjustment
- * The head of this arm complies with the mounting standard for Nihon Kohden monitors weighing up to 8 Kg.
- * Monitor tilt: 20° down and 12° up
- * Monitor rotation: 115° right, 115° left.
- * Arm rotation: 105° right, 105° left.
- * Total length 615 mm
- * Colour RAL 5013 cobalt blue and RAL 9016 traffic white
- * Warranty: 5 years

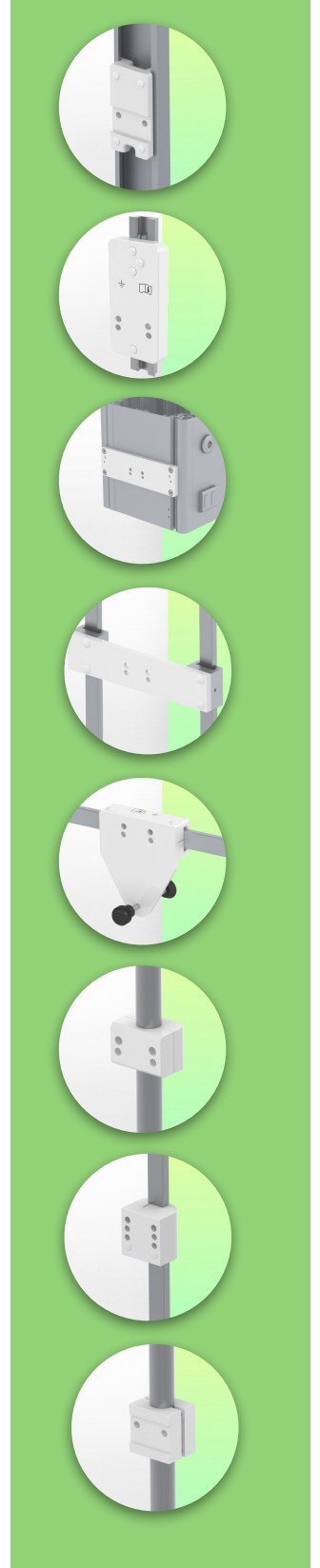

Technical specifications

Part Number: WM 250.120CTNK

Dual 615 mm Horizontal Medical Arm for monitoring Adaptation to 5" plate and Nihon Kohden Interface, table column mounting. Compatible with Nihon Kohden monitoring

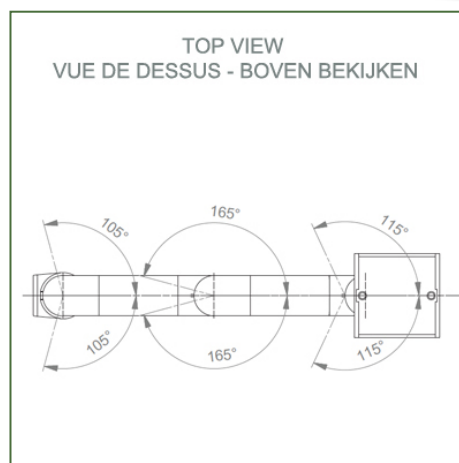
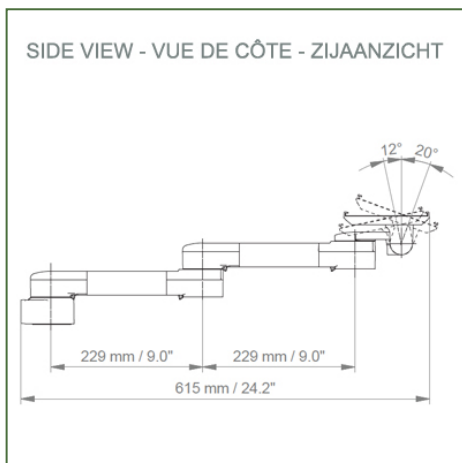
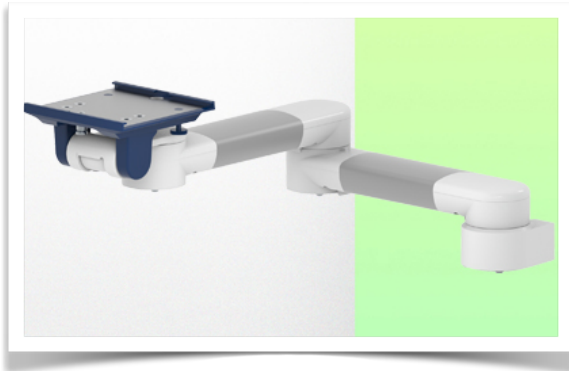

Monitor fitting: 5" Plunge plate
 Color: Decorative parts: RAL 5013 cobalt blue
 Aluminium parts: RAL 9016 traffic white
 Max. load capacity of support arm: 8 kg
 Monitor fitting max. load: 8 Kg
 Product weight: 2,8 Kg

Product strengths:

Non-height-adjustable arm. Swivel arms and extended swivel arms offer full cable integration and easy cleaning for infection control in all critical care areas of the clinical environment. Our 5-year guarantee ensures reliable, trouble-free and maintenance-free operation. The swivel function at the point of attachment and the tilt and swivel function of the monitor adaptation provide optimum positioning of your unit. The extended swivel arm is a two-part arm with a central pivot point between the two arm sections. All bottom-mounted monitors have the safety feature of a 20° tilt stop.

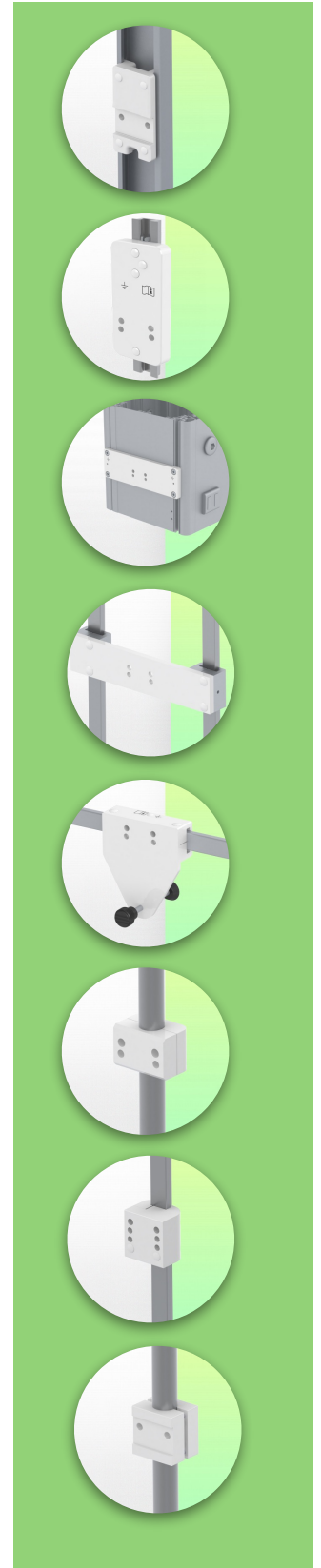

Installation information - Column slide rail

Part Number: WM 250.120CTNK

Dual 615 mm Horizontal Medical Arm for monitoring Adaptation to 5" plate and Nihon Kohden Interface, table column mounting. Compatible with Nihon Kohden monitoring

Table column:

To install this medical arm, you need to use one of our medical columns. These are available in standard heights of 500 mm and 300 mm. Custom heights are available on request. Slide covers and end caps are supplied with every order.

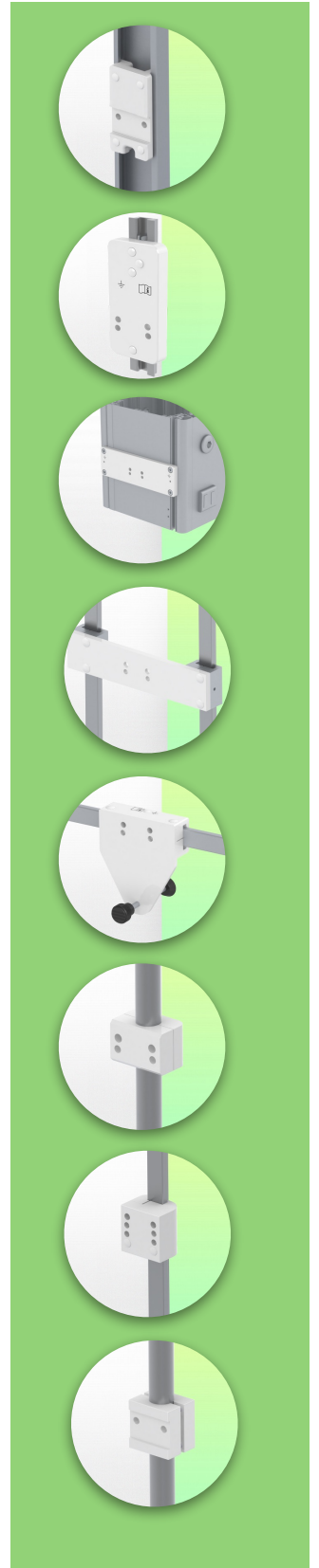
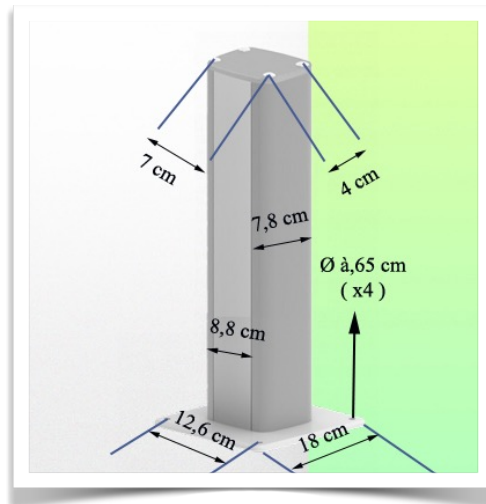
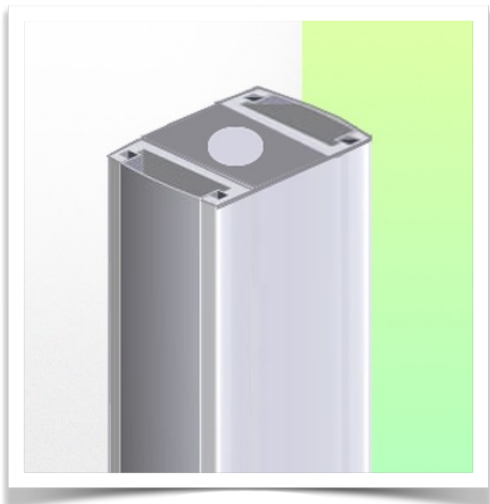
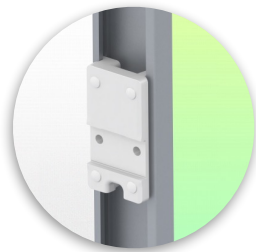
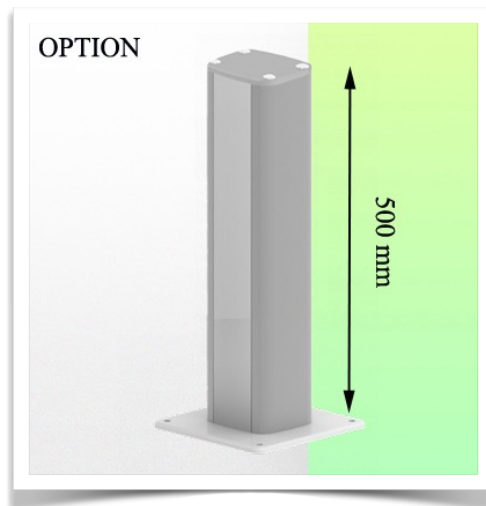
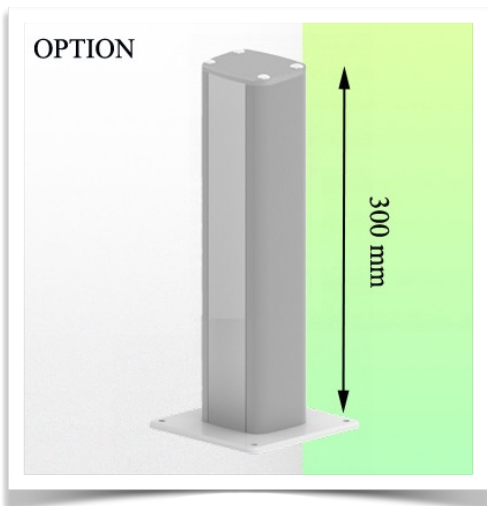

Presentation

Part Number: WM 250.120CTNK

Dual 615 mm Horizontal Medical Arm for monitoring Adaptation to 5" plate and Nihon Kohden Interface, table column mounting. Compatible with Nihon Kohden monitoring

**Adaptateur pour Nihon Kohden
Adapter for Nihon Kohden
Adapter voor Nihon Kohden**

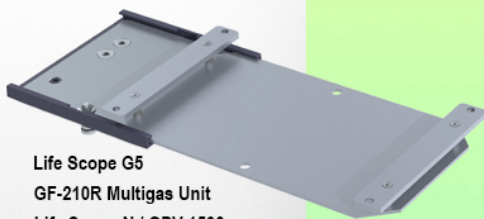

Life Scope G5
GF-210R Multigas Unit
Life Scope N / OPV 1500
Life Scope i / Life Scope L / BSM 2301 / BSM 2303
Vismo PVM 2700 Vismo PVM 4000
Life Scope VS / BSM 3500 / BSM 3700, Vismo PVM 2700
Life Scope A / BSM 5105 / BSM 5135
Life Scope TR / BSM 6301K / BSM 6501K / BSM 6701K



Adaptation with 5" plunger plate

Monitor mounting plates for monitoring

The 5" plunger plate is designed to accommodate bottom-mounted monitors. Please note that a special mounting adapter is required for some monitors. The mounting adapter is installed on the bottom and slides into the 5" immersion plate. For Dräger and GE monitors, a special mounting adapter is not required. For Mindray, Nihon Kohden, Spacelabs and Philips Sure Signs/ Vital Signs monitors, mounting adapters are required. For the Philips IntelliVue series, please refer to the Philips Monitoring IntelliVue Series.

All our medical arms can be equipped with this adaptation, of which you will find some illustrations here.

All height-adjustable arms have a weight capacity of 22 kg. Rear-mounted monitor adapters and horizontally mounted 5" plinths accept a maximum monitor weight of 18 kg. An additional 4 kg can be mounted on a downstand under the front rotating part. Depending on the material and the strength factor, all weight indications have a safety factor of 4 and/or 6 times according to NF 60601-1 regulations. The current IEC 60601-1 standard for medical electrical equipment is the 3rd edition

For customised solutions and MRI applications please contact us

Presentation

Part Number: WM 250.120CTNK

Dual 615 mm Horizontal Medical Arm for monitoring Adaptation to 5" plate and Nihon Kohden Interface, table column mounting. Compatible with Nihon Kohden monitoring

