

## Presentation

Part Number: WM 335.112

### Horizontal swivel medical arm 2 x 300 mm for keyboard and mouse, floor or ceiling column mount

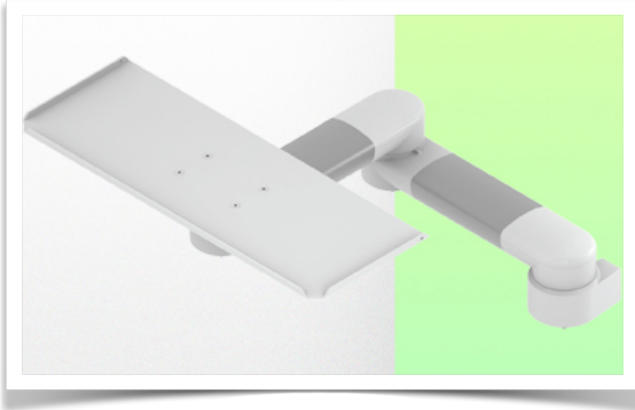

Cette colonne possède deux rails de fixation pour les différents éléments qui y seront fixés. (1 rail à l'avant de la colonne, 1 rail à l'arrière)

This column has two fixing rails for the different elements that will be fixed to it (1 rail at the front of the column, 1 rail at the back)

Deze zuil heeft twee bevestigingsrails voor de verschillende elementen die eraan bevestigd zullen worden (1 rail aan de voorkant van de zuil, 1 rail aan de achterkant)

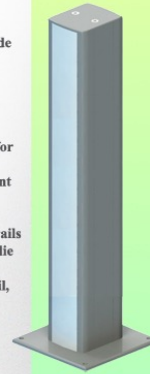

### Horizontal swivel medical arm 2 x 300 mm for keyboard and mouse, floor or ceiling column mount

This 2 x 300 mm swivel medical arm allows you to fix, orientate and adjust your keyboard and mouse perfectly. It is coated with an anti-microbial agent to ensure hygiene and cleanliness down to the smallest detail. Its modern design has been specially developed for healthcare environments.

#### Technical features:

- \* Integrated cable management
- \* Floor or ceiling column mount
- \* The 2 x 300mm swivel arm simply clips onto the column.
- \* The keyboard and mouse support supplied in this version has the following dimensions  
dimensions: 500 x 200 mm (other keyboard support configurations are also available, see following pages)
- \* The weight supported by the arm is 6 kg.
- \* Keyboard support rotation: +78° -258°.
- \* Arm rotation: 105° to the right, 105° to the left.
- \* Total length 608 mm \* Colour RAL 7024 (Graphite grey) and White
- \* All our medical arms are CE, ROHS, Medical Grade, MDD 93/42 ECC compliant.
- \* Warranty: 5 years
- \* 240 mm version also available



**Technical Specifications**

**Part Number: WM 335.112**

**Horizontal swivel medical arm 2 x 300 mm for keyboard and mouse, floor or ceiling column mount**

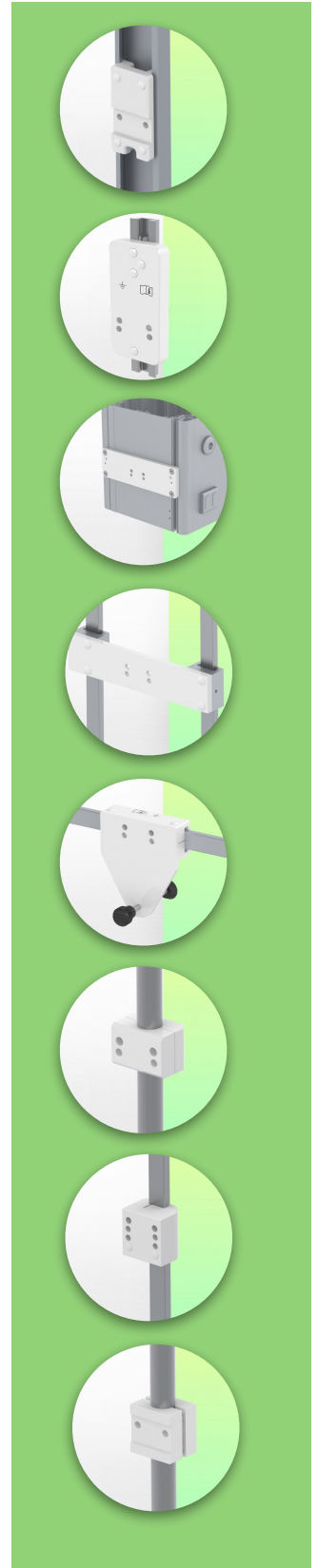
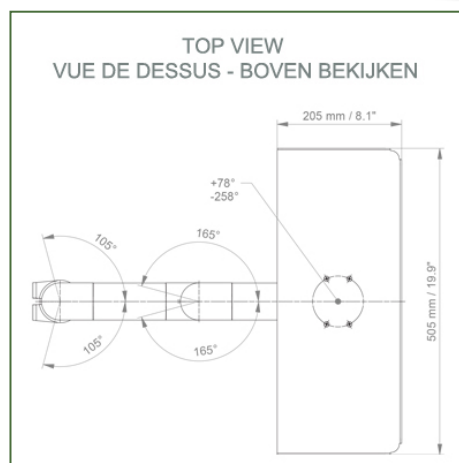
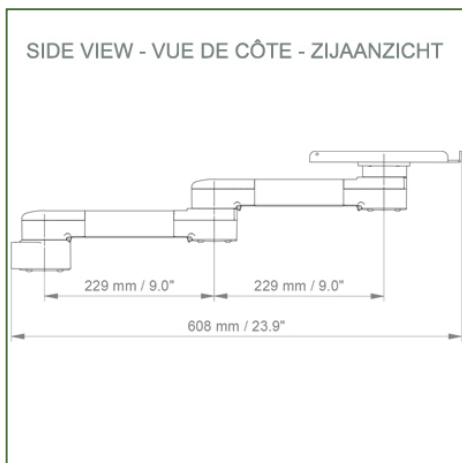
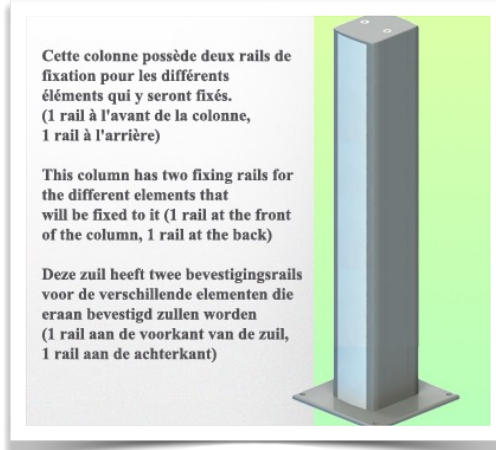
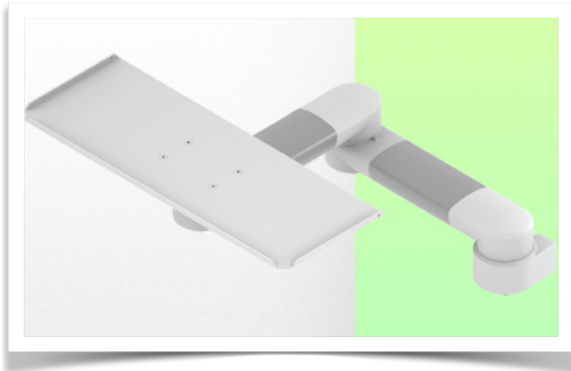

**Keyboard stand dimensions: 500 x 200 mm**

**Colour: Decorative parts: RAL 5013 cobalt blue**

**Aluminium parts: RAL 9016 traffic white**

**Max. load capacity of support arm: 6 kg**

**Tray load capacity: 5 Kg**

**Product weight: between 1.9 and 3.4 Kg depending on the choice of keyboard and mouse tray**

**Mounting Information - Wall Slide Rail**

**Part Number: WM 335.112**

**Horizontal swivel medical arm 2 x 300 mm for keyboard and mouse, floor or ceiling column mount**

**Floor or ceiling column:**

To install this medical arm, you need to use one of our medical columns. These are available in standard heights of 1500 and 2000 mm. Custom heights are available on request. Slide covers and end caps are supplied with every order.

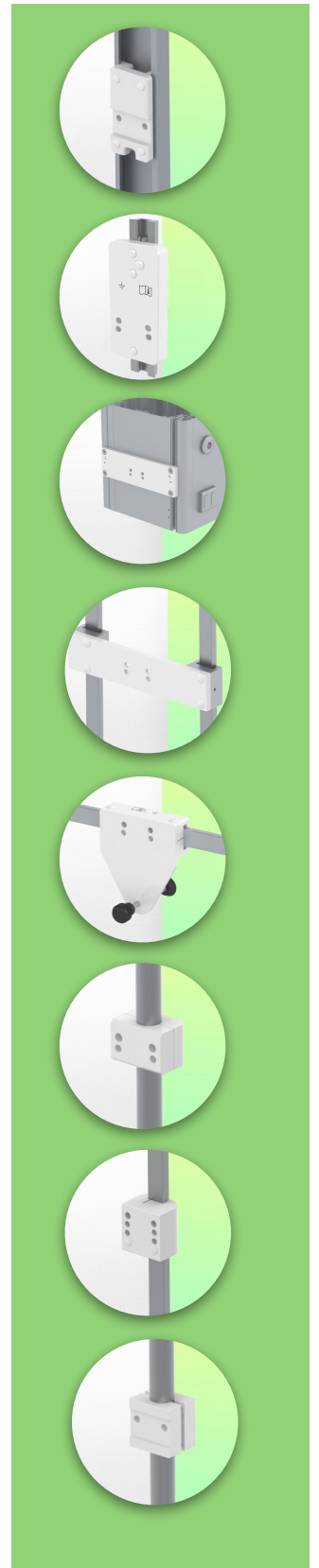
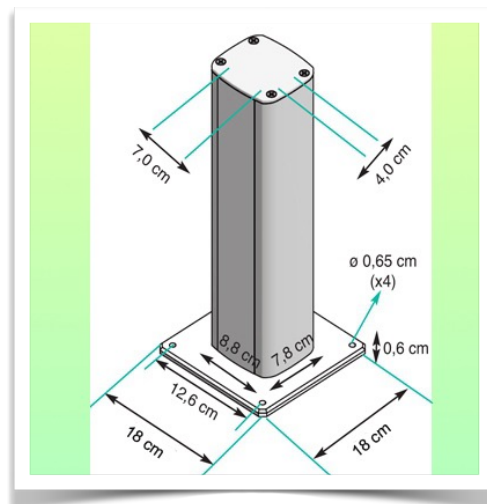
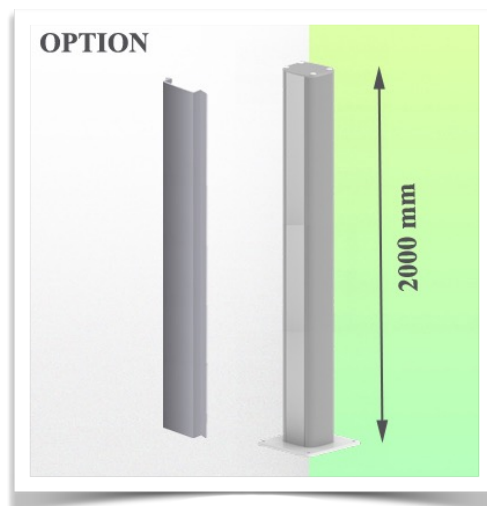
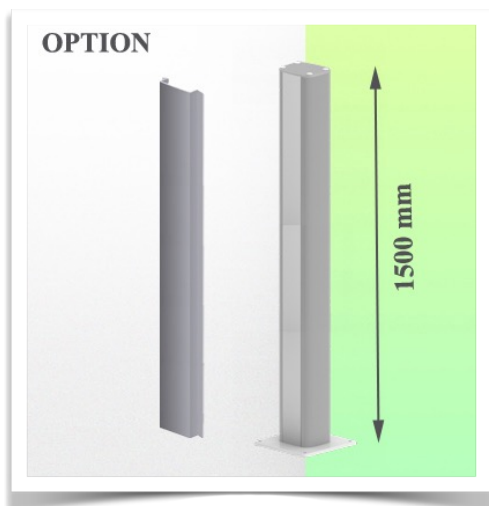

**Mounting information - Mounting options**

**Part Number: WM 335.112**

**Horizontal swivel medical arm 2 x 300 mm for keyboard and mouse,  
floor or ceiling column mount**

**Where do you want to mount the support arm?**

At the hospital, there are different ways to fix our brackets: round tube, standard rail, wall rail or on an anaesthesia machine. We will always provide you with the adapter you need.

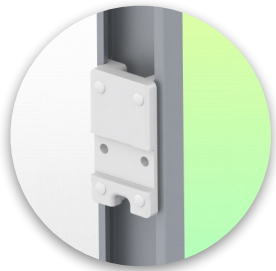

**Adapter for vertical wall slide**  
For wall slide mounting



**Adapter for Amico remote controls and wall panels**



**Adapter for Mindray medical power supply units**



**Double clamp for vertical standard rail**  
For mounting on two parallel vertical standard rails 10 x 25 mm



**Fixed clamp for a standard rail**  
For mounting on a horizontal standard rail 10 x 25, 8 x 35, 10 x 30, 10 x 50 mm



**Fixed clamp for round tube**  
For mounting on round tube  $\varnothing$  25, 35, 38 mm

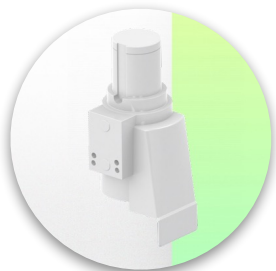

**Adapter for Maquet anaesthesia machines**  
Cone Adapter for Model FLOW i



**Adapter for Löwenstein anaesthesia machines**  
Medical Adapter for Leon / Leon plus

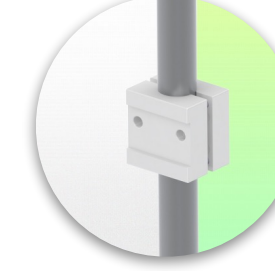

**Universal round tube clamp**  
V-clamp for mounting on round tube  $\varnothing$  23 - 40 mm

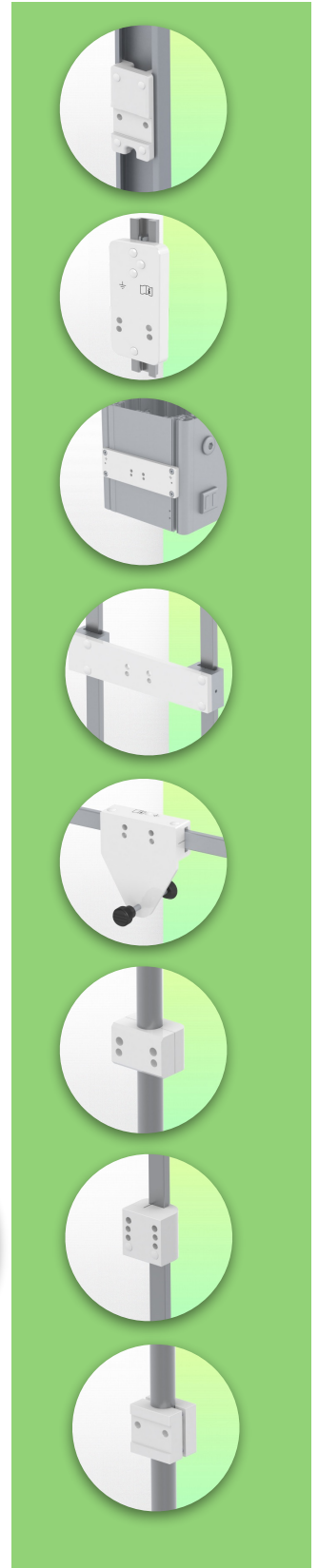

**Mounting information - Mounting options**

**Part Number: WM 335.112**

**Horizontal swivel medical arm 2 x 300 mm for keyboard and mouse, floor or ceiling column mount**

**Where do you want to mount the support arm?**

At the hospital, there are different ways to fix our brackets: round tube, standard rail, wall rail or on an anaesthesia machine. We will always provide you with the adapter you need.

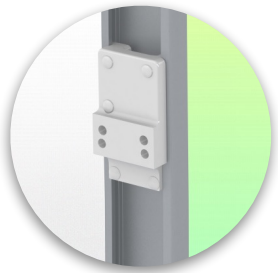

**Adapter for anaesthesia machine (all suppliers)**

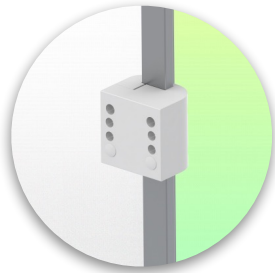

**Clamp for a vertical standard rail**



**Floor or ceiling column 1500 mm or 2000 mm**

For



Considered to be the world's best in advanced hygiene control, our medical mounting systems include cable integration, a 5-year maintenance-free warranty and medical grade compliance. We're simply the best in the world at what we do.

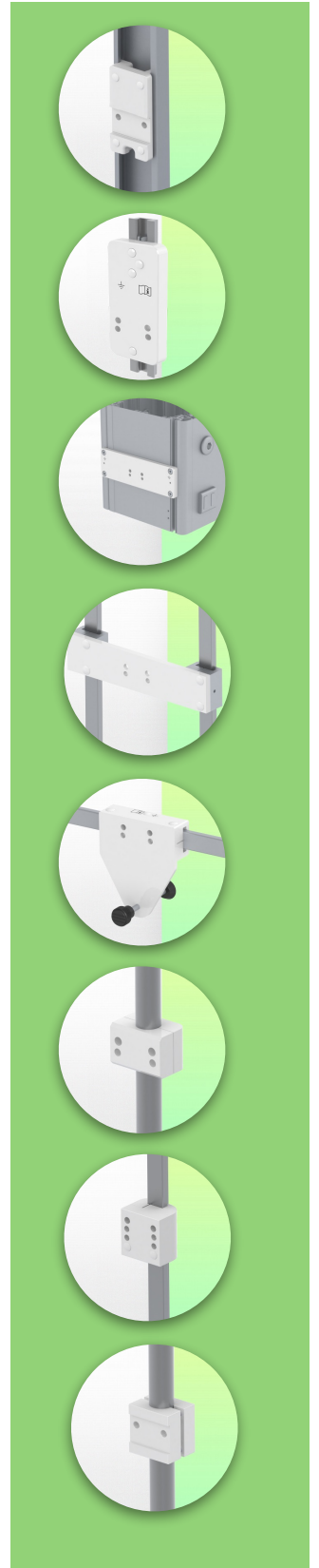

**Compatible accessories for this mount**

**Part Number: WM 335.112**

**Horizontal swivel medical arm 2 x 300 mm for keyboard and mouse, floor or ceiling column mount**

**Compatible accessories for this 300 mm Horizontal Arm**

You can complete your installation with these additional accessories:



**Triple hook for cable** For mounting on support arm



**Double hook for cable** For mounting on support arm



**Downward pole with cable hook** For mounting on support arm



**Double handle with VESA mounting** For VESA monitors



**Handle for VESA monitor support** For VESA monitors

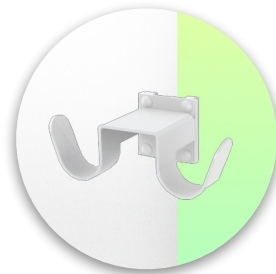

**Double hook for cable** For mounting on a wall or column rail



**Triple hook for cable** For wall or column rail mounting



**Basket** For wall or column rail mounting



**Downward Pole** For mounting on support arm

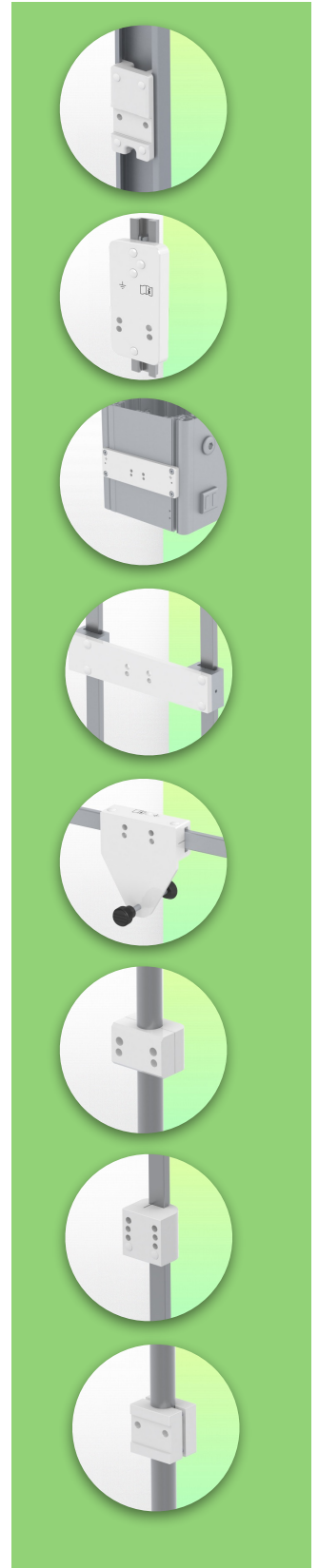

**Keyboard and mouse support options**

**Part Number: WM 335.112**

**Horizontal swivel medical arm 2 x 300 mm for keyboard and mouse, floor or ceiling column mount**

**Compatible accessories for this 300 mm Horizontal arm**

You can complete your installation with these optional accessories:

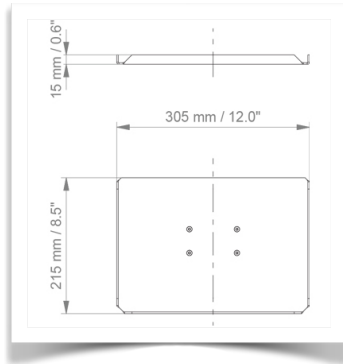

**Keyboard and mouse holder 305 x 215 mm**

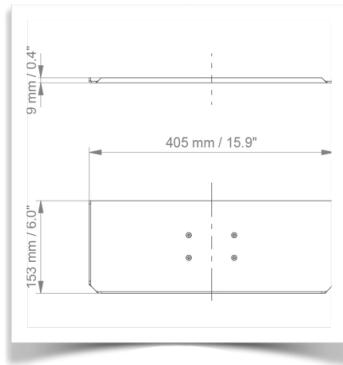

**Keyboard and mouse holder 405 x 153 mm**

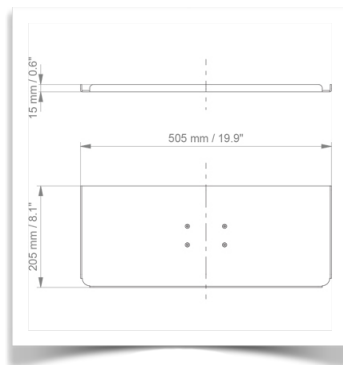

**Keyboard and mouse holder 505 x 205 mm (Standard)**

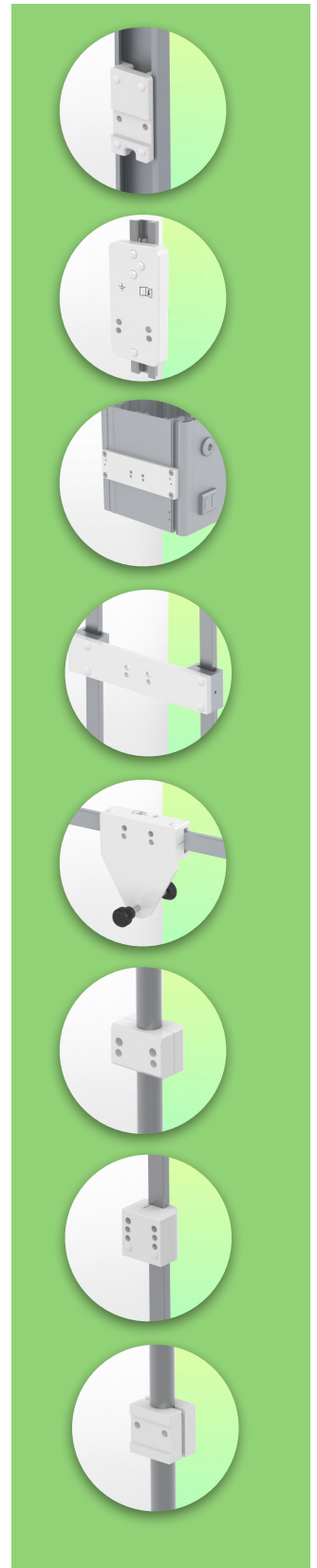

**Keyboard and mouse support options**

**Part Number: WM 335.112**

**Horizontal swivel medical arm 2 x 300 mm for keyboard and mouse, floor or ceiling column mount**

**Compatible accessories for this 300 mm Horizontal arm**

You can complete your installation with these optional accessories:

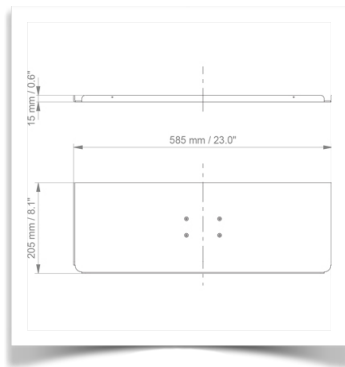

**Keyboard and mouse holder 585 x 205 mm**

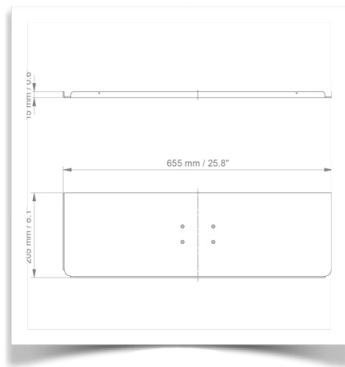

**Keyboard and mouse holder 655 x 205 mm**

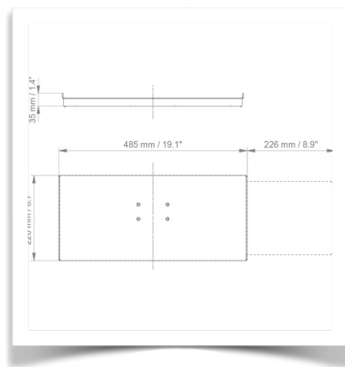

**Sliding keyboard and mouse holder 485 x 220 mm**

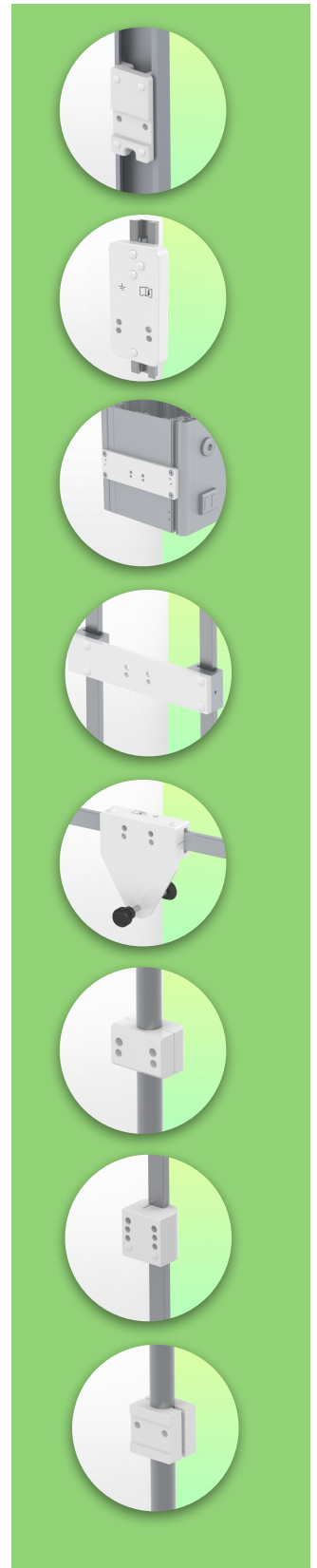



**Keyboard and mouse support options**

**Part Number: WM 335.112**

**Horizontal swivel medical arm 2 x 300 mm for keyboard and mouse, floor or ceiling column mount**

**Compatible accessories for this 300 mm Horizontal arm**

You can complete your installation with these optional accessories:

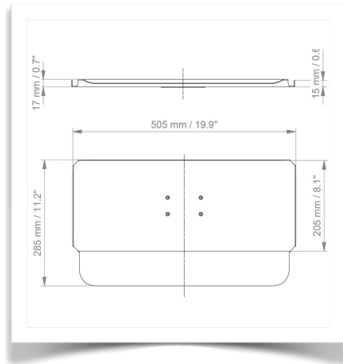

**505 x 205 mm keyboard and mouse stand with wrist rest**

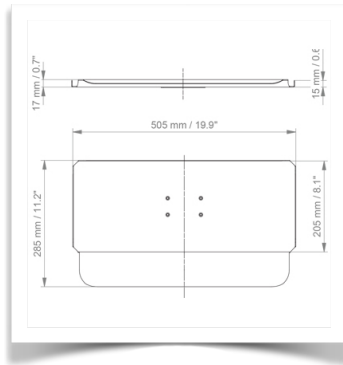

**Keyboard and mouse stand 585 x 205 mm with wrist rest**

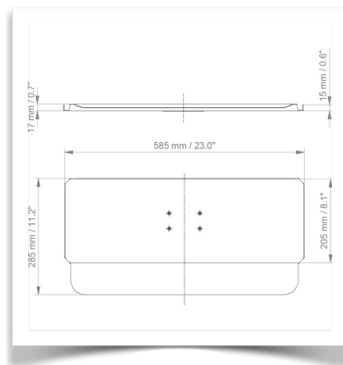

**Keyboard and mouse stand 655 x 205 mm with wrist rest**

