

Presentation

Part Number: WM 335.121

Horizontal swivel medical arm 300 mm for keyboard and mouse, Mounting on Mindray Medical Supply Device

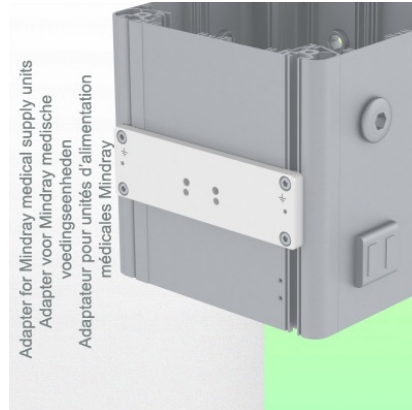
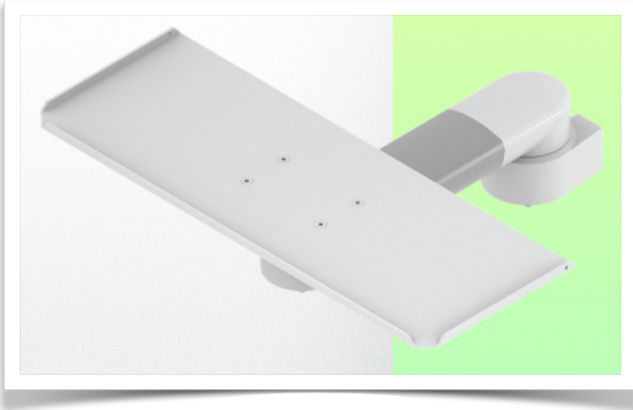

Horizontal swivel medical arm 300 mm for keyboard and mouse, Mounting on Mindray Medical Supply Device

This 300 mm swivel medical arm allows you to fix, orientate and adjust your keyboard and mouse perfectly. It is coated with an anti-microbial agent to ensure hygiene and cleanliness down to the smallest detail. Its modern design has been specially developed for healthcare environments.

Technical features:

- * Integrated cable management
- * Mounting on Mindray Medical Supply Device
- * The 300mm swivel arm simply clips onto the device
- * The keyboard and mouse support supplied in this version has the following dimensions
dimensions: 500 x 200 mm (other keyboard support configurations are also available, see following pages)
- * The weight supported by the arm is 16 kg.
- * Keyboard support rotation: +78° -258°.
- * Arm rotation: 105° to the right, 105° to the left.
- * Total length 379 mm * Colour RAL 7024 (Graphite grey) and White
- * All our medical arms are CE, ROHS, Medical Grade, MDD 93/42 ECC compliant.
- * Warranty: 5 years
- * 240 mm version also available

Technical Specifications

Part Number: WM 335.121

Horizontal swivel medical arm 300 mm for keyboard and mouse, Mounting on Mindray Medical Supply Device

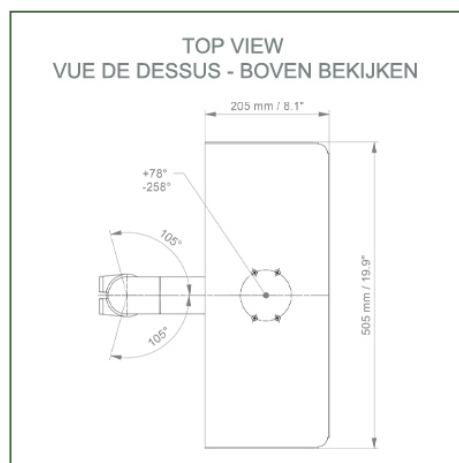
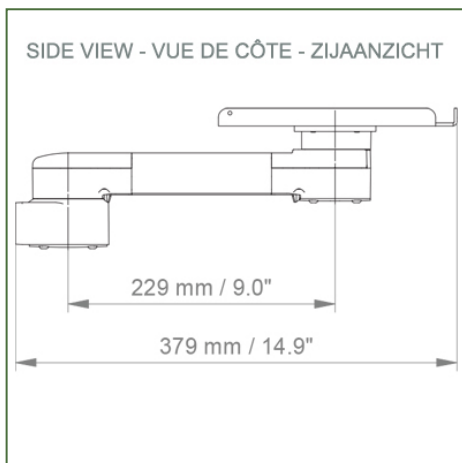
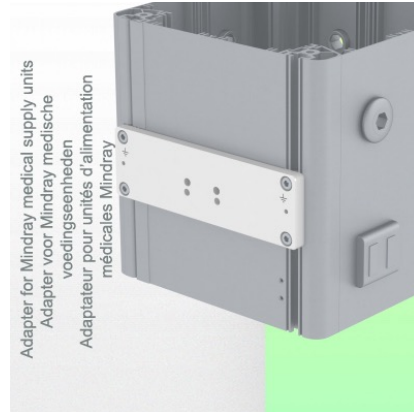
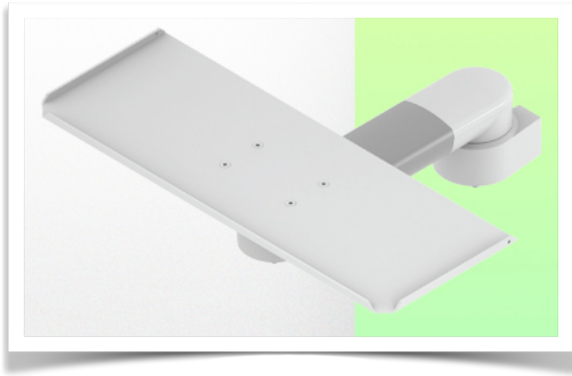

Keyboard stand dimensions: 500 x 200 mm

Colour: Decorative parts: RAL 5013 cobalt blue

Aluminium parts: RAL 9016 traffic white

Max. load capacity of support arm: 16 kg

Tray load capacity: 5 Kg

Product weight: between 1.9 and 3.4 Kg depending on the choice of keyboard and mouse tray

Mounting Information - Adapter Mindray

Part Number: WM 335.121

Horizontal swivel medical arm 300 mm for keyboard and mouse, Mounting on Mindray Medical Supply Device

Adapter Mindray:

Mounting on Mindray Medical Supply Device

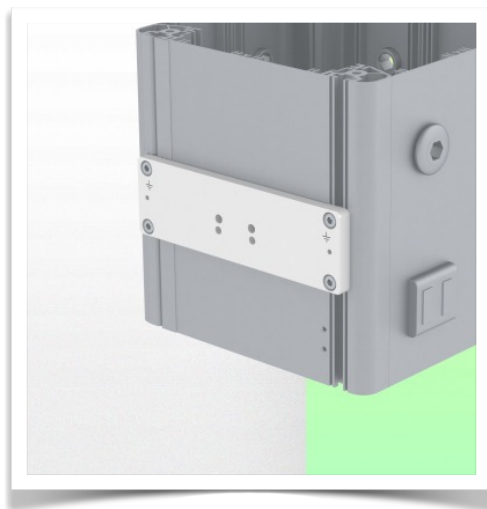
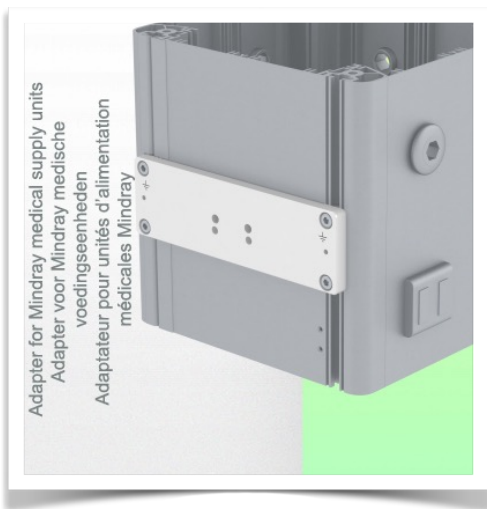

Mounting information - Mounting options

Part Number: WM 335.121

Horizontal swivel medical arm 300 mm for keyboard and mouse, Mounting on Mindray Medical Supply Device

Where do you want to mount the support arm?

At the hospital, there are different ways to fix our brackets: round tube, standard rail, wall rail or on an anaesthesia machine. We will always provide you with the adapter you need.



Adapter for vertical wall slide
For wall slide mounting



Adapter for Amico remote controls and wall panels



Adapter for Mindray medical power supply units



Double clamp for vertical standard rail
For mounting on two parallel vertical standard rails 10 x 25 mm



Fixed clamp for a standard rail
For mounting on a horizontal standard rail 10 x 25, 8 x 35, 10 x 30, 10 x 50 mm



Fixed clamp for round tube
For mounting on round tube \varnothing 25, 35, 38 mm



Adapter for Maquet anaesthesia machines
Cone Adapter for Model FLOW i



Adapter for Löwenstein anaesthesia machines
Medical Adapter for Leon / Leon plus

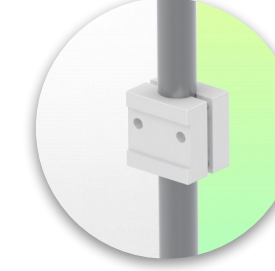

Universal round tube clamp
V-clamp for mounting on round tube \varnothing 23 - 40 mm



Mounting information - Mounting options

Part Number: WM 335.121

Horizontal swivel medical arm 300 mm for keyboard and mouse, Mounting on Mindray Medical Supply Device

Where do you want to mount the support arm?

At the hospital, there are different ways to fix our brackets: round tube, standard rail, wall rail or on an anaesthesia machine. We will always provide you with the adapter you need.

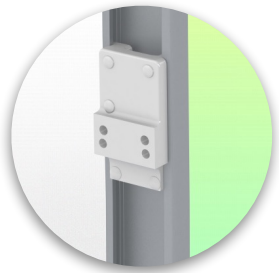

Adapter for anaesthesia machine (all suppliers)

H 80 mm, with existing side rail

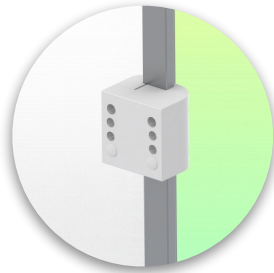

Clamp for a vertical standard rail

For mounting on standard rail 10 x 25 mm



Considered to be the world's best in advanced hygiene control, our medical mounting systems include cable integration, a 5-year maintenance-free warranty and medical grade compliance. We're simply the best in the world at what we do.



Compatible accessories for this mount

Part Number: WM 335.121

Horizontal swivel medical arm 300 mm for keyboard and mouse, Mounting on Mindray Medical Supply Device

Compatible accessories for this 300 mm Horizontal Arm

You can complete your installation with these additional accessories:



Triple hook for cable
For mounting on support arm



Double hook for cable
For mounting on support arm



Downward pole with cable hook
For mounting on support arm

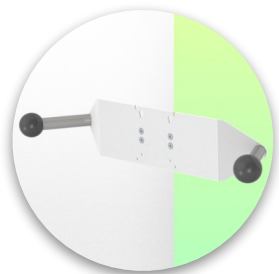

Double handle with VESA mounting
For VESA monitors



Handle for VESA monitor support
For VESA monitors



Double hook for cable
For wall or column rail mounting



Triple hook for cable
For wall or column rail mounting



Basket
For wall or column rail mounting



Downward Pole
For wall or column rail mounting

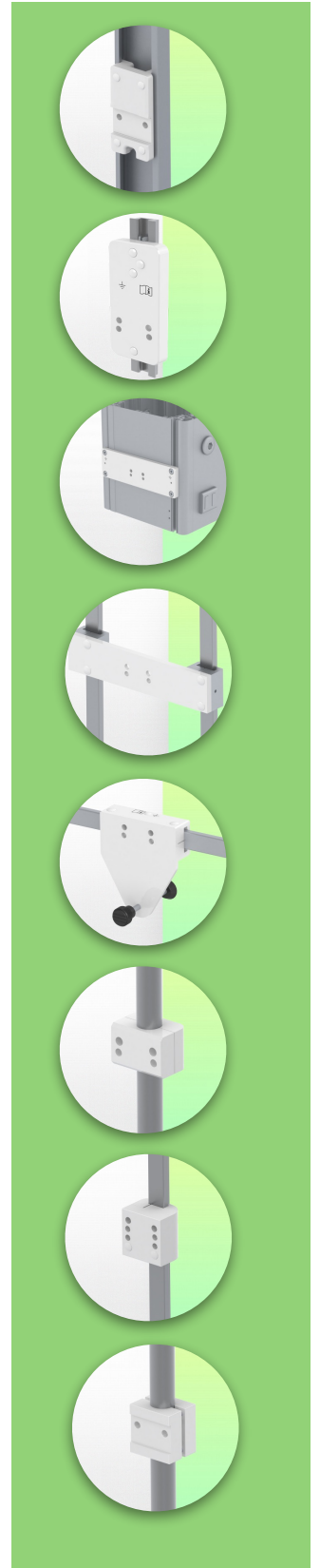

Keyboard and mouse support options

Part Number: WM 335.121

Horizontal swivel medical arm 300 mm for keyboard and mouse, Mounting on Mindray Medical Supply Device

Compatible accessories for this 300 mm Horizontal arm

You can complete your installation with these optional accessories:

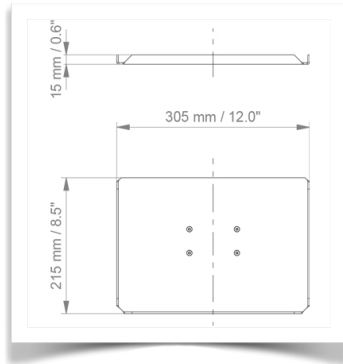

Keyboard and mouse holder 305 x 215 mm

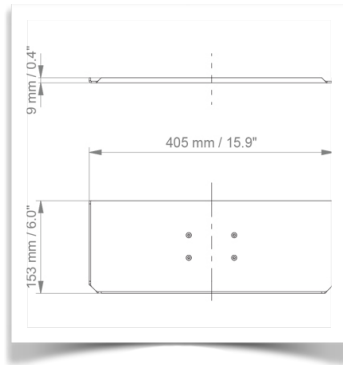

Keyboard and mouse holder 405 x 153 mm

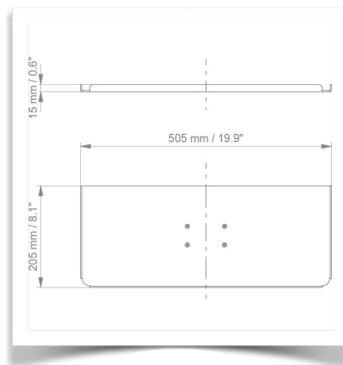

Keyboard and mouse holder 505 x 205 mm (Standard)

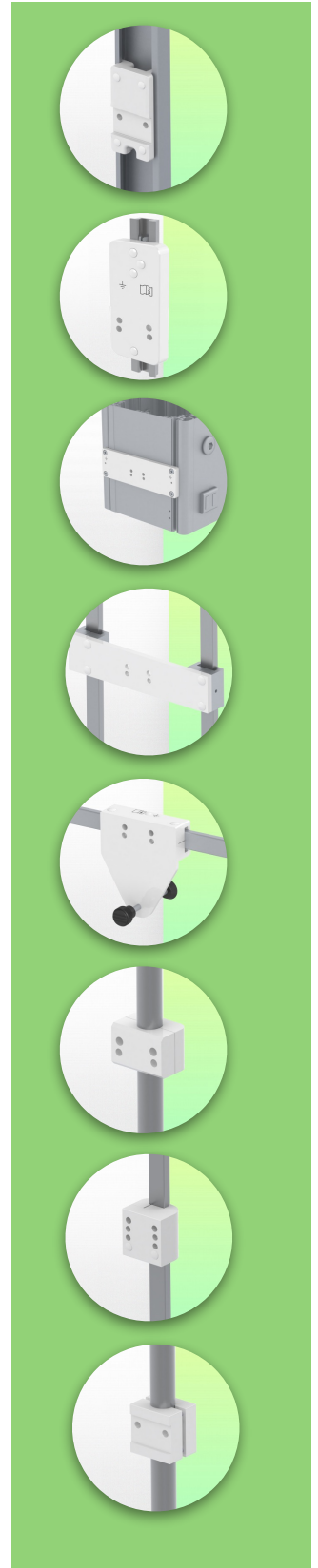

Keyboard and mouse support options

Part Number: WM 335.121

Horizontal swivel medical arm 300 mm for keyboard and mouse, Mounting on Mindray Medical Supply Device

Compatible accessories for this 300 mm Horizontal arm

You can complete your installation with these optional accessories:

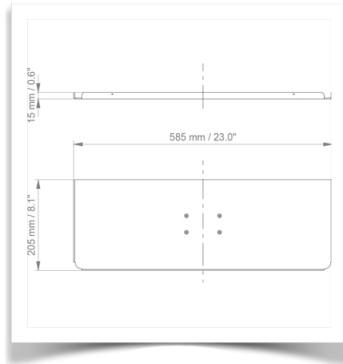

Keyboard and mouse holder 585 x 205 mm

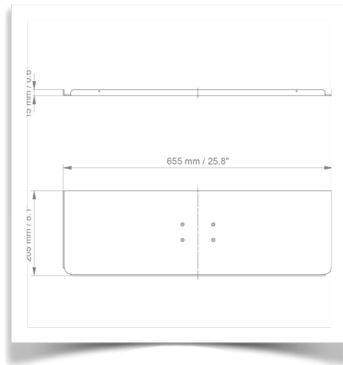

Keyboard and mouse holder 655 x 205 mm

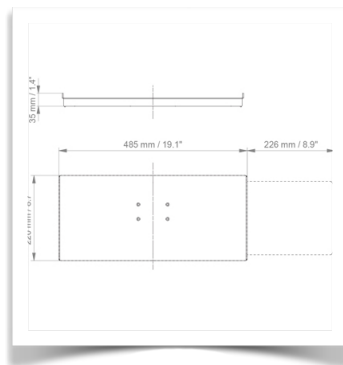

Sliding keyboard and mouse holder 485 x 220 mm

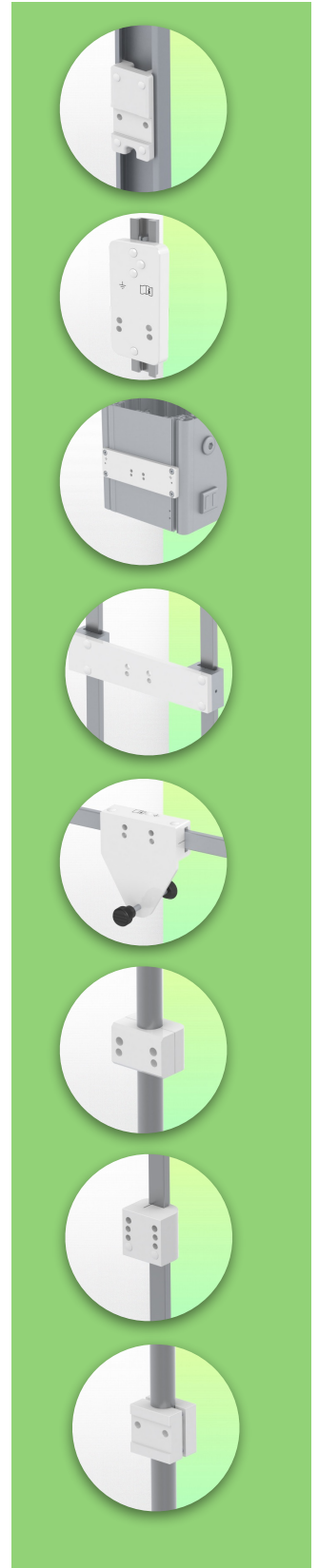

Keyboard and mouse support options

Part Number: WM 335.121

Horizontal swivel medical arm 300 mm for keyboard and mouse, Mounting on Mindray Medical Supply Device

Compatible accessories for this 300 mm Horizontal arm

You can complete your installation with these optional accessories:

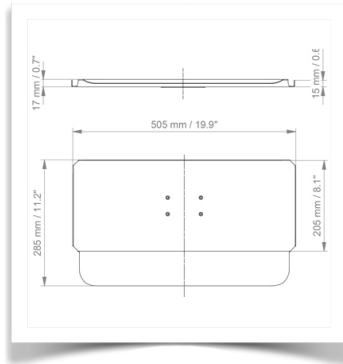

505 x 205 mm keyboard and mouse stand with wrist rest

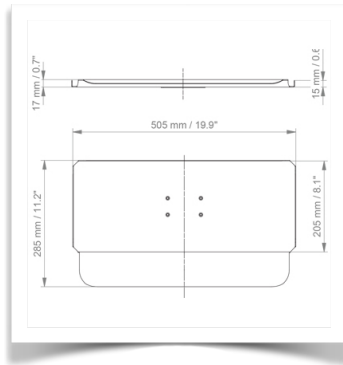

Keyboard and mouse stand 585 x 205 mm with wrist rest

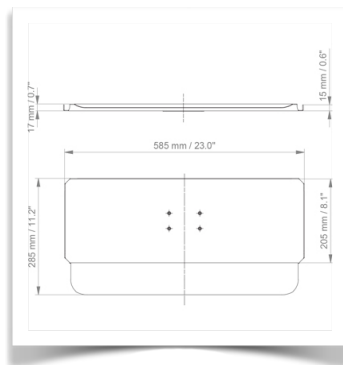

Keyboard and mouse stand 655 x 205 mm with wrist rest

