

**Presentation**

**Part Number: WM 335.122**

**Horizontal swivel medical arm 2 x 300 mm for keyboard and mouse, Mounting on Mindray Medical Supply Device**

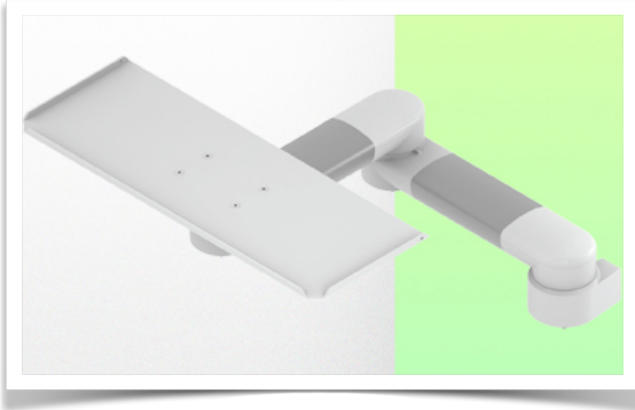

**Horizontal swivel medical arm 2 x 300 mm for keyboard and mouse, Mounting on Mindray Medical Supply Device**

This 2 x 300 mm swivel medical arm allows you to fix, orientate and adjust your keyboard and mouse perfectly. It is coated with an anti-microbial agent to ensure hygiene and cleanliness down to the smallest detail. Its modern design has been specially developed for healthcare environments.

**Technical features:**

- \* Integrated cable management
- \* Mounting on Mindray Medical Supply Device
- \* The 2 x 300mm swivel arm simply clips onto the device
- \* The keyboard and mouse support supplied in this version has the following dimensions  
dimensions: 500 x 200 mm (other keyboard support configurations are also available, see following pages)
- \* The weight supported by the arm is 6 kg.
- \* Keyboard support rotation: +78° -258°.
- \* Arm rotation: 105° to the right, 105° to the left.
- \* Total length 608 mm \* Colour RAL 7024 (Graphite grey) and White
- \* All our medical arms are CE, ROHS, Medical Grade, MDD 93/42 ECC compliant.
- \* Warranty: 5 years

**Technical Specifications**

**Part Number: WM 335.122**

**Horizontal swivel medical arm 2 x 300 mm for keyboard and mouse, Mounting on Mindray Medical Supply Device**

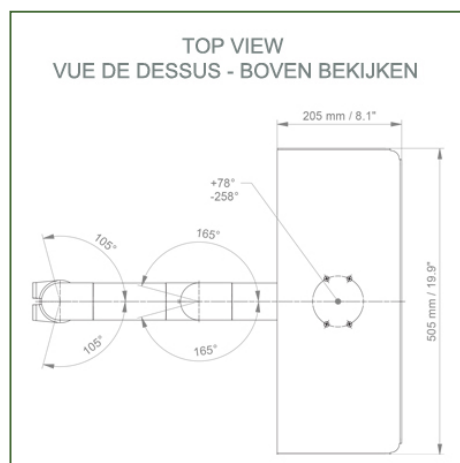
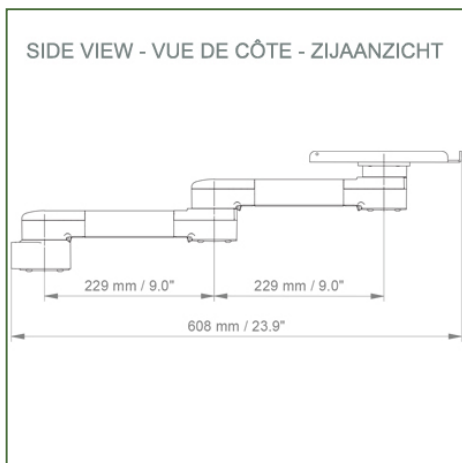
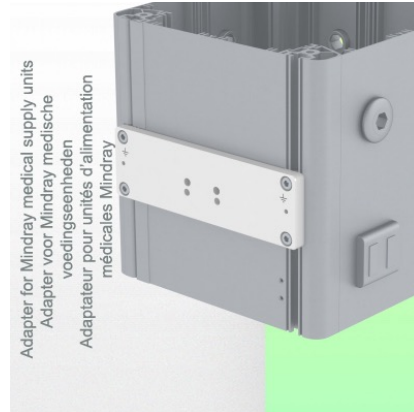
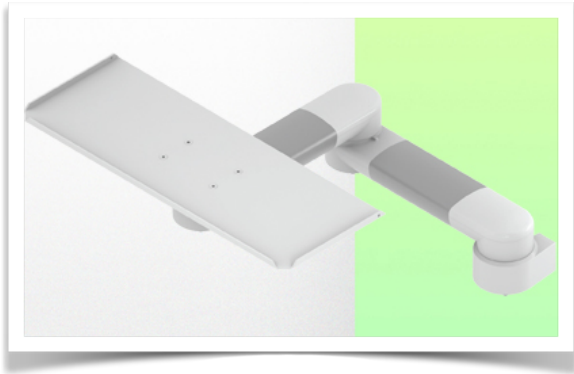

**Keyboard stand dimensions: 500 x 200 mm**

**Colour: Decorative parts: RAL 5013 cobalt blue**

**Aluminium parts: RAL 9016 traffic white**

**Max. load capacity of support arm: 16 kg**

**Tray load capacity: 5 Kg**

**Product weight: between 1.9 and 3.4 Kg depending on the choice of keyboard and mouse tray**

**Mounting Information - Adapter Mindray**

**Part Number: WM 335.122**

**Horizontal swivel medical arm 2 x 300 mm for keyboard and mouse, Mounting on Mindray Medical Supply Device**

**Adapter Mindray:**

Mounting on Mindray Medical Supply Device

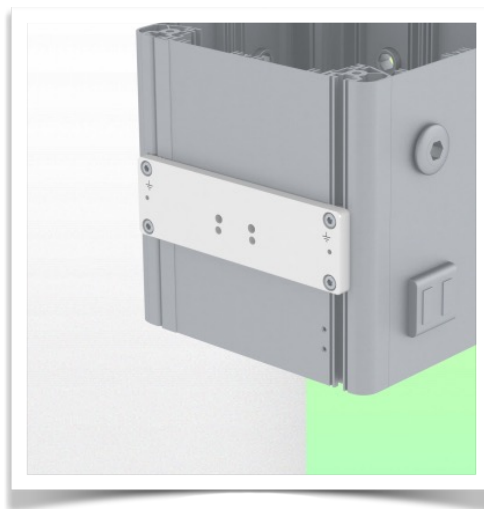
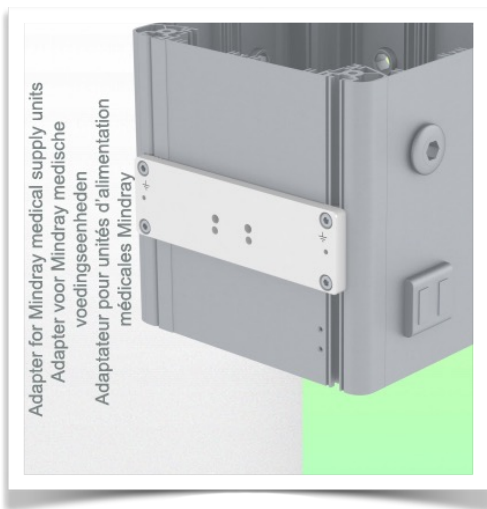

**Mounting information - Mounting options**

**Part Number: WM 335.122**

**Horizontal swivel medical arm 2 x 300 mm for keyboard and mouse, Mounting on Mindray Medical Supply Device**

**Where do you want to mount the support arm?**

At the hospital, there are different ways to fix our brackets: round tube, standard rail, wall rail or on an anaesthesia machine. We will always provide you with the adapter you need.

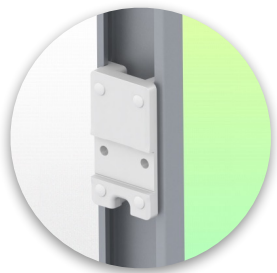

**Adapter for vertical wall slide**  
For wall slide mounting



**Adapter for Amico remote controls and wall panels**

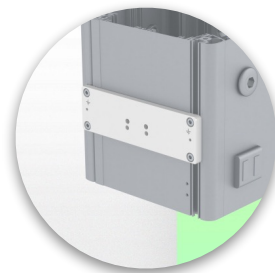

**Adapter for Mindray medical power supply units**

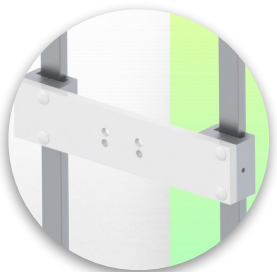

**Double clamp for vertical standard rail**  
For mounting on two parallel vertical standard rails 10 x 25 mm

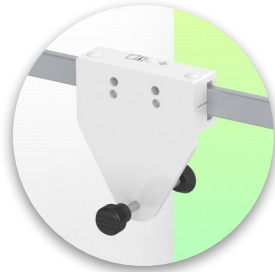

**Fixed clamp for a standard rail**  
For mounting on a horizontal standard rail 10 x 25, 8 x 35, 10 x 30, 10 x 50 mm

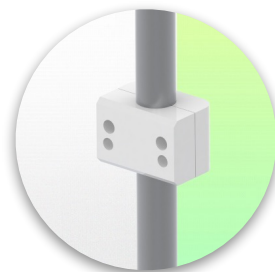

**Fixed clamp for round tube**  
For mounting on round tube  $\varnothing$  25, 35, 38 mm



**Adapter for Maquet anaesthesia machines**  
Cone Adapter for Model FLOW i



**Adapter for Löwenstein anaesthesia machines**  
Medical Adapter for Leon / Leon plus



**Universal round tube clamp**  
V-clamp for mounting on round tube  $\varnothing$  23 - 40 mm



**Mounting information - Mounting options**

**Part Number: WM 335.122**

**Horizontal swivel medical arm 2 x 300 mm for keyboard and mouse, Mounting on Mindray Medical Supply Device**

**Where do you want to mount the support arm?**

At the hospital, there are different ways to fix our brackets: round tube, standard rail, wall rail or on an anaesthesia machine. We will always provide you with the adapter you need.



**Adapter for anaesthesia machine (all suppliers)**

H 80 mm, with existing side rail



**Clamp for a vertical standard rail**

For mounting on standard rail 10 x 25 mm



Considered to be the world's best in advanced hygiene control, our medical mounting systems include cable integration, a 5-year maintenance-free warranty and medical grade compliance. We're simply the best in the world at what we do.



**Compatible accessories for this mount**

**Part Number: WM 335.122**

**Horizontal swivel medical arm 2 x 300 mm for keyboard and mouse, Mounting on Mindray Medical Supply Device**

**Compatible accessories for this 300 mm Horizontal Arm**

You can complete your installation with these additional accessories:



**Triple hook for cable**  
For mounting on support arm



**Double hook for cable**  
For mounting on support arm



**Downward pole with cable hook**  
For mounting on support arm



**Double handle with VESA mounting**  
For VESA monitors



**Handle for VESA monitor support**  
For VESA monitors



**Double hook for cable**  
For wall or column rail mounting



**Triple hook for cable**  
For wall or column rail mounting



**Basket**  
For wall or column rail mounting



**Downward Pole**  
For wall or column rail mounting



**Keyboard and mouse support options**

**Part Number: WM 335.122**

**Horizontal swivel medical arm 2 x 300 mm for keyboard and mouse, Mounting on Mindray Medical Supply Device**

**Compatible accessories for this 300 mm Horizontal arm**

You can complete your installation with these optional accessories:

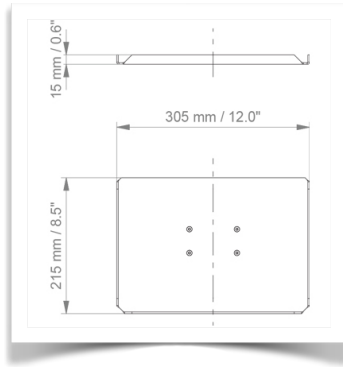

**Keyboard and mouse holder 305 x 215 mm**

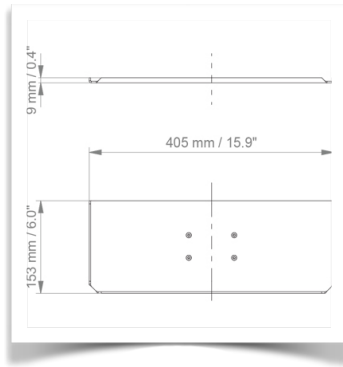

**Keyboard and mouse holder 405 x 153 mm**

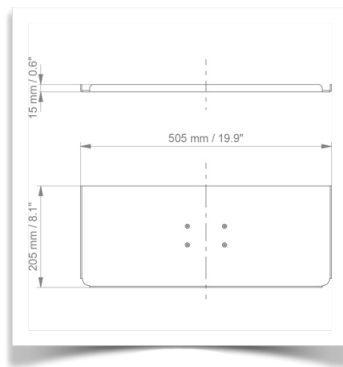

**Keyboard and mouse holder 505 x 205 mm (Standard)**

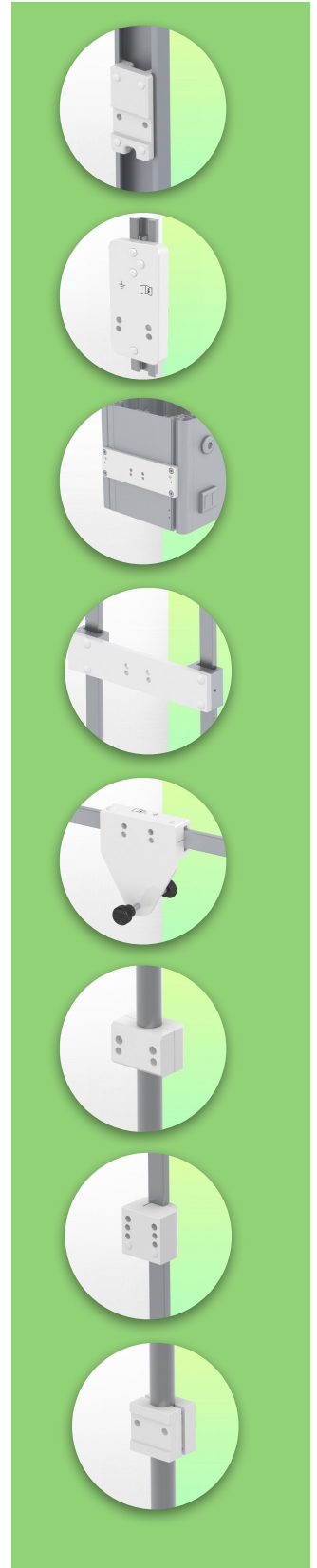

**Keyboard and mouse support options**

**Part Number: WM 335.122**

**Horizontal swivel medical arm 2 x 300 mm for keyboard and mouse, Mounting on Mindray Medical Supply Device**

**Compatible accessories for this 300 mm Horizontal arm**

You can complete your installation with these optional accessories:

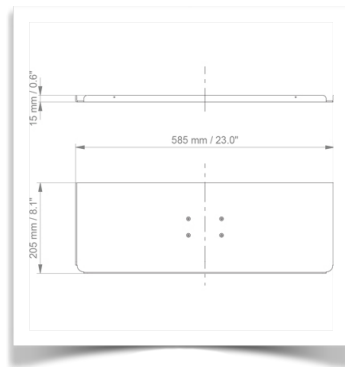

**Keyboard and mouse holder 585 x 205 mm**

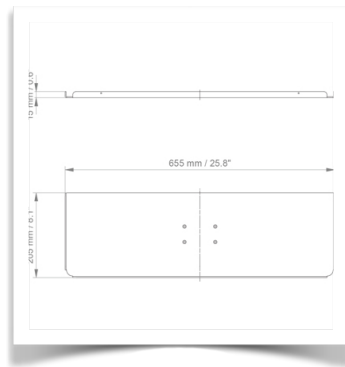

**Keyboard and mouse holder 655 x 205 mm**

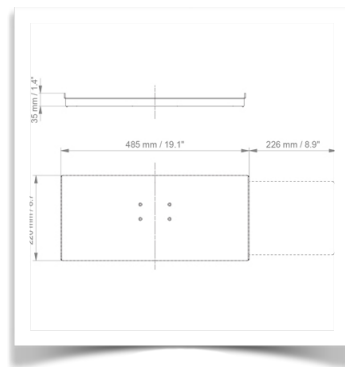

**Sliding keyboard and mouse holder 485 x 220 mm**

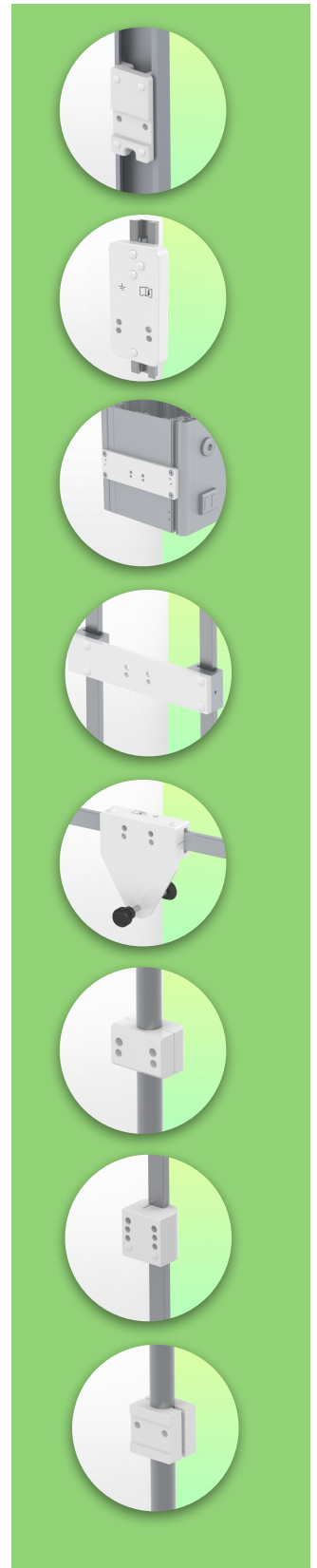



**Keyboard and mouse support options**

**Part Number: WM 335.122**

**Horizontal swivel medical arm 2 x 300 mm for keyboard and mouse, Mounting on Mindray Medical Supply Device**

**Compatible accessories for this 300 mm Horizontal arm**

You can complete your installation with these optional accessories:

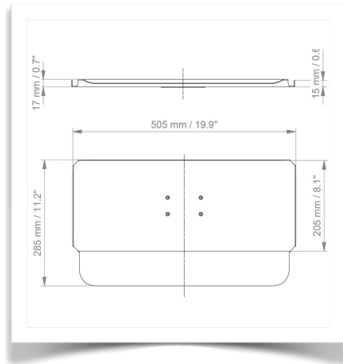

**505 x 205 mm keyboard and mouse stand with wrist rest**

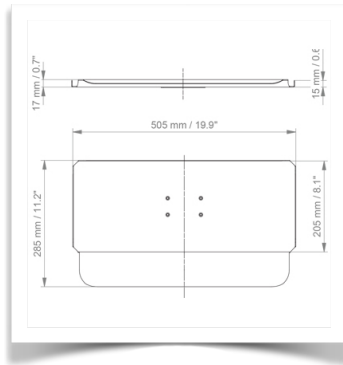

**Keyboard and mouse stand 585 x 205 mm with wrist rest**

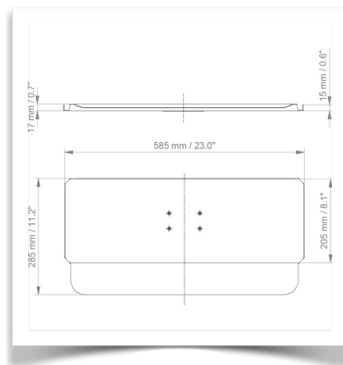

**Keyboard and mouse stand 655 x 205 mm with wrist rest**

