

**Presentation**

**Part Number: WM 335.125**

**300 mm Horizontal Medical Arm for Keyboard and Mouse, Mounting on Anaesthesia Machines (All Manufacturers)**

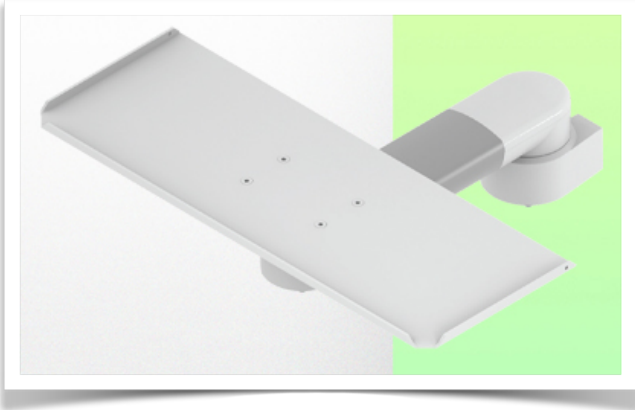

**300 mm Horizontal Medical Arm for Keyboard and Mouse, Mounting on Anaesthesia Machines (All Manufacturers)**

This 300 mm swivel medical arm allows you to fix, orientate and adjust your keyboard and mouse perfectly. It is coated with an anti-microbial agent to ensure hygiene and cleanliness down to the smallest detail.

Its modern design has been specially developed for healthcare environments.

**Technical features:**

- \* Integrated cable management
  - \* Attachment to anaesthesia machine (all manufacturers)
  - \* This 300 mm swivel arm simply slides into the machine's existing rail.
  - \* The keyboard and mouse support supplied in this version has the following dimensions: 500 x 200 mm (other keyboard support configurations are also available, see following pages)
  - \* The weight of the arm is 16 kg.
  - \* Keyboard support rotation: +78° -258°.
  - \* Arm rotation: 105° to the right, 105° to the left.
  - \* Total length 379 mm \* Colour RAL 7024 (Graphite grey) and White
  - \* All our medical arms are CE, ROHS, Medical Grade, MDD 93/42 ECC compliant.
  - \* Warranty: 5 years
- \* 240 mm version also available

**Technical Specifications**

**Part Number: WM 335.125**

**300 mm Horizontal Medical Arm for Keyboard and Mouse, Mounting on Anaesthesia Machines (All Manufacturers)**

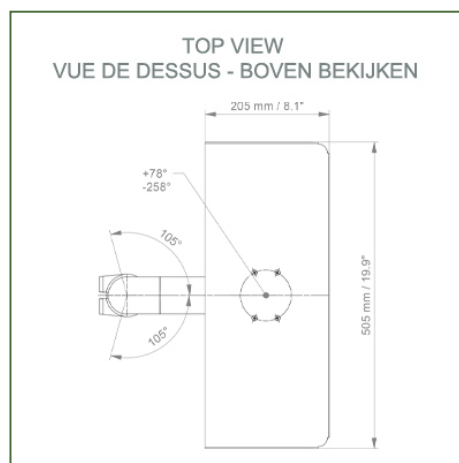
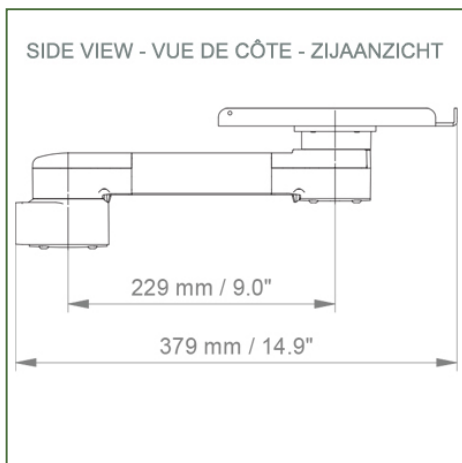
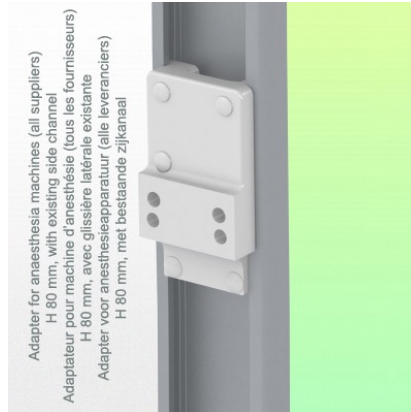
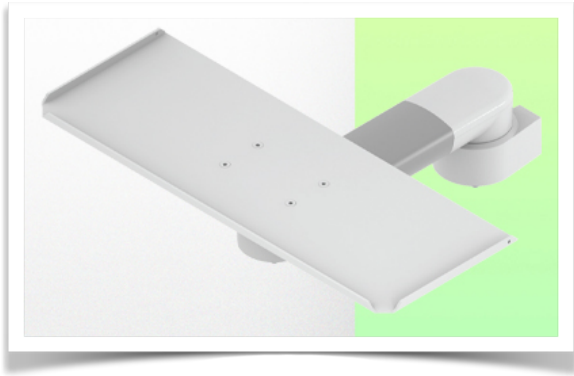

**Keyboard stand dimensions: 500 x 200 mm**

**Colour: Decorative parts: RAL 5013 cobalt blue**

**Aluminium parts: RAL 9016 traffic white**

**Max. load capacity of support arm: 16 kg**

**Tray load capacity: 5 Kg**

**Product weight: between 1.9 and 3.4 Kg depending on the choice of keyboard and mouse tray**

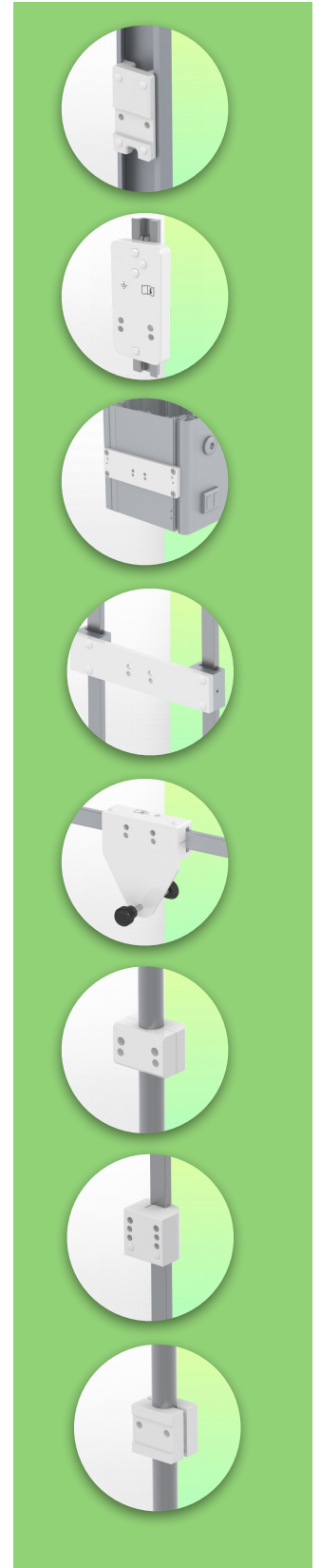

**Mounting Information - Adapter Anesthesia Machines**

**Part Number: WM 335.125**

**300 mm Horizontal Medical Arm for Keyboard and Mouse, Mounting on Anaesthesia Machines (All Manufacturers)**

**Adapter Anesthesia Machines:**

Mounting on Anaesthesia Machines (All Manufacturers)

Mounting on the existing rail of the anaesthesia machine with this adapter



**Mounting information - Mounting options**

**Part Number: WM 335.125**

**300 mm Horizontal Medical Arm for Keyboard and Mouse, Mounting on Anaesthesia Machines (All Manufacturers)**

**Where do you want to mount the support arm?**

At the hospital, there are different ways to fix our brackets: round tube, standard rail, wall rail or on an anaesthesia machine. We will always provide you with the adapter you need.



**Adapter for vertical wall slide**  
For wall slide mounting



**Adapter for Amico remote controls and wall panels**



**Adapter for Mindray medical power supply units**

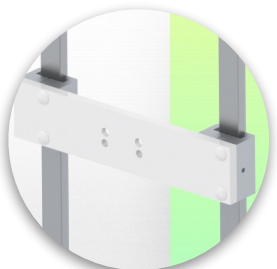

**Double clamp for vertical standard rail**  
For mounting on two parallel vertical standard rails 10 x 25 mm

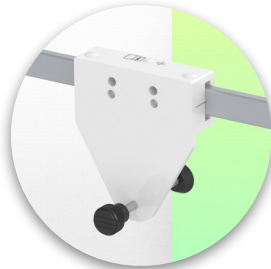

**Fixed clamp for a standard rail**  
For mounting on a horizontal standard rail 10 x 25, 8 x 35, 10 x 30, 10 x 50 mm

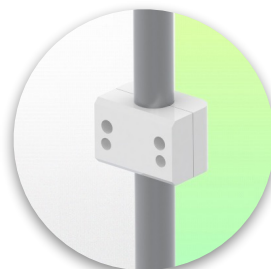

**Fixed clamp for round tube**  
For mounting on round tube  $\varnothing$  25, 35, 38 mm



**Adapter for Maquet anaesthesia machines**  
Cone Adapter for Model FLOW i



**Adapter for Löwenstein anaesthesia machines**  
Medical Adapter for Leon / Leon plus

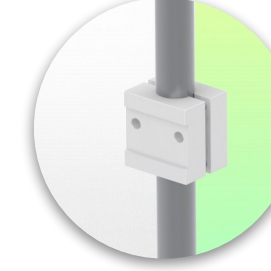

**Universal round tube clamp**  
V-clamp for mounting on round tube  $\varnothing$  23 - 40 mm



**Mounting information - Mounting options**

**Part Number: WM 335.125**

**300 mm Horizontal Medical Arm for Keyboard and Mouse, Mounting on Anaesthesia Machines (All Manufacturers)**

**Where do you want to mount the support arm?**

At the hospital, there are different ways to fix our brackets: round tube, standard rail, wall rail or on an anaesthesia machine. We will always provide you with the adapter you need.



**Adapter for anaesthesia machine (all suppliers)**

H 80 mm, with existing side rail



**Clamp for a vertical standard rail**

For mounting on standard rail 10 x 25 mm



Considered to be the world's best in advanced hygiene control, our medical mounting systems include cable integration, a 5-year maintenance-free warranty and medical grade compliance. We're simply the best in the world at what we do.





Compatible accessories for this mount

Part Number: WM 335.125

**300 mm Horizontal Medical Arm for Keyboard and Mouse, Mounting on Anaesthesia Machines (All Manufacturers)**

Compatible accessories for this 300 mm Horizontal Arm

You

can



**Triple hook for cable**  
For mounting on support arm



**Double hook for cable**  
For mounting on support arm



**Downward pole with cable hook**  
For mounting on support arm

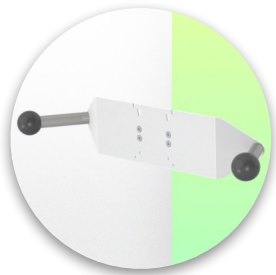

**Double handle with VESA mounting**  
For VESA monitors



**Handle for VESA monitor support**  
For VESA monitors



**Double hook for cable**  
For wall or column rail mounting



**Triple hook for cable**  
For wall or column rail mounting



**Basket**  
For wall or column rail mounting



**Downward Pole**  
For wall or column rail mounting

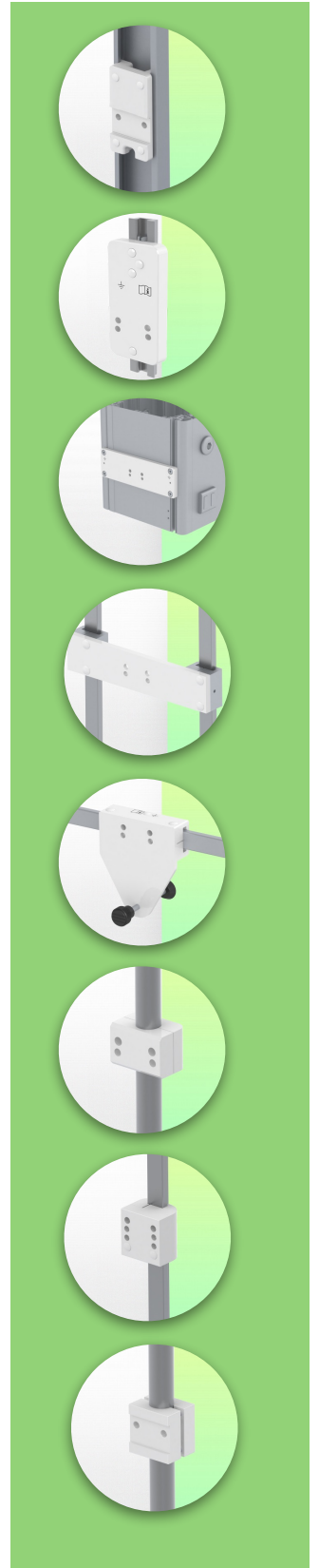

**Keyboard and mouse support options**

**Part Number: WM 335.125**

**300 mm Horizontal Medical Arm for Keyboard and Mouse, Mounting on Anaesthesia Machines (All Manufacturers)**

**Compatible accessories for this 300 mm Horizontal arm**

You can complete your installation with these optional accessories:

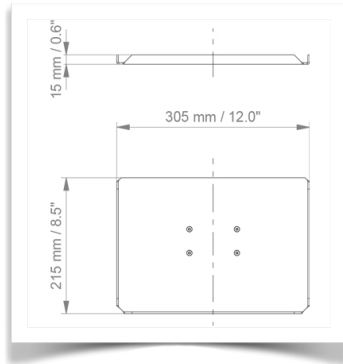

**Keyboard and mouse holder 305 x 215 mm**

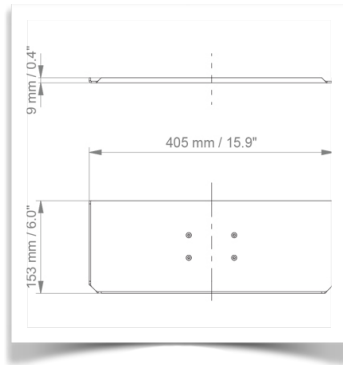

**Keyboard and mouse holder 405 x 153 mm**

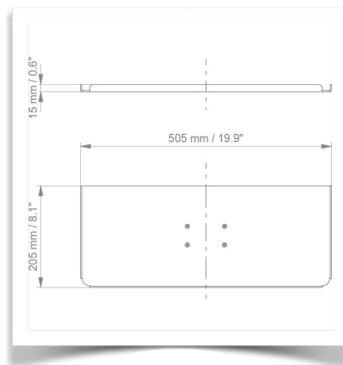

**Keyboard and mouse holder 505 x 205 mm (Standard)**

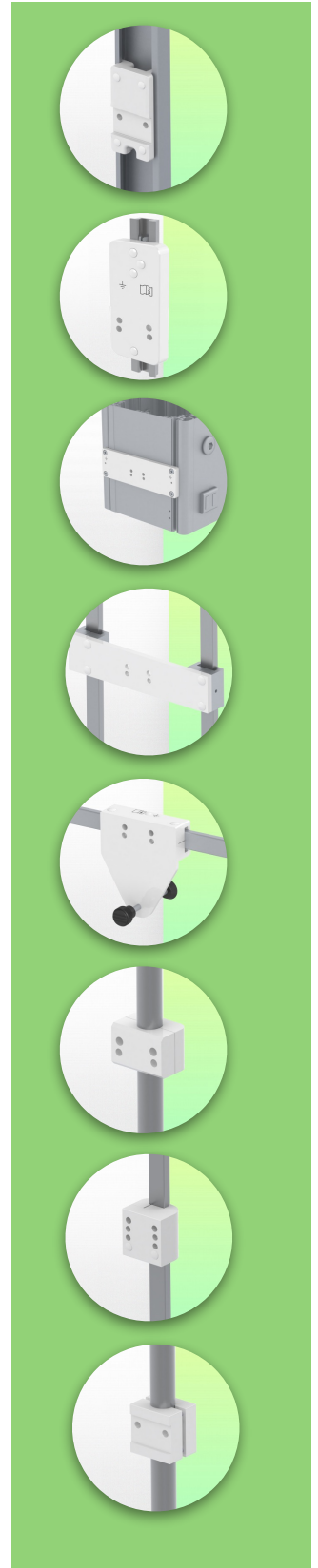

**Keyboard and mouse support options**

**Part Number: WM 335.125**

**300 mm Horizontal Medical Arm for Keyboard and Mouse, Mounting on Anaesthesia Machines (All Manufacturers)**

**Compatible accessories for this 300 mm Horizontal arm**

You can complete your installation with these optional accessories:

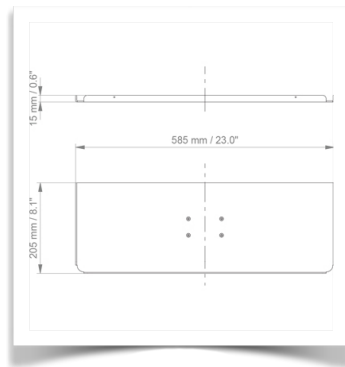

**Keyboard and mouse holder 585 x 205 mm**

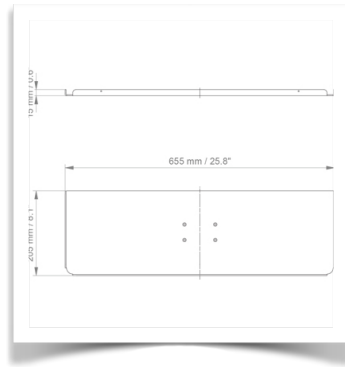

**Keyboard and mouse holder 655 x 205 mm**

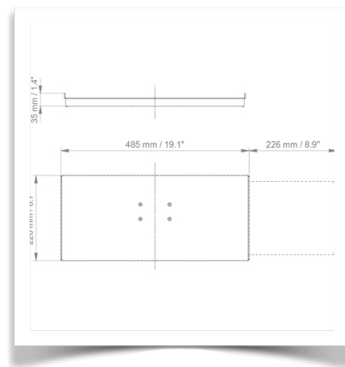

**Sliding keyboard and mouse holder 485 x 220 mm**

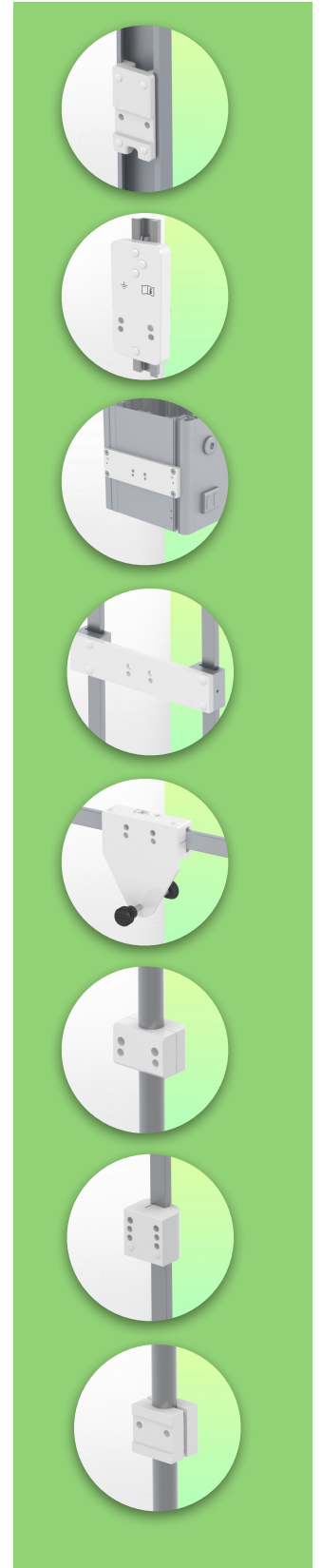



**Keyboard and mouse support options**

**Part Number: WM 335.125**

**300 mm Horizontal Medical Arm for Keyboard and Mouse, Mounting on Anaesthesia Machines (All Manufacturers)**

**Compatible accessories for this 300 mm Horizontal arm**

You can complete your installation with these optional accessories:

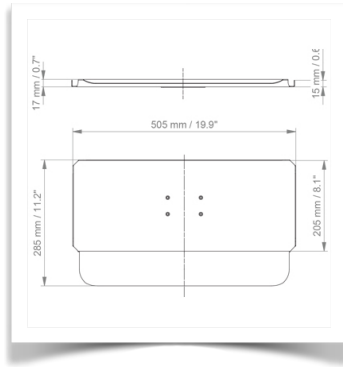

**505 x 205 mm keyboard and mouse stand with wrist rest**

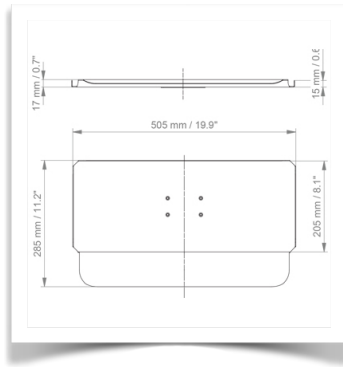

**Keyboard and mouse stand 585 x 205 mm with wrist rest**



**Keyboard and mouse stand 655 x 205 mm with wrist rest**

