

Presentation

Part Number: WM 335.128

Horizontal swivel medical arm 2 x 300 mm for keyboard and mouse, table column mount

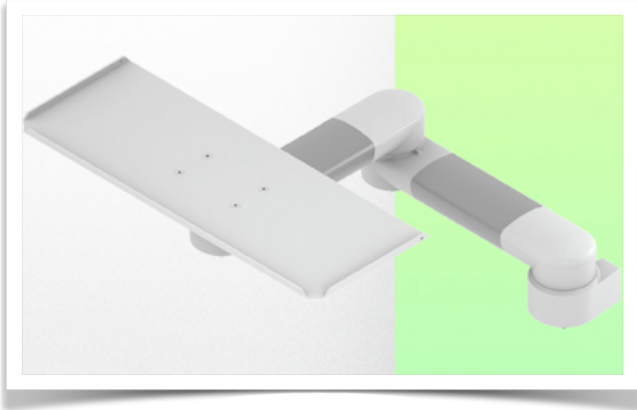

Cette colonne possède deux rails de fixation pour les différents éléments qui y seront fixés.
1 rail à l'avant de la colonne,
1 rail à l'arrière

Deze kolom heeft twee bevestigings rails voor de verschillende elementen die eraan zullen worden bevestigd.
1 rail aan de voorkant van de kolom,
1 rail aan de achterkant

This column has two fixing rails for the various elements that will be fixed to it. 1 rail at the front of the column,
1 rail at the back)

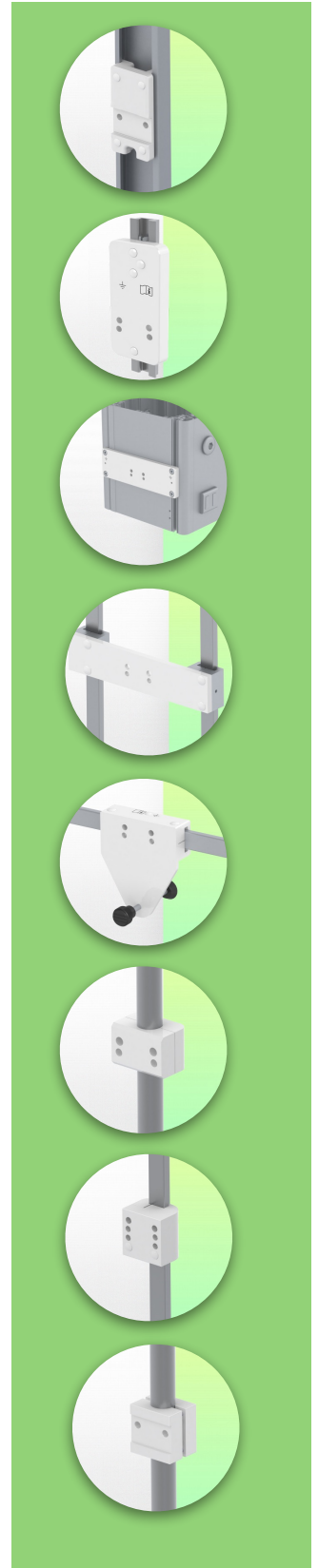
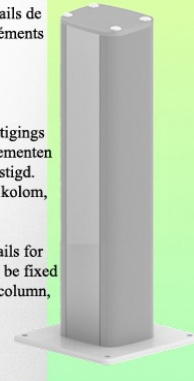

Horizontal swivel medical arm 2 x 300 mm for keyboard and mouse, table column mount

This 2 x 300 mm swivel medical arm allows you to fix, orientate and adjust your keyboard and mouse perfectly. It is coated with an anti-microbial agent to ensure hygiene and cleanliness down to the smallest detail. Its modern design has been specially developed for healthcare environments.

Technical features:

- * Integrated cable management
- * Mounted on table column
- * The 2 x 300mm swivel arm simply clips onto the table column.
- * The keyboard and mouse support supplied in this version has the following dimensions
dimensions: 500 x 200 mm (other keyboard support configurations are also available, see following pages)
- * The weight supported by the arm is 6 kg.
- * Keyboard support rotation: +78° -258°.
- * Arm rotation: 105° to the right, 105° to the left.
- * Total length 608 mm * Colour RAL 7024 (Graphite grey) and White
- * All our medical arms are CE, ROHS, Medical Grade, MDD 93/42 ECC compliant.
- * Warranty: 5 years
- * 240 mm version also available

Technical Specifications

Part Number: WM 335.128

Horizontal swivel medical arm 2 x 300 mm for keyboard and mouse, table column mount

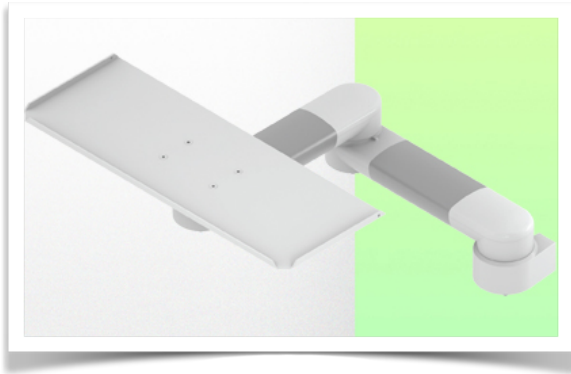

Cette colonne possède deux rails de fixation pour les différents éléments qui y seront fixés.

1 rail à l'avant de la colonne,
1 rail à l'arrière

Deze kolom heeft twee bevestigings rails voor de verschillende elementen die eraan zullen worden bevestigd.

1 rail aan de voorkant van de kolom,
1 rail aan de achterkant

This column has two fixing rails for the various elements that will be fixed to it. 1 rail at the front of the column,
1 rail at the back)

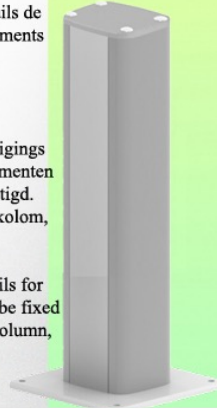

SIDE VIEW - VUE DE CÔTE - ZIJAAZICHT

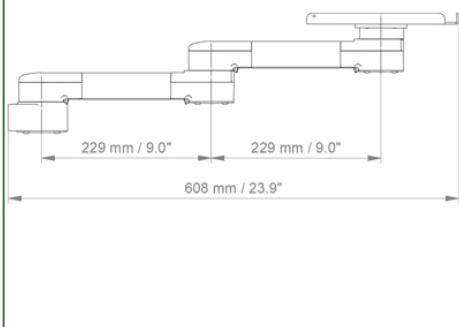

TOP VIEW
VUE DE DESSUS - BOVEN BEKIJKEN

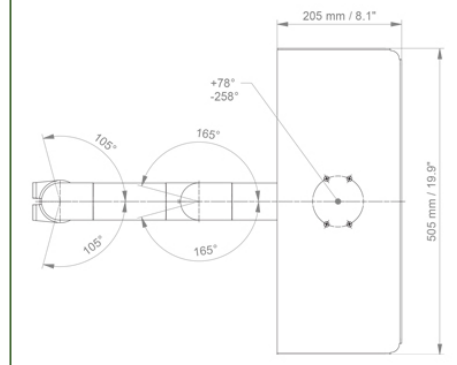

Keyboard stand dimensions: 500 x 200 mm

Colour: Decorative parts: RAL 5013 cobalt blue

Aluminium parts: RAL 9016 traffic white

Max. load capacity of support arm: 6 kg

Tray load capacity: 5 Kg

Product weight: between 1.9 and 3.4 Kg depending on the choice of keyboard and mouse tray

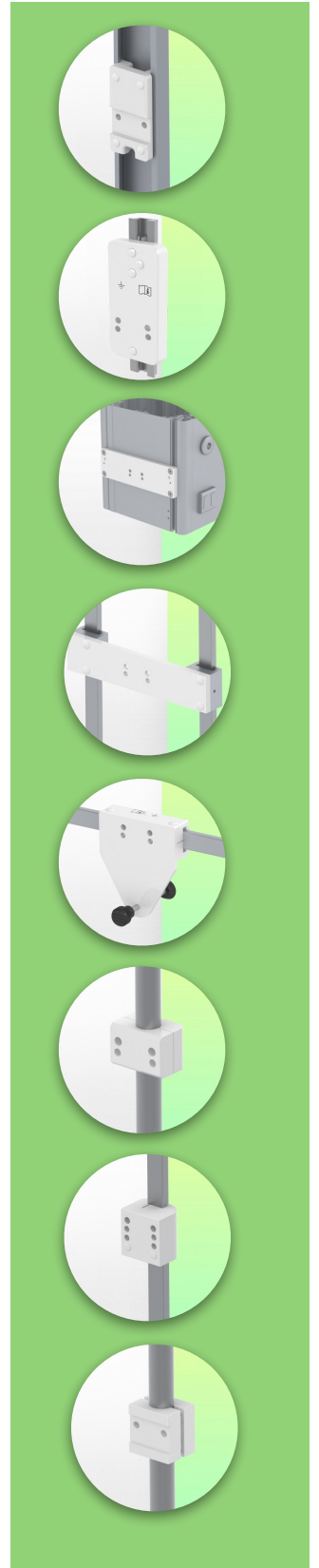

Mounting Information - Wall Slide Rail

Part Number: WM 335.128

Horizontal swivel medical arm 2 x 300 mm for keyboard and mouse, table column mount

Table column:

To install this medical arm, you need to use one of our medical columns. These are available in standard heights of 500 and 300 mm. Custom heights are available on request. Slide covers and end caps are supplied with every order.

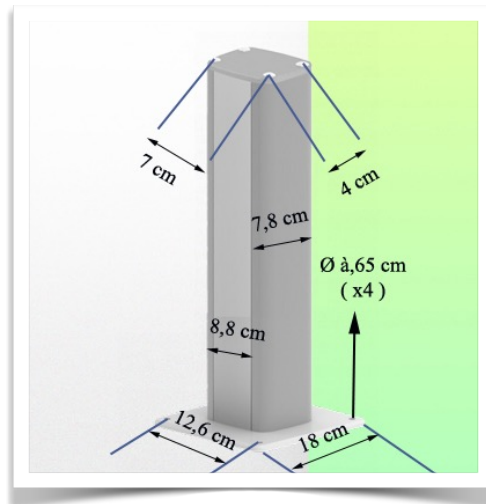
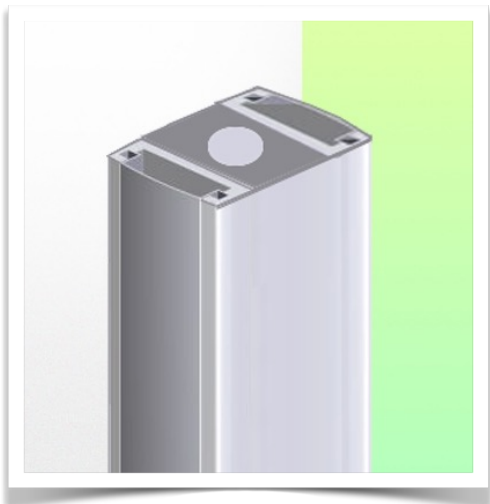
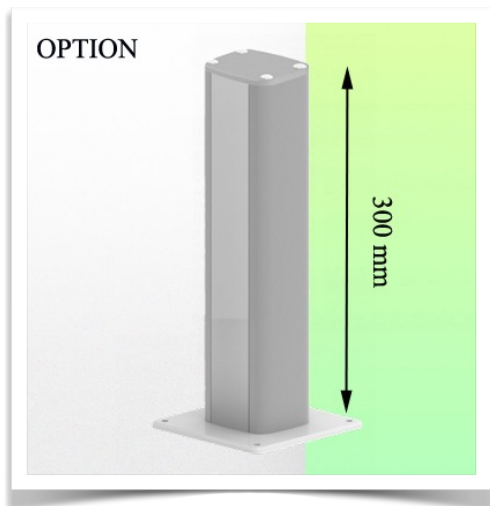

Mounting information - Mounting options

Part Number: WM 335.128

Horizontal swivel medical arm 2 x 300 mm for keyboard and mouse, table column mount

Where do you want to mount the support arm?

At the hospital, there are different ways to fix our brackets: round tube, standard rail, wall rail or on an anaesthesia machine. We will always provide you with the adapter you need.

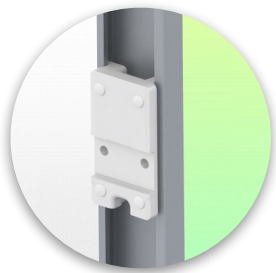

Adapter for vertical wall slide
For wall slide mounting



Adapter for Amico remote controls and wall panels



Adapter for Mindray medical power supply units



Double clamp for vertical standard rail
For mounting on two parallel vertical standard rails 10 x 25 mm



Fixed clamp for a standard rail
For mounting on a horizontal standard rail 10 x 25, 8 x 35, 10 x 30, 10 x 50 mm



Fixed clamp for round tube
For mounting on round tube \varnothing 25, 35, 38 mm



Adapter for Maquet anaesthesia machines
Cone Adapter for Model FLOW i



Adapter for Löwenstein anaesthesia machines
Medical Adapter for Leon / Leon plus



Universal round tube clamp
V-clamp for mounting on round tube \varnothing 23 - 40 mm



Mounting information - Mounting options

Part Number: WM 335.128

Horizontal swivel medical arm 2 x 300 mm for keyboard and mouse, table column mount

Where do you want to mount the support arm?

At the hospital, there are different ways to fix our brackets: round tube, standard rail, wall rail or on an anaesthesia machine. We will always provide you with the adapter you need.



Adapter for anaesthesia machine (all suppliers)



Clamp for a vertical standard rail

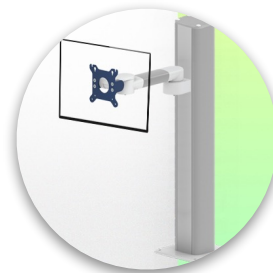
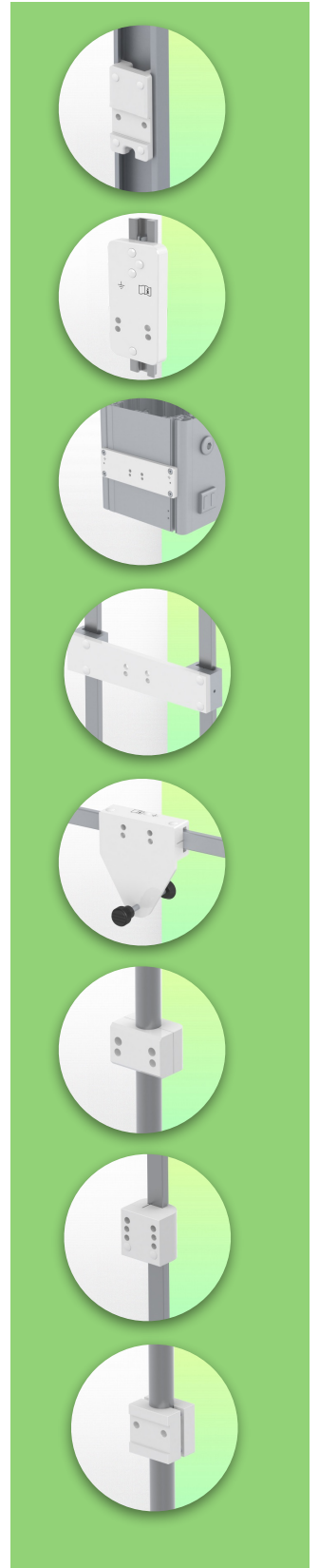

Table column
500 mm or 300 mm

For



Considered to be the world's best in advanced hygiene control, our medical mounting systems include cable integration, a 5-year maintenance-free warranty and medical grade compliance. We're simply the best in the world at what we do.



Compatible accessories for this mount

Part Number: WM 335.128

Horizontal swivel medical arm 2 x 300 mm for keyboard and mouse, table column mount

Compatible accessories for this 300 mm Horizontal Arm

You can complete your installation with these additional accessories:



Triple hook for cable For mounting on support arm



Double hook for cable For mounting on support arm



Downward pole with cable hook For mounting on support arm



Double handle with VESA mounting For VESA monitors



Handle for VESA monitor support For VESA monitors



Double hook for cable For mounting on a wall or column rail



Triple hook for cable For wall or column rail mounting



Basket For wall or column rail mounting



Downward Pole For mounting on support arm



Keyboard and mouse support options

Part Number: WM 335.128

Horizontal swivel medical arm 2 x 300 mm for keyboard and mouse, table column mount

Compatible accessories for this 300 mm Horizontal arm

You can complete your installation with these optional accessories:

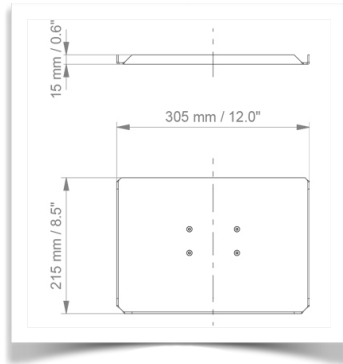

Keyboard and mouse holder 305 x 215 mm

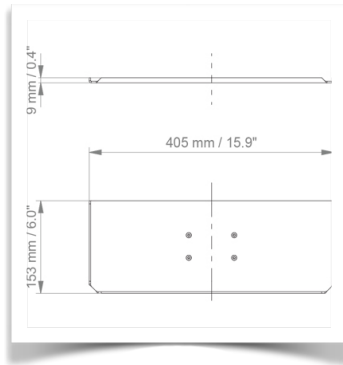

Keyboard and mouse holder 405 x 153 mm

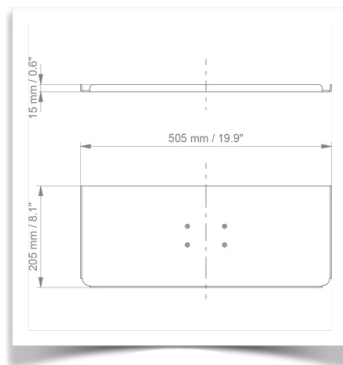

Keyboard and mouse holder 505 x 205 mm (Standard)

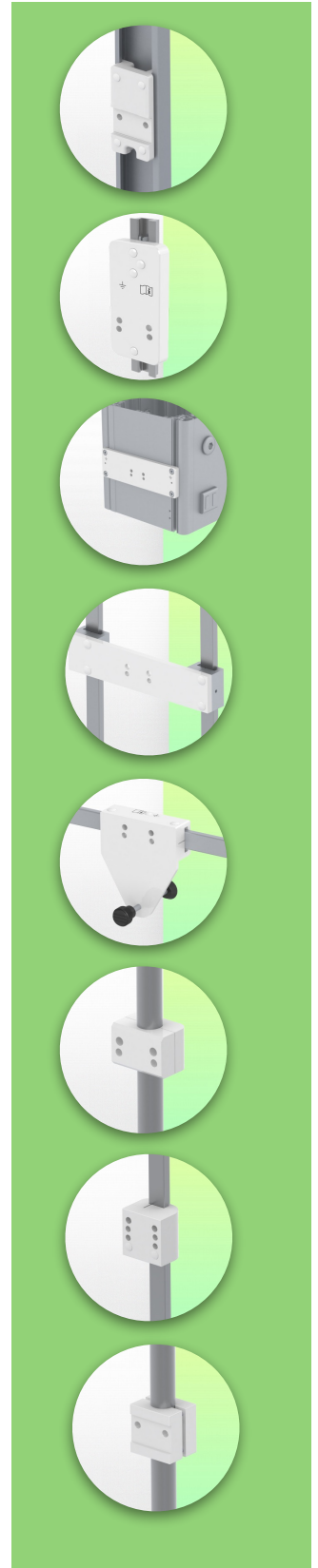

Keyboard and mouse support options

Part Number: WM 335.128

Horizontal swivel medical arm 2 x 300 mm for keyboard and mouse, table column mount

Compatible accessories for this 300 mm Horizontal arm

You can complete your installation with these optional accessories:

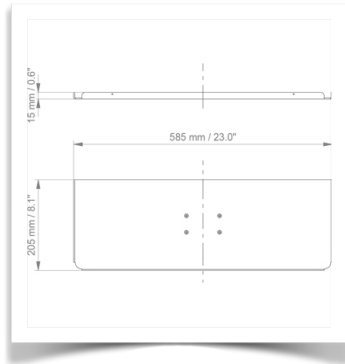

Keyboard and mouse holder 585 x 205 mm

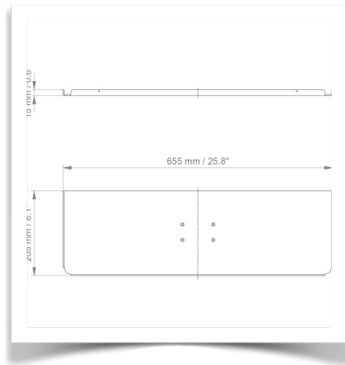

Keyboard and mouse holder 655 x 205 mm

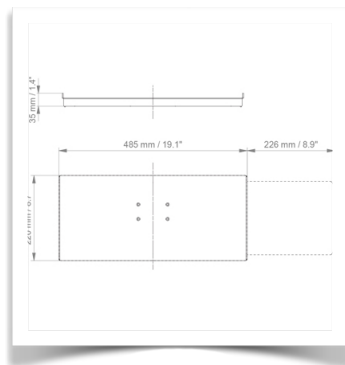

Sliding keyboard and mouse holder 485 x 220 mm

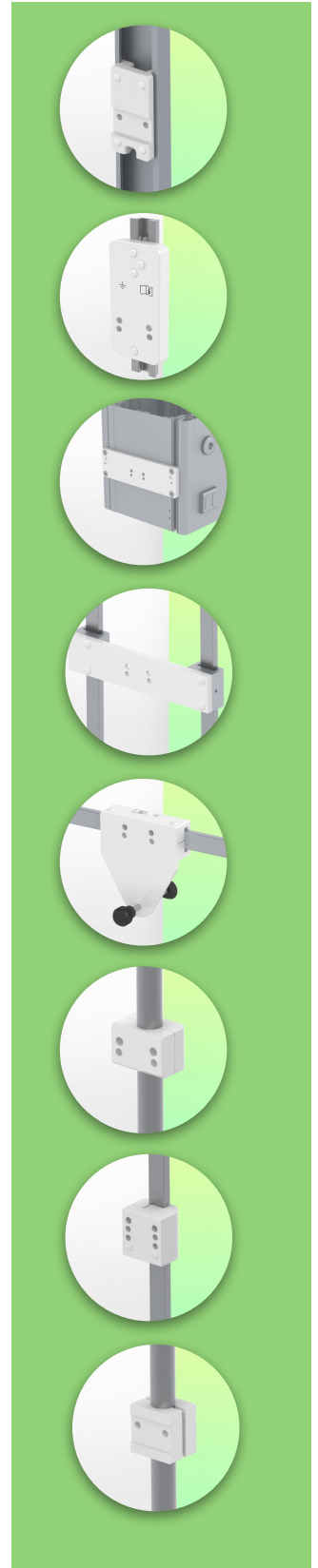

Keyboard and mouse support options

Part Number: WM 335.128

Horizontal swivel medical arm 2 x 300 mm for keyboard and mouse, table column mount

Compatible accessories for this 300 mm Horizontal arm

You can complete your installation with these optional accessories:

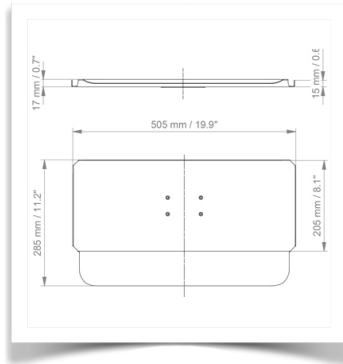

505 x 205 mm keyboard and mouse stand with wrist rest

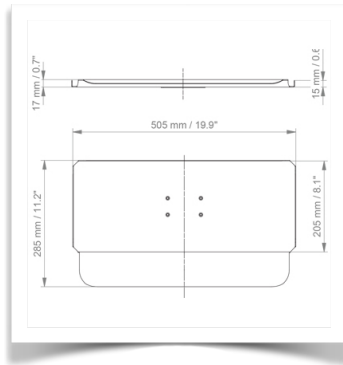

Keyboard and mouse stand 585 x 205 mm with wrist rest

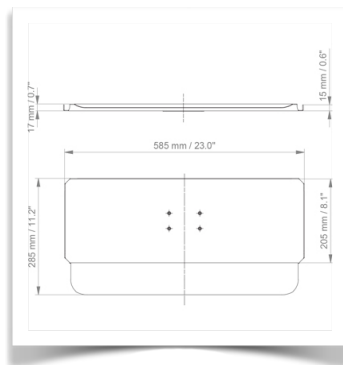

Keyboard and mouse stand 655 x 205 mm with wrist rest

