

Presentation

Part Number: WM 335.133

Height-adjustable medical arm, length 300 mm for keyboard and mouse, Mounting on Mindray Medical Power Supply Device. Supported weight balancing range from 0 to 4 Kg

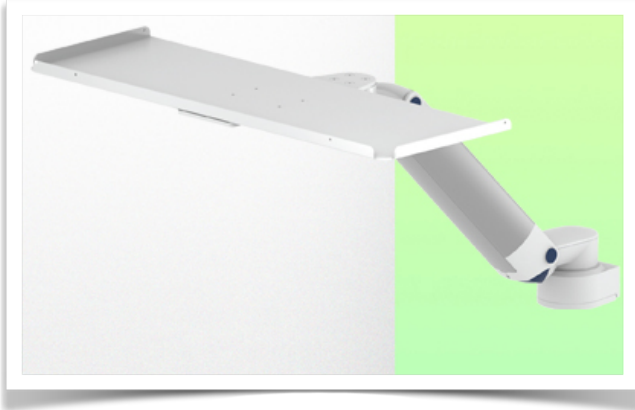

Height-adjustable medical arm, length 300 mm for keyboard and mouse, Mounting on Mindray Medical Power Supply Device. Supported weight balancing range from 0 to 4 Kg

Full cable integration and infection prevention thanks to easy-to-clean surfaces make this arm ideal for emergency care areas. Height adjustment for ergonomic, customised positioning of keyboard and mouse. This 300 mm Horizontal Medical Arm with gas-lift height adjustment enables the keyboard to be fixed, oriented and adjusted perfectly. It is coated with an anti-microbial agent to ensure hygiene and cleanliness down to the smallest detail. Its modern design has been specially developed for healthcare environments.

Technical specifications:

- * Integrated cable passage
- * Equipotential bonding * Fixing to the chosen adapter solution Mindray
- * This 300 mm gas strut Horizontal Arm simply adjusts to the required height and fixed.
- * It has a safety stop button for height adjustment, which allows the arm to remain in the chosen position.
- * Arm balance scale 0-4 Kg.
- * Arm rotation: 90° to the right, 90° to the left from the fixing point.
- * Height adjustment: 45° down, 45° up
- * Total length 772 mm including keyboard support
- * Standard Mouse Keyboard Support 500 x 200 mm
- * All our medical arms comply with: CE, ROHS, Medical Grade, Regulations MDD 93/42 ECC
- * Colour RAL 5013 cobalt blue and RAL 9016 traffic white
- * Warranty: 5 years

Technical Specifications

Part Number: WM 335.133

Height-adjustable medical arm, length 300 mm for keyboard and mouse, Mounting on Mindray Medical Power Supply Device. Supported weight balancing range from 0 to 4 Kg

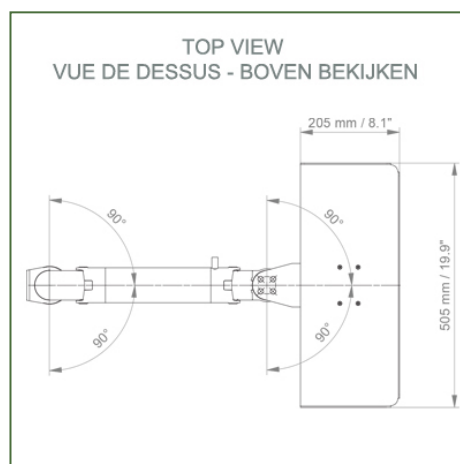
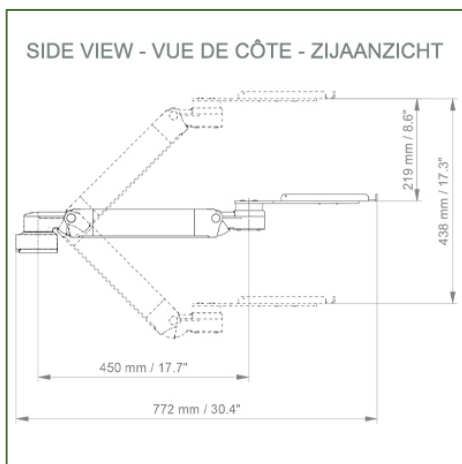
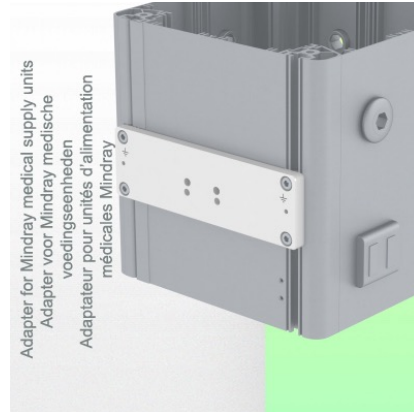
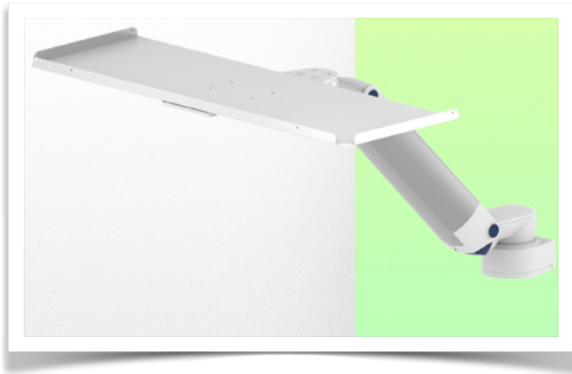

Balance scale for this medical arm: 0 - 4 Kg Product weight: 4.4 - 6.0 kg / (depending on keyboard tray dimensions)

Maximum load capacity of support arm: 20 Kg

Height adjustment: parallel mechanism for perfect fit

Safety: has a safety stop button for height adjustment, allowing the medical arm to remain in the selected position.



Mounting Information - Adapter Mindray

Part Number: WM 335.133

Height-adjustable medical arm, length 300 mm for keyboard and mouse, Mounting on Mindray Medical Power Supply Device. Supported weight balancing range from 0 to 4 Kg

Adapter Mindray:

Mounting on Mindray Medical Supply Device

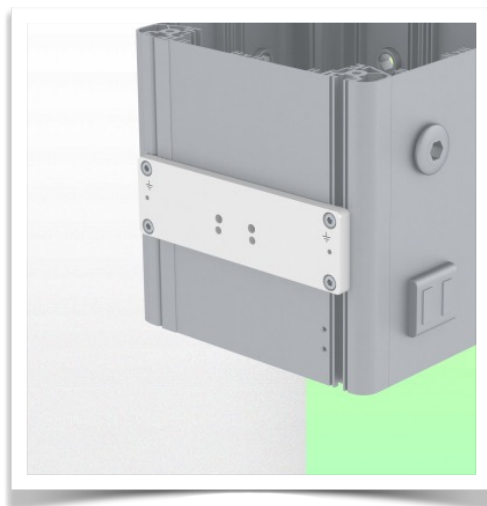
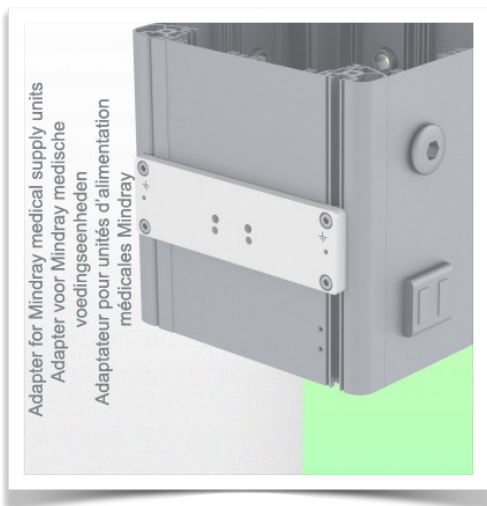

Mounting information - Mounting options

Part Number: WM 335.133

Height-adjustable medical arm, length 300 mm for keyboard and mouse, Mounting on Mindray Medical Power Supply Device. Supported weight balancing range from 0 to 4 Kg

Where do you want to mount the support arm?

At the hospital, there are different ways to fix our brackets: round tube, standard rail, wall rail or on an anaesthesia machine. We will always provide you with the adapter you need.

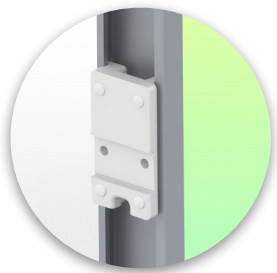

Adapter for vertical wall slide
For wall slide mounting



Adapter for Amico remote controls and wall panels



Adapter for Mindray medical power supply units

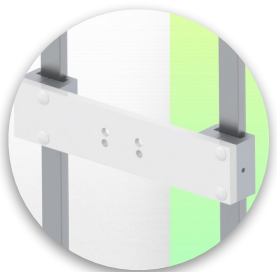

Double clamp for vertical standard rail
For mounting on two parallel vertical standard rails 10 x 25 mm



Fixed clamp for a standard rail
For mounting on a horizontal standard rail 10 x 25, 8 x 35, 10 x 30, 10 x 50 mm



Fixed clamp for round tube
For mounting on round tube \varnothing 25, 35, 38 mm

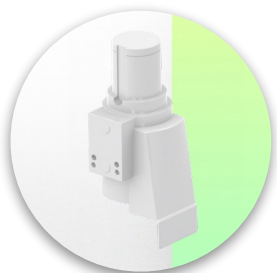

Adapter for Maquet anaesthesia machines
Cone Adapter for Model FLOW i



Adapter for Löwenstein anaesthesia machines
Medical Adapter for Leon / Leon plus

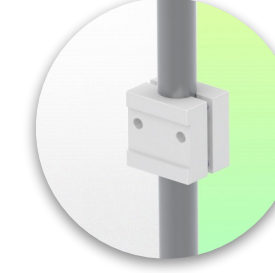

Universal round tube clamp
V-clamp for mounting on round tube \varnothing 23 - 40 mm



Mounting information - Mounting options

Part Number: WM 335.133

Height-adjustable medical arm, length 300 mm for keyboard and mouse, Mounting on Mindray Medical Power Supply Device. Supported weight balancing range from 0 to 4 Kg

Where do you want to mount the support arm?

At the hospital, there are different ways to fix our brackets: round tube, standard rail, wall rail or on an anaesthesia machine. We will always provide you with the adapter you need.



Adapter for anaesthesia machine (all suppliers)

H 80 mm, with existing side rail



Clamp for a vertical standard rail

For mounting on standard rail 10 x 25 mm



Considered to be the world's best in advanced hygiene control, our medical mounting systems include cable integration, a 5-year maintenance-free warranty and medical grade compliance. We're simply the best in the world at what we do.



Compatible accessories for this mount

Part Number: WM 335.133

Height-adjustable medical arm, length 300 mm for keyboard and mouse, Mounting on Mindray Medical Power Supply Device. Supported weight balancing range from 0 to 4 Kg

Compatible accessories for this Medical Arm

You can complete your installation with these additional accessories:



Triple hook for cable
For mounting on support arm



Double hook for cable
For mounting on support arm



Downward pole with cable hook
For mounting on support arm

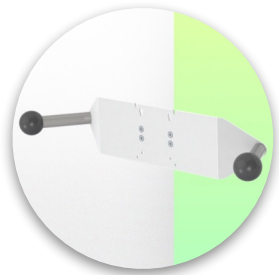

Double handle with VESA mounting
For VESA monitors



Handle for VESA monitor support
For VESA monitors



Double hook for cable
For wall or column rail mounting



Triple hook for cable
For wall or column rail mounting



Basket
For wall or column rail mounting



Downward Pole
For mounting on support arm



Keyboard and mouse support options

Part Number: WM 335.133

Height-adjustable medical arm, length 300 mm for keyboard and mouse, Mounting on Mindray Medical Power Supply Device. Supported weight balancing range from 0 to 4 Kg

Compatible accessories for this 300 mm Horizontal arm

You can complete your installation with these optional accessories:

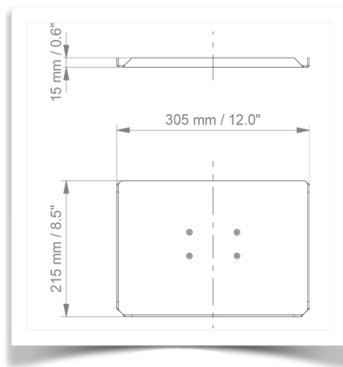

Keyboard and mouse holder 305 x 215 mm

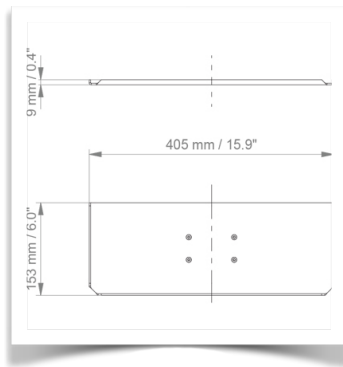

Keyboard and mouse holder 405 x 153 mm

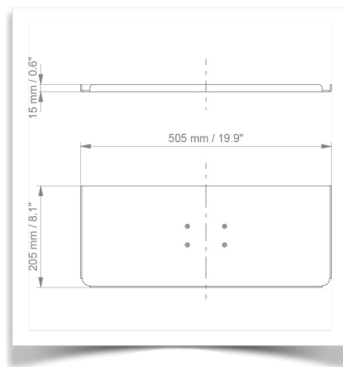

Keyboard and mouse holder 505 x 205 mm (Supplied as standard)

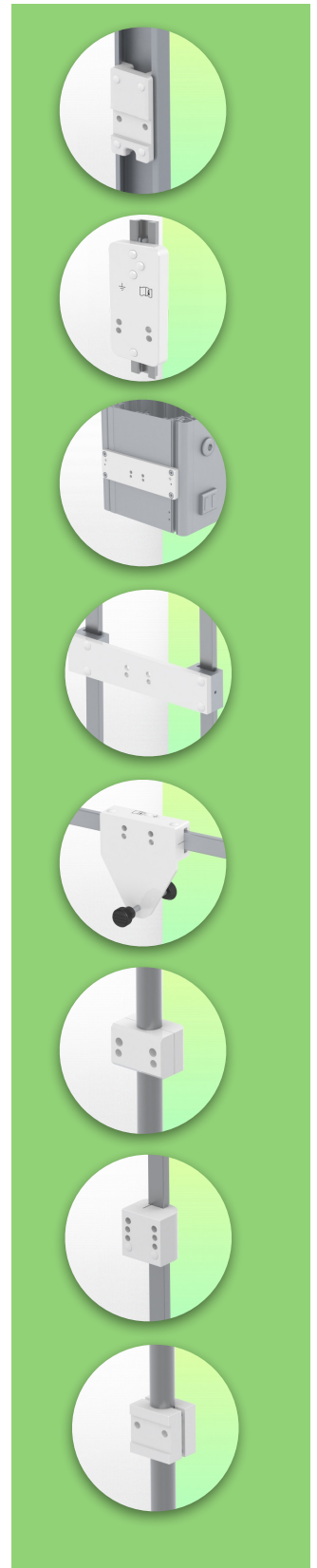

Keyboard and mouse support options

Part Number: WM 335.133

Height-adjustable medical arm, length 300 mm for keyboard and mouse, Mounting on Mindray Medical Power Supply Device. Supported weight balancing range from 0 to 4 Kg

Compatible accessories for this 300 mm Horizontal arm

You can complete your installation with these optional accessories:

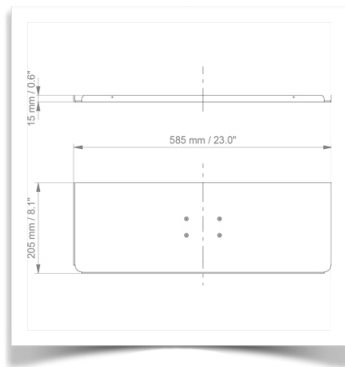

Keyboard and mouse holder 585 x 205 mm

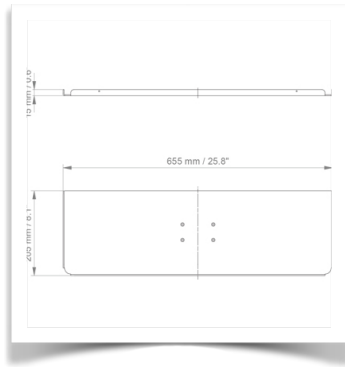

Keyboard and mouse holder 655 x 205 mm

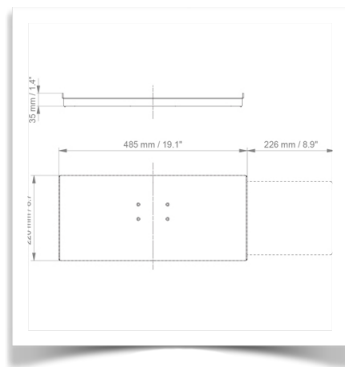

Sliding keyboard and mouse holder 485 x 220 mm

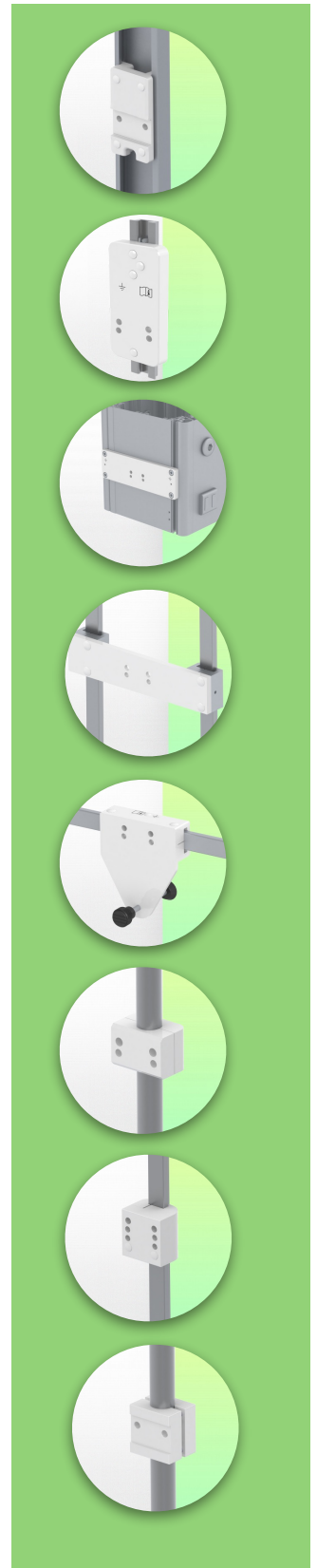

Keyboard and mouse support options

Part Number: WM 335.133

Height-adjustable medical arm, length 300 mm for keyboard and mouse, Mounting on Mindray Medical Power Supply Device. Supported weight balancing range from 0 to 4 Kg

Compatible accessories for this 300 mm Horizontal arm

You can complete your installation with these optional accessories:



505 x 205 mm keyboard and mouse stand with wrist rest

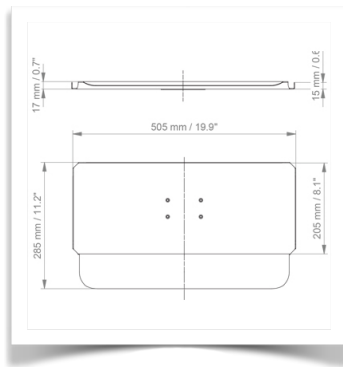

Keyboard and mouse stand 585 x 205 mm with wrist rest



Keyboard and mouse stand 655 x 205 mm with wrist rest

