

**Presentation**

**Part Number: WM 335.137**

**300 mm height-adjustable medical arm for keyboard and mouse, for mounting on anaesthesia machines (all manufacturers). Supported weight balance scale from 0 to 4 Kg**

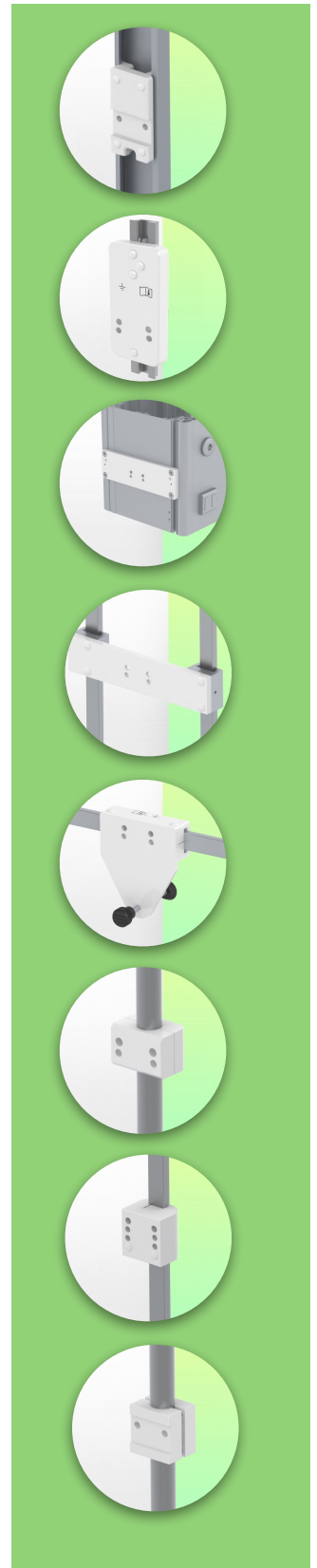
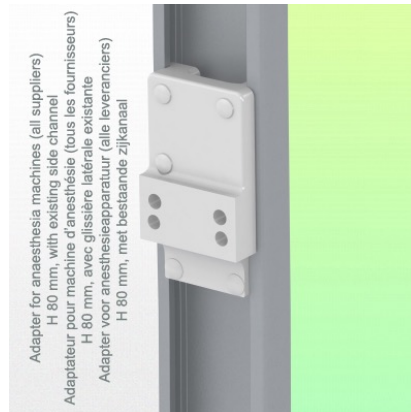
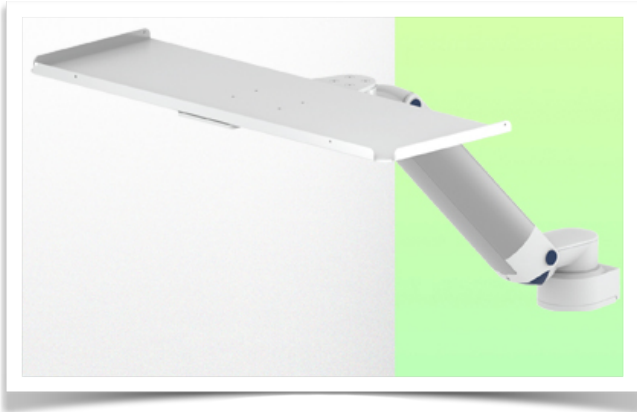

**300 mm height-adjustable medical arm for keyboard and mouse, for mounting on anaesthesia machines (all manufacturers). Supported weight balance scale from 0 to 4 Kg**

Full cable integration and infection prevention thanks to easy-to-clean surfaces make this arm ideal for emergency care areas. Height adjustment for ergonomic, customised positioning of keyboard and mouse. This 300 mm Horizontal Medical Arm with gas-lift height adjustment enables the keyboard to be fixed, oriented and adjusted perfectly. It is coated with an anti-microbial agent to ensure hygiene and cleanliness down to the smallest detail. Its modern design has been specially developed for healthcare environments.

**Technical specifications:**

- \* Integrated cable passage
- \* Equipotential bonding \* Fixing to the chosen adapter solution
- \* This 300 mm gas strut Horizontal Arm simply adjusts to the required height and fixed.
- \* It has a safety stop button for height adjustment, which allows the arm to remain in the chosen position.
- \* Arm balance scale 0-4 Kg.
- \* Arm rotation: 90° to the right, 90° to the left from the fixing point.
- \* Height adjustment: 45° down, 45° up \* Total length 772 mm including keyboard support \* Standard Mouse Keyboard Support 500 x 200 mm
- \* All our medical arms comply with: CE, ROHS, Medical Grade, Regulations MDD 93/42 ECC \* Colour RAL 5013 cobalt blue and RAL 9016 traffic white
- \* Warranty: 5 years

**Technical Specifications**

**Part Number: WM 335.137**

**300 mm height-adjustable medical arm for keyboard and mouse, for mounting on anaesthesia machines (all manufacturers). Supported weight balance scale from 0 to 4 Kg**

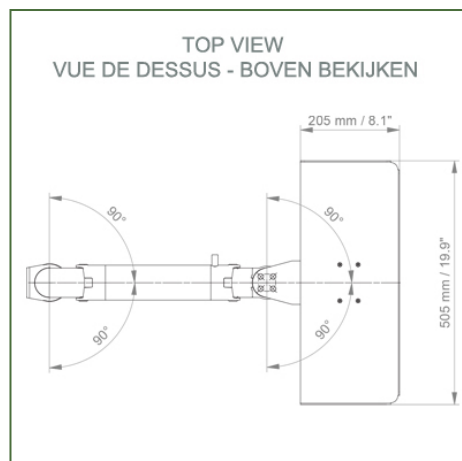
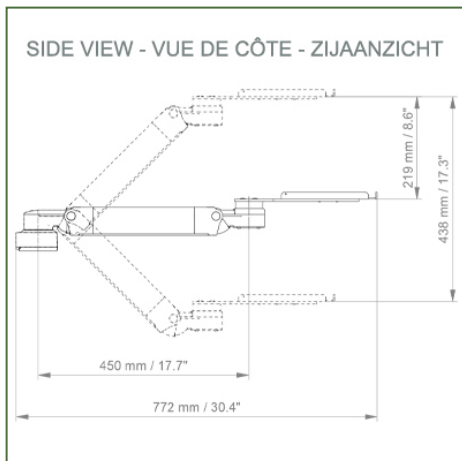
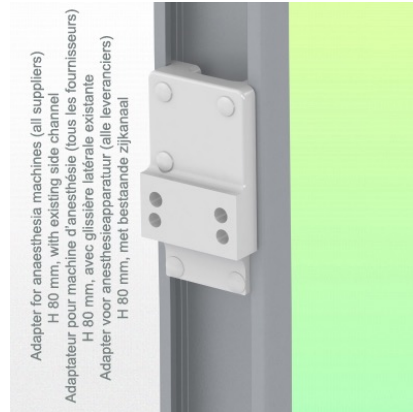
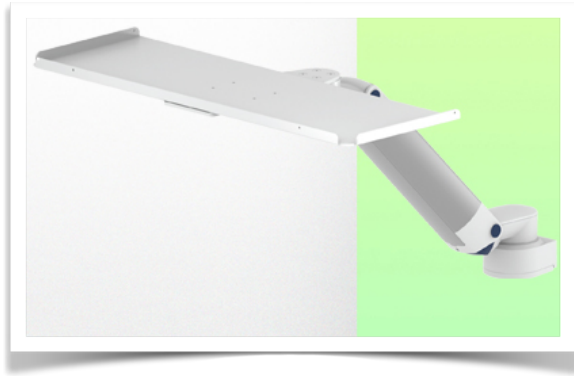

**Balance scale for this medical arm: 0 - 4 Kg Product weight: 4.4 - 6.0 kg / (depending on keyboard tray dimensions)**

**Maximum load capacity of support arm: 20 Kg**

**Height adjustment: parallel mechanism for perfect fit**

**Safety: has a safety stop button for height adjustment, allowing the medical arm to remain in the selected position.**



**Mounting Information - Adapter Anesthesia Machines**

**Part Number: WM 335.137**

**300 mm height-adjustable medical arm for keyboard and mouse, for mounting on anaesthesia machines (all manufacturers). Supported weight balance scale from 0 to 4 Kg**

**Adapter Anesthesia Machines:**

**Mounting on Anaesthesia Machines (All Manufacturers)**



**Mounting information - Mounting options**

**Part Number: WM 335.137**

**300 mm height-adjustable medical arm for keyboard and mouse, for mounting on anaesthesia machines (all manufacturers). Supported weight balance scale from 0 to 4 Kg**

**Where do you want to mount the support arm?**

At the hospital, there are different ways to fix our brackets: round tube, standard rail, wall rail or on an anaesthesia machine. We will always provide you with the adapter you need.



**Adapter for vertical wall slide**  
For wall slide mounting



**Adapter for Amico remote controls and wall panels**



**Adapter for Mindray medical power supply units**



**Double clamp for vertical standard rail**  
For mounting on two parallel vertical standard rails 10 x 25 mm



**Fixed clamp for a standard rail**  
For mounting on a horizontal standard rail 10 x 25, 8 x 35, 10 x 30, 10 x 50 mm



**Fixed clamp for round tube**  
For mounting on round tube  $\varnothing$  25, 35, 38 mm



**Adapter for Maquet anaesthesia machines**  
Cone Adapter for Model FLOW i



**Adapter for Löwenstein anaesthesia machines**  
Medical Adapter for Leon / Leon plus



**Universal round tube clamp**  
V-clamp for mounting on round tube  $\varnothing$  23 - 40 mm



**Mounting information - Mounting options**

**Part Number: WM 335.137**

**300 mm height-adjustable medical arm for keyboard and mouse, for mounting on anaesthesia machines (all manufacturers). Supported weight balance scale from 0 to 4 Kg**

**Where do you want to mount the support arm?**

At the hospital, there are different ways to fix our brackets: round tube, standard rail, wall rail or on an anaesthesia machine. We will always provide you with the adapter you need.



**Adapter for anaesthesia machine (all suppliers)**

H 80 mm, with existing side rail



**Clamp for a vertical standard rail**

For mounting on standard rail 10 x 25 mm



Considered to be the world's best in advanced hygiene control, our medical mounting systems include cable integration, a 5-year maintenance-free warranty and medical grade compliance. We're simply the best in the world at what we do.



**Compatible accessories for this mount**

**Part Number: WM 335.137**

**300 mm height-adjustable medical arm for keyboard and mouse, for mounting on anaesthesia machines (all manufacturers). Supported weight balance scale from 0 to 4 Kg**

**Compatible accessories for this 300 mm Medical Arm**

You can complete your installation with these additional accessories:



**Triple hook for cable**  
For mounting on support arm



**Double hook for cable**  
For mounting on support arm



**Downward pole with cable hook**  
For mounting on support arm

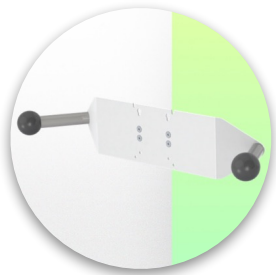

**Double handle with VESA mounting**  
For VESA monitors



**Handle for VESA monitor support**  
For VESA monitors



**Double hook for cable**  
For wall or column rail mounting



**Triple hook for cable**  
For wall or column rail mounting



**Basket**  
For wall or column rail mounting



**Downward Pole**  
For mounting on support arm



**Keyboard and mouse support options**

**Part Number: WM 335.137**

**300 mm height-adjustable medical arm for keyboard and mouse, for mounting on anaesthesia machines (all manufacturers). Supported weight balance scale from 0 to 4 Kg**

**Compatible accessories for this 300 mm Horizontal arm**

You can complete your installation with these optional accessories:

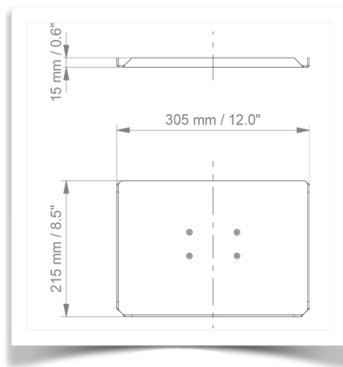

**Keyboard and mouse holder 305 x 215 mm**

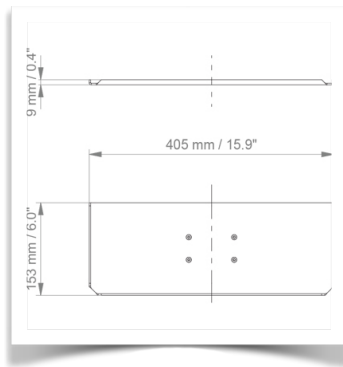

**Keyboard and mouse holder 405 x 153 mm**

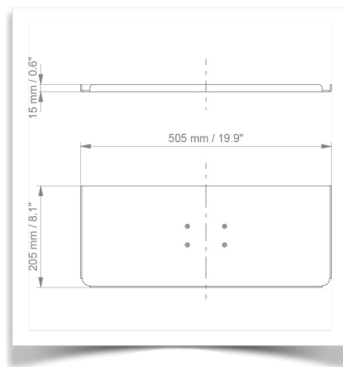

**Keyboard and mouse holder 505 x 205 mm (Supplied as standard)**

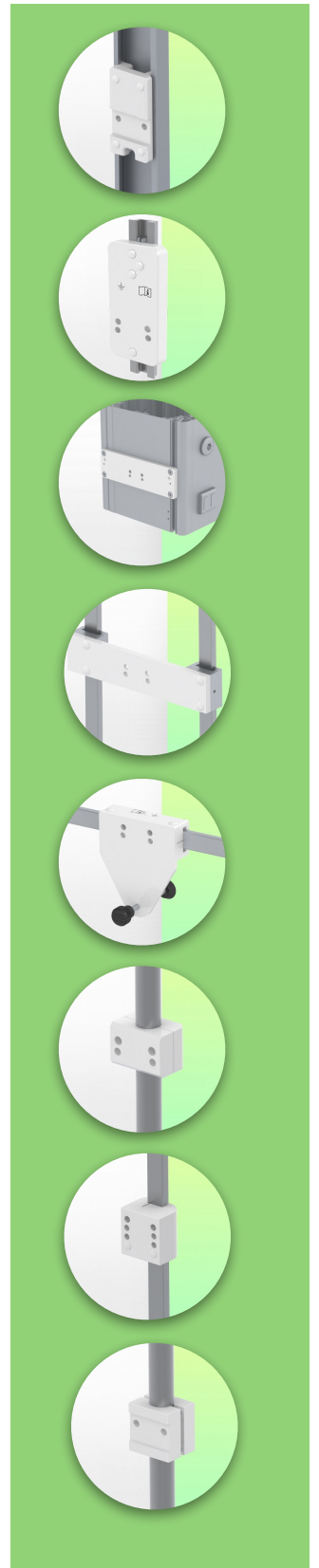

**Keyboard and mouse support options**

**Part Number: WM 335.137**

**300 mm height-adjustable medical arm for keyboard and mouse, for mounting on anaesthesia machines (all manufacturers). Supported weight balance scale from 0 to 4 Kg**

**Compatible accessories for this 300 mm Horizontal arm**

You can complete your installation with these optional accessories:

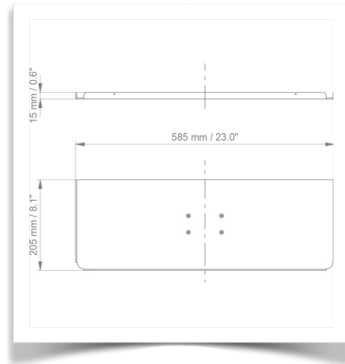

**Keyboard and mouse holder 585 x 205 mm**

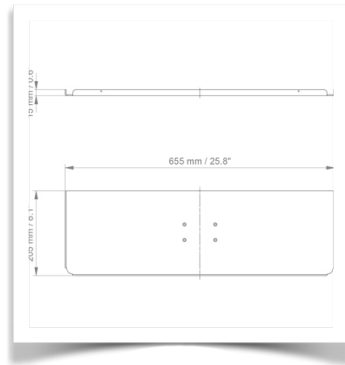

**Keyboard and mouse holder 655 x 205 mm**

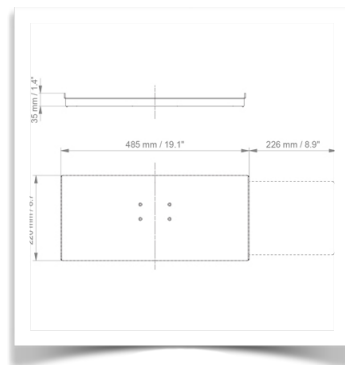

**Sliding keyboard and mouse holder 485 x 220 mm**

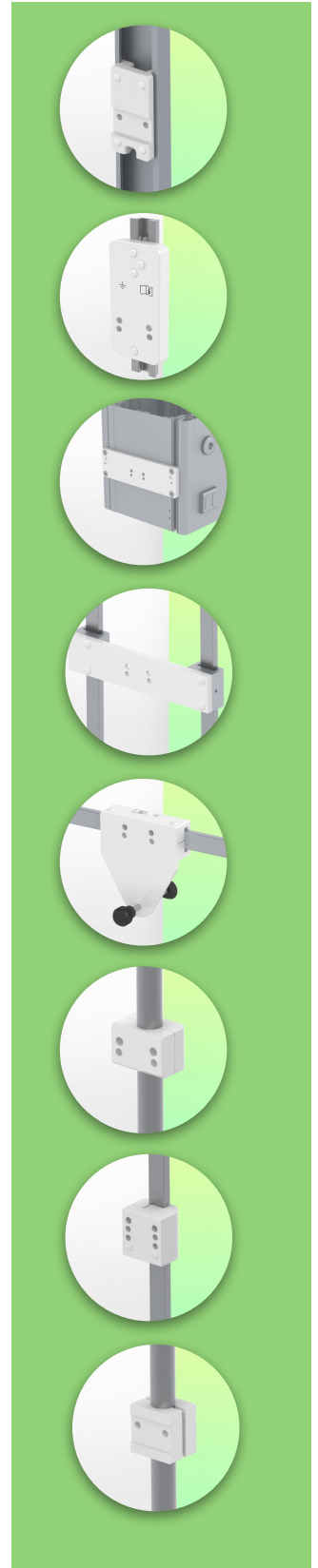



**Keyboard and mouse support options**

**Part Number: WM 335.137**

**300 mm height-adjustable medical arm for keyboard and mouse, for mounting on anaesthesia machines (all manufacturers). Supported weight balance scale from 0 to 4 Kg**

**Compatible accessories for this 300 mm Horizontal arm**

You can complete your installation with these optional accessories:

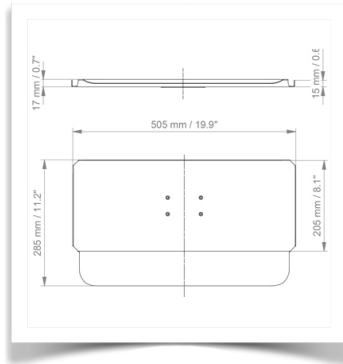

**505 x 205 mm keyboard and mouse stand with wrist rest**

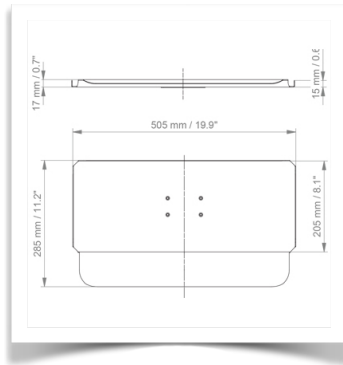

**Keyboard and mouse stand 585 x 205 mm with wrist rest**

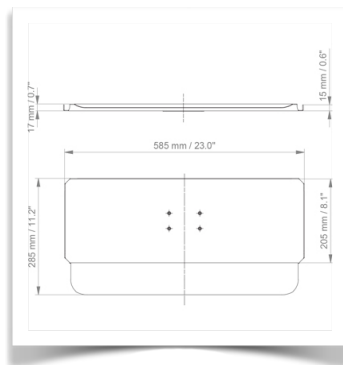

**Keyboard and mouse stand 655 x 205 mm with wrist rest**

