

## Presentation

Part Number: WM 335.143

**300 mm height-adjustable medical double arm for keyboard and mouse, floor or ceiling column mount. Supported weight balance scale from 0 to 4 Kg**



Cette colonne possède deux rails de fixation pour les différents éléments qui y seront fixés. (1 rail à l'avant de la colonne, 1 rail à l'arrière)

This column has two fixing rails for the different elements that will be fixed to it (1 rail at the front of the column, 1 rail at the back)

Deze zuil heeft twee bevestigingsrails voor de verschillende elementen die eraan bevestigd zullen worden (1 rail aan de voorkant van de zuil, 1 rail aan de achterkant)

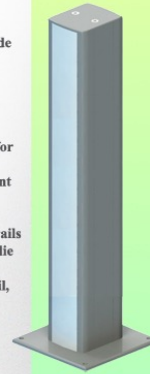

Full cable integration and infection prevention thanks to easy-to-clean surfaces make this arm ideal for emergency care areas. Height adjustment for ergonomic, customised positioning of keyboard and mouse. This 300 mm Horizontal Medical double Arm with gas-lift height adjustment enables the keyboard to be fixed, oriented and adjusted perfectly. It is coated with an anti-microbial agent to ensure hygiene and cleanliness down to the smallest detail. Its modern design has been specially developed for healthcare environments.

### Technical specifications:

- \* Integrated cable passage
- \* Equipotential bonding \* Fixing to the chosen adapter solution (floor or ceiling column mount)
- \* This 300 mm gas strut Horizontal double Arm simply adjusts to the required height and fixed.
- \* It has a safety stop button for height adjustment, which allows the arm to remain in the chosen position.
- \* Arm balance scale 0-4 Kg.
- \* Arm rotation: 90° to the right, 90° to the left from the fixing point.
- \* Height adjustment: 45° down, 45° up
- \* Total length 1002 mm including keyboard support
- \* Standard Mouse Keyboard Support 500 x 200 mm
- \* All our medical arms comply with: CE, ROHS, Medical Grade, Regulations MDD 93/42 ECC
- \* Colour RAL 5013 cobalt blue and RAL 9016 traffic white
- \* Warranty: 5 years

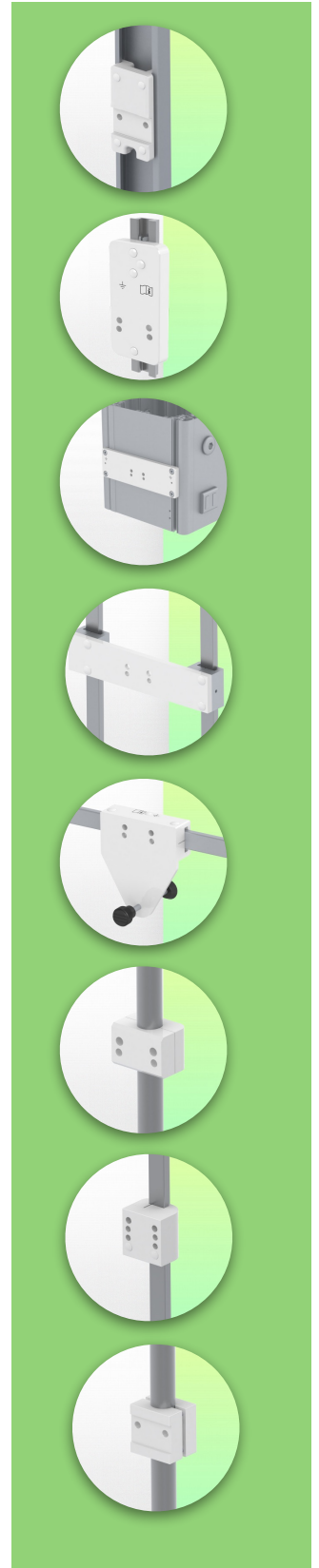

**Technical Specifications**

**Part Number: WM 335.143**

**300 mm height-adjustable medical double arm for keyboard and mouse, floor or ceiling column mount. Supported weight balance scale from 0 to 4 Kg**



Cette colonne possède deux rails de fixation pour les différents éléments qui y seront fixés. (1 rail à l'avant de la colonne, 1 rail à l'arrière)

This column has two fixing rails for the different elements that will be fixed to it (1 rail at the front of the column, 1 rail at the back)

Deze zuil heeft twee bevestigingsrails voor de verschillende elementen die eraan bevestigd zullen worden (1 rail aan de voorkant van de zuil, 1 rail aan de achterkant)

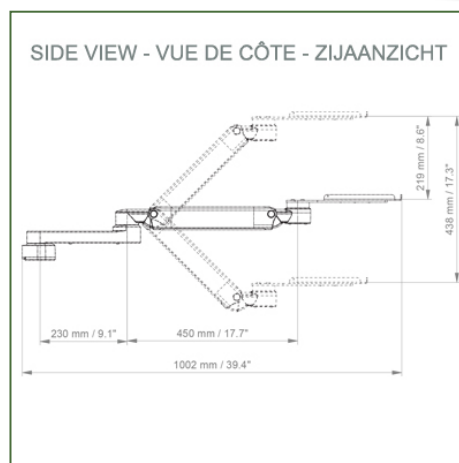
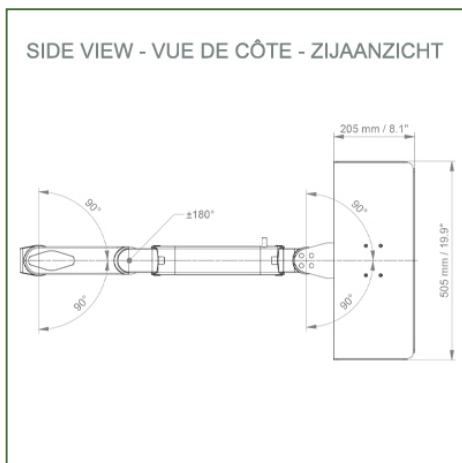
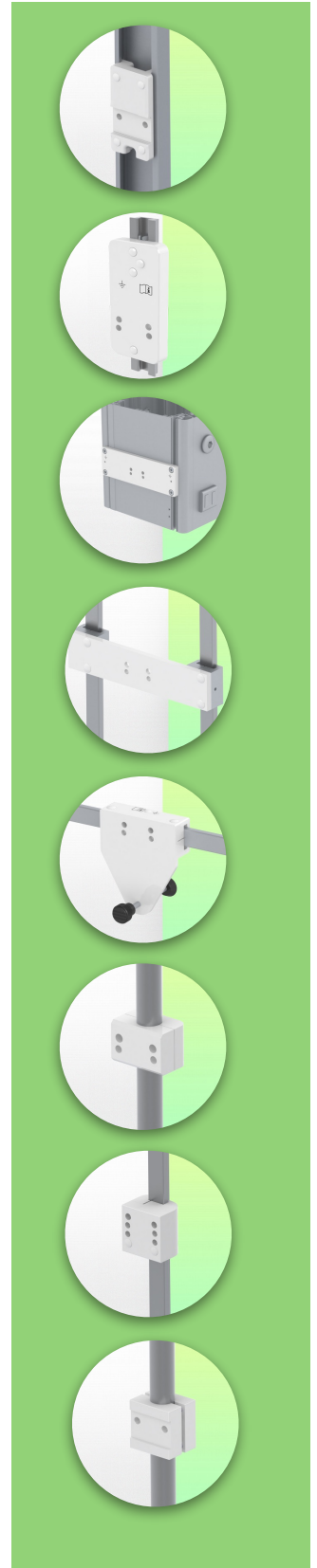
**Balance scale for this medical arm: 0 - 4 Kg Product weight: 5,5 - 7,1 kg / (depending on keyboard tray dimensions)**

**Maximum load capacity of support arm: 20 Kg**

**Height adjustment: parallel mechanism for perfect fit**

**Safety: has a safety stop button for height adjustment, allowing the medical arm to remain in the selected position.**



**Mounting Information - Wall Slide Rail**

**Part Number: WM 335.143**

**300 mm height-adjustable medical double arm for keyboard and mouse, floor or ceiling column mount. Supported weight balance scale from 0 to 4 Kg**

**Floor or ceiling column:**

To install this medical arm, you need to use one of our medical columns. These are available in standard heights of 1500 and 2000 mm. Custom heights are available on request. Slide covers and end caps are supplied with every order.

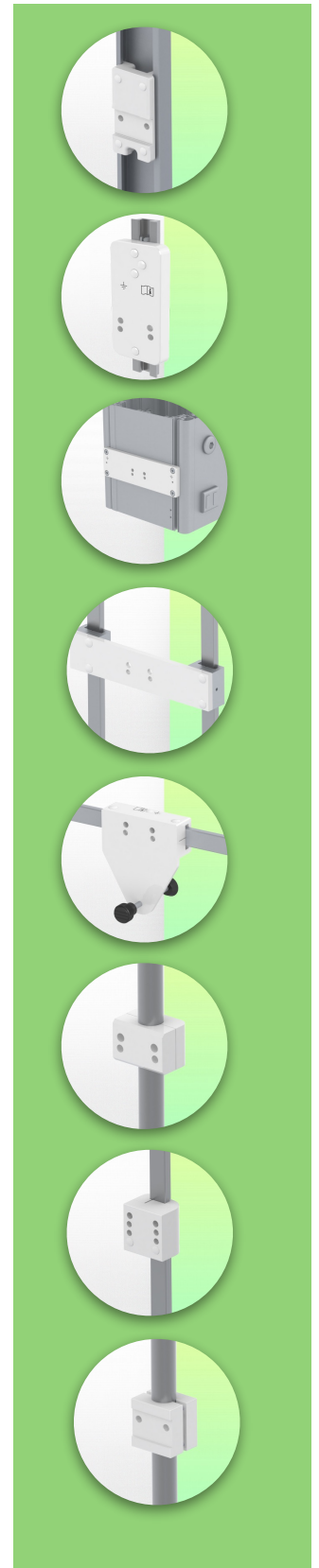
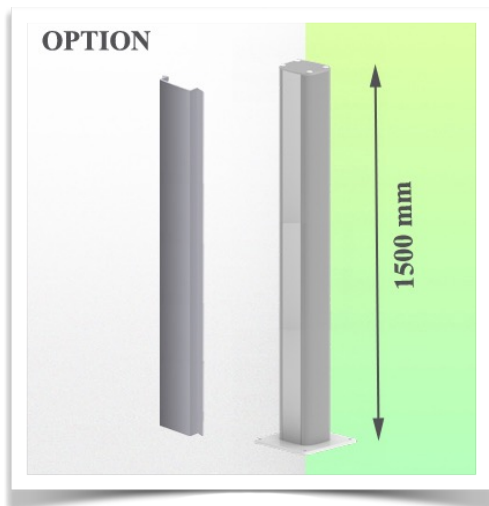

**Mounting information - Mounting options**

**Part Number: WM 335.143**

**300 mm height-adjustable medical double arm for keyboard and mouse, floor or ceiling column mount. Supported weight balance scale from 0 to 4 Kg**

**Where do you want to mount the support arm?**

At the hospital, there are different ways to fix our brackets: round tube, standard rail, wall rail or on an anaesthesia machine. We will always provide you with the adapter you need.



**Adapter for vertical wall slide**  
For wall slide mounting



**Adapter for Amico remote controls and wall panels**



**Adapter for Mindray medical power supply units**

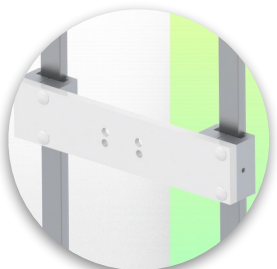

**Double clamp for vertical standard rail**  
For mounting on two parallel vertical standard rails 10 x 25 mm

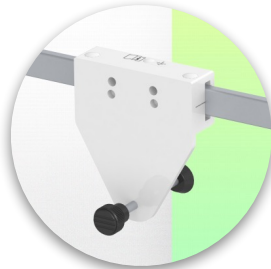

**Fixed clamp for a standard rail**  
For mounting on a horizontal standard rail 10 x 25, 8 x 35, 10 x 30, 10 x 50 mm

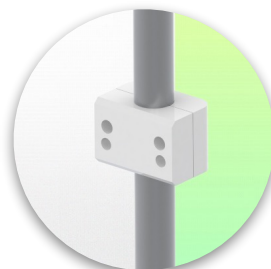

**Fixed clamp for round tube**  
For mounting on round tube  $\varnothing$  25, 35, 38 mm



**Adapter for Maquet anaesthesia machines**  
Cone Adapter for Model FLOW i



**Adapter for Löwenstein anaesthesia machines**  
Medical Adapter for Leon / Leon plus

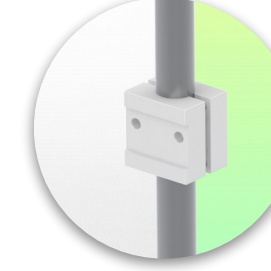

**Universal round tube clamp**  
V-clamp for mounting on round tube  $\varnothing$  23 - 40 mm



**Mounting information - Mounting options**

**Part Number: WM 335.143**

**300 mm height-adjustable medical double arm for keyboard and mouse, floor or ceiling column mount. Supported weight balance scale from 0 to 4 Kg**

**Where do you want to mount the support arm?**

At the hospital, there are different ways to fix our brackets: round tube, standard rail, wall rail or on an anaesthesia machine. We will always provide you with the adapter you need.



**Adapter for anaesthesia machine (all suppliers)**

H 80 mm, with existing side rail

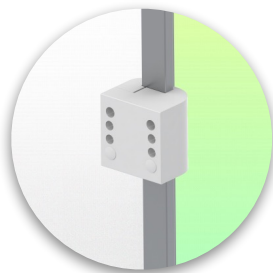

**Clamp for a vertical standard rail**

For mounting on standard rail 10 x 25 mm

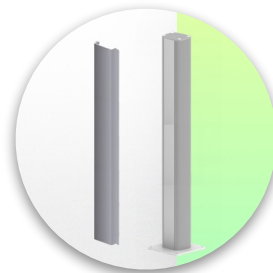

**Floor or ceiling column**  
1500 mm or 2000 mm

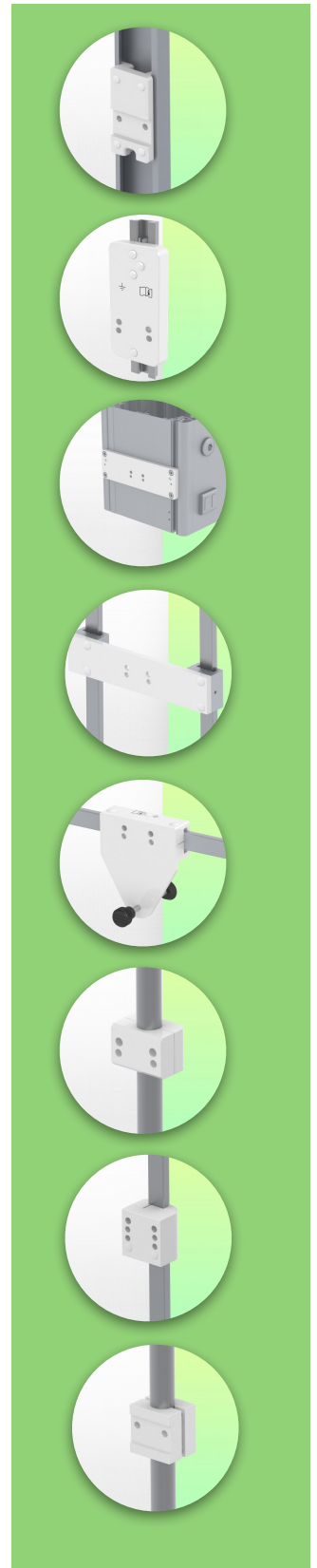

Considered to be the world's best in advanced hygiene control, our medical mounting systems include cable integration, a 5-year maintenance-free warranty and medical grade compliance. We're simply the best in the world at what we do.

**Compatible accessories for this mount**

**Part Part Number: WM**

**300 mm height-adjustable medical double arm for keyboard and mouse, floor or ceiling column mount. Supported weight balance scale from 0 to 4 Kg**

**Compatible accessories for this medical arm**

You can complete your installation with these additional accessories:



**Triple hook for cable** For mounting on support arm



**Double hook for cable** For mounting on support arm



**Downward pole with cable hook** For mounting on support arm



**Double handle with VESA mounting** For VESA monitors



**Handle for VESA monitor support** For VESA monitors



**Double hook for cable** For mounting on a wall or column rail



**Triple hook for cable** For wall or column rail mounting



**Basket** For wall or column rail mounting



**Downward Pole** For mounting on support arm

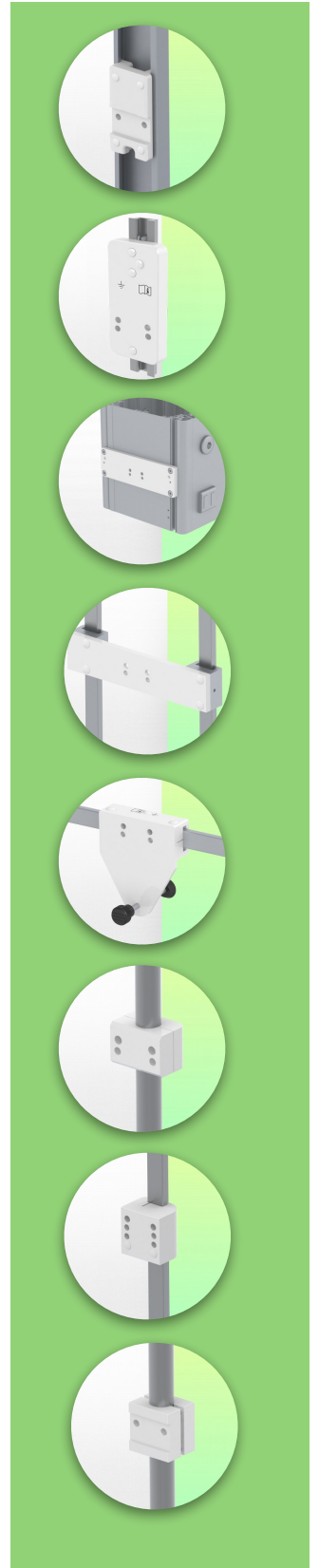

**Keyboard and mouse support options**

**Part Number: WM 335.143**

**300 mm height-adjustable medical double arm for keyboard and mouse, floor or ceiling column mount. Supported weight balance scale from 0 to 4 Kg**

**Compatible accessories for this 300 mm Horizontal arm**

You can complete your installation with these optional accessories:

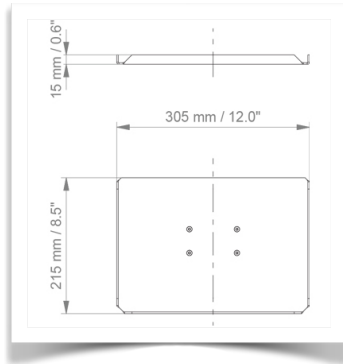

**Keyboard and mouse holder 305 x 215 mm**

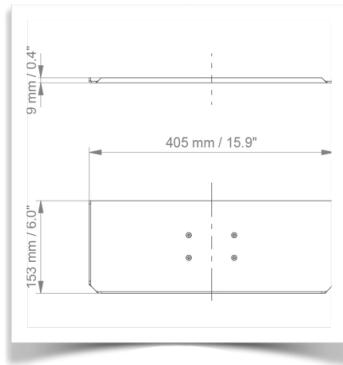

**Keyboard and mouse holder 405 x 153 mm**

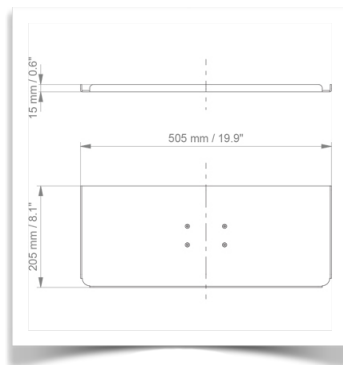

**Keyboard and mouse holder 505 x 205 mm (Supplied as standard)**

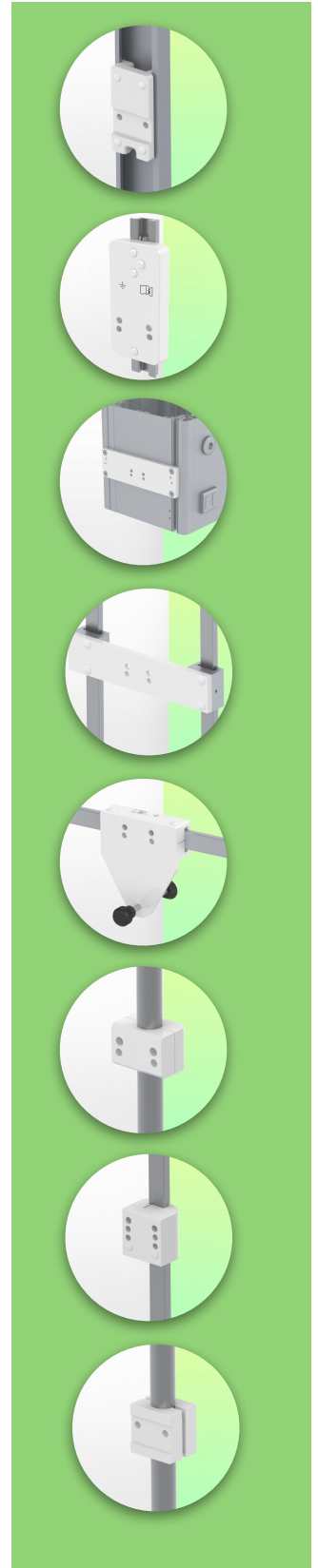

**Keyboard and mouse support options**

**Part Number: WM 335.143**

**300 mm height-adjustable medical double arm for keyboard and mouse, floor or ceiling column mount. Supported weight balance scale from 0 to 4 Kg**

**Compatible accessories for this 300 mm Horizontal arm**

You can complete your installation with these optional accessories:

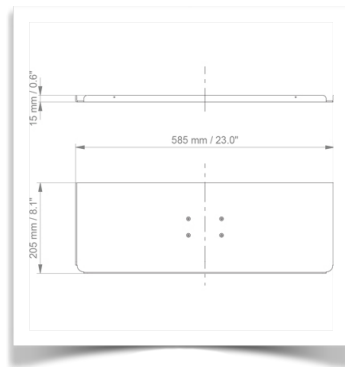

**Keyboard and mouse holder 585 x 205 mm**

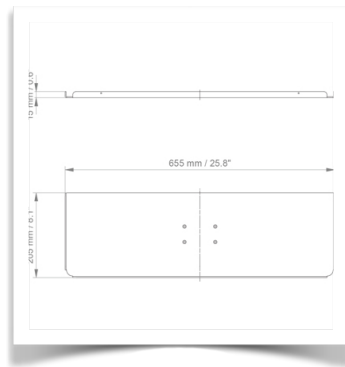

**Keyboard and mouse holder 655 x 205 mm**

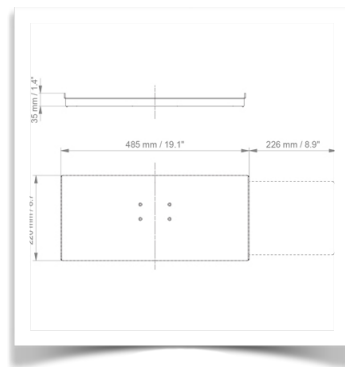

**Sliding keyboard and mouse holder 485 x 220 mm**

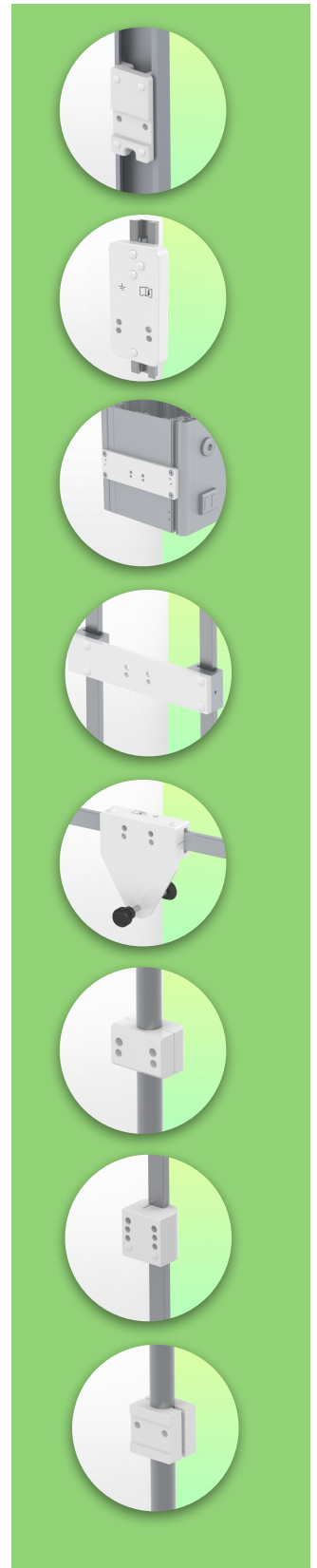



**Keyboard and mouse support options**

**Part Number: WM 335.143**

**300 mm height-adjustable medical double arm for keyboard and mouse, floor or ceiling column mount. Supported weight balance scale from 0 to 4 Kg**

**Compatible accessories for this 300 mm Horizontal arm**

You can complete your installation with these optional accessories:

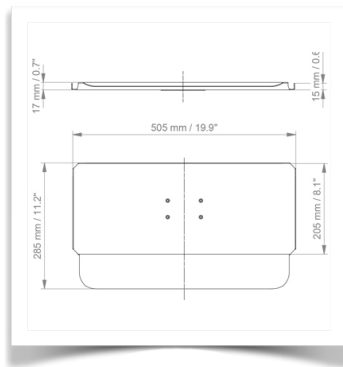

**505 x 205 mm keyboard and mouse stand with wrist rest**

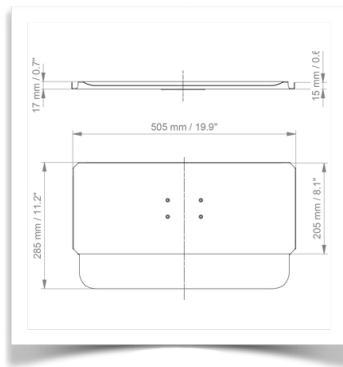

**Keyboard and mouse stand 585 x 205 mm with wrist rest**

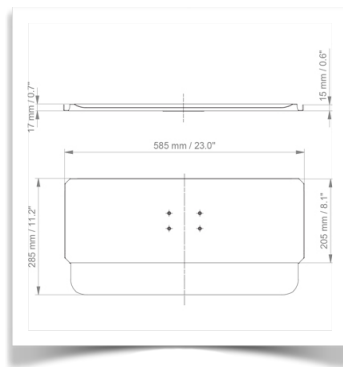

**Keyboard and mouse stand 655 x 205 mm with wrist rest**

