

Presentation

Part Number: WM 336.113

300mm Horizontal Swivel Medical Arm for Laptop, Horizontal Din Rail Mount

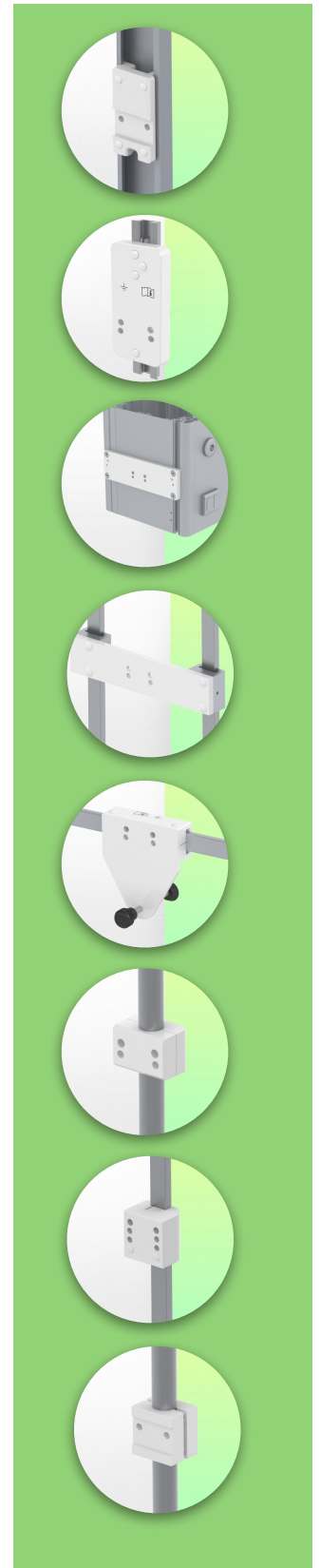
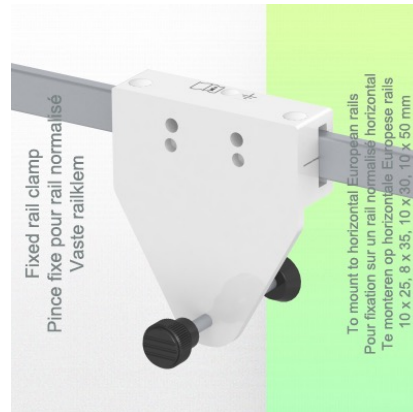
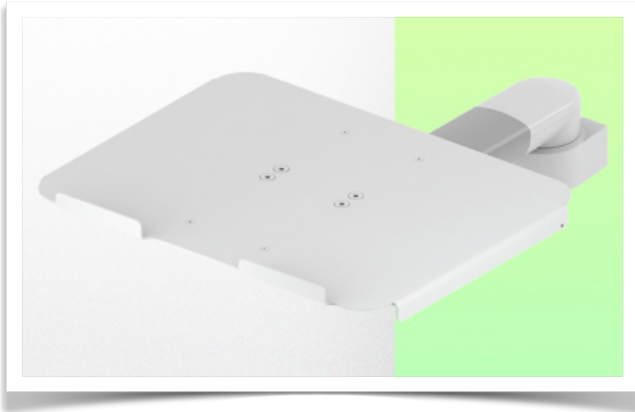

300mm Horizontal Swivel Medical Arm for Laptop, Horizontal Din Rail Mount

This 300 mm swivel medical arm allows you to fix, orient and adjust your laptop perfectly. It is coated with an anti-microbial agent offering hygiene and cleaning in the smallest details. Its modern design has been specially designed for healthcare environments.

Technical specifications:

- * Integrated cable passage
- * Horizontal Din Rail Mounting
- * This 300 mm swivel arm simply attaches to the horizontal rail
- * The laptop support supplied in this version has the dimensions of: 360 x 290 mm
- * The weight supported by the arm is 17 kg and 10 kg for the tray
- * Rotation of the Laptop support: 115° to the right and left, tilt of 20°
- * Rotation of the arm: 105° to the right and left.
- * Total length 502 mm
- * Color RAL 7024 (Graphite gray) and White* All our medical arms are compliant with: CE, ROHS, Medical Grade, MDD 93/42 ECC regulations.
- * Warranty: 5 years

Technical specifications:

Part Number: WM 336.113

300mm Horizontal Swivel Medical Arm for Laptop, Horizontal Din Rail Mount

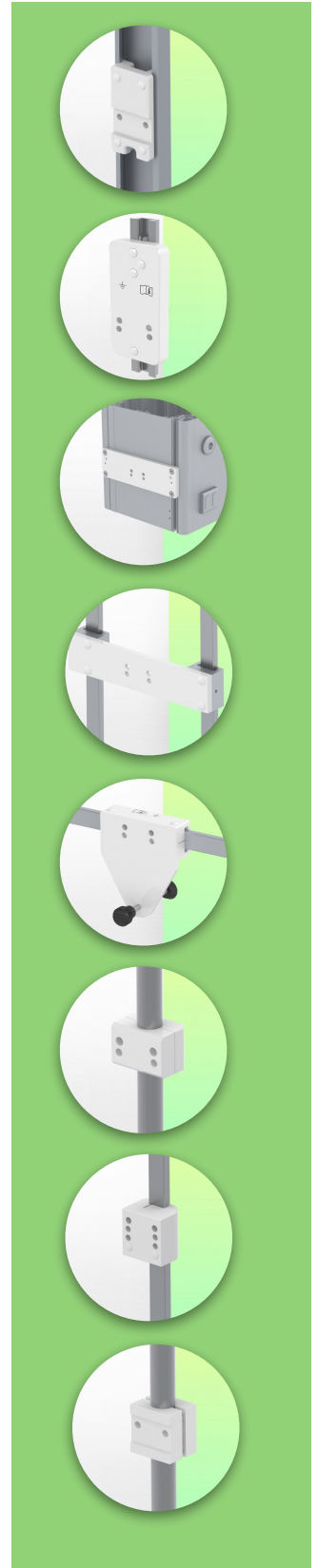
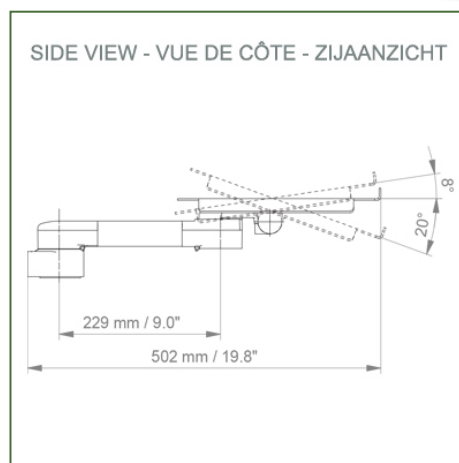
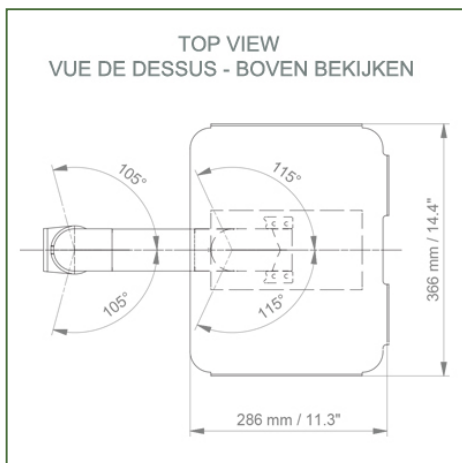
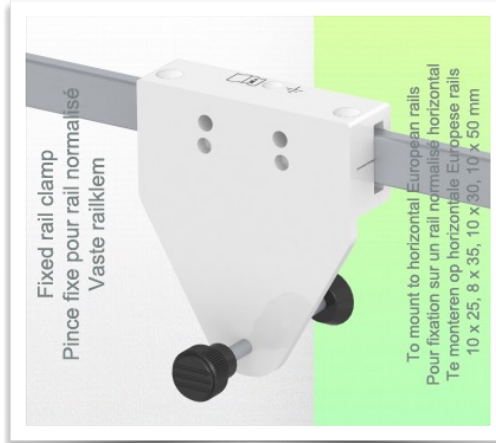
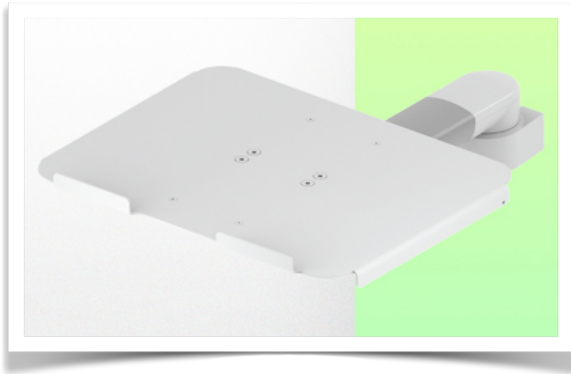

Laptop stand dimensions: 360 x 280 mm

Colour: Decorative parts: RAL 5013 cobalt blue

Aluminium parts: RAL 9016 traffic white

Max. load capacity of the support arm: 17 kg

Load capacity of the tray: 10 kg

Product weight: 2.6 kg

Mounting Information - Din Rail Horizontal

Part Number: WM 336.113

300mm Horizontal Swivel Medical Arm for Laptop, Horizontal Din Rail Mount

Din Rail Horizontal:

Fixed clamp for standard rail For fixing on a horizontal standard rail 10 x 25, 8 x 35, 10 x 30, 10 x 50 mm

