

Presentation

Part Number: WM 336.114

2 x 300mm Horizontal Swivel Medical Arm for Laptop Keyboard, Horizontal Din Rail Mount

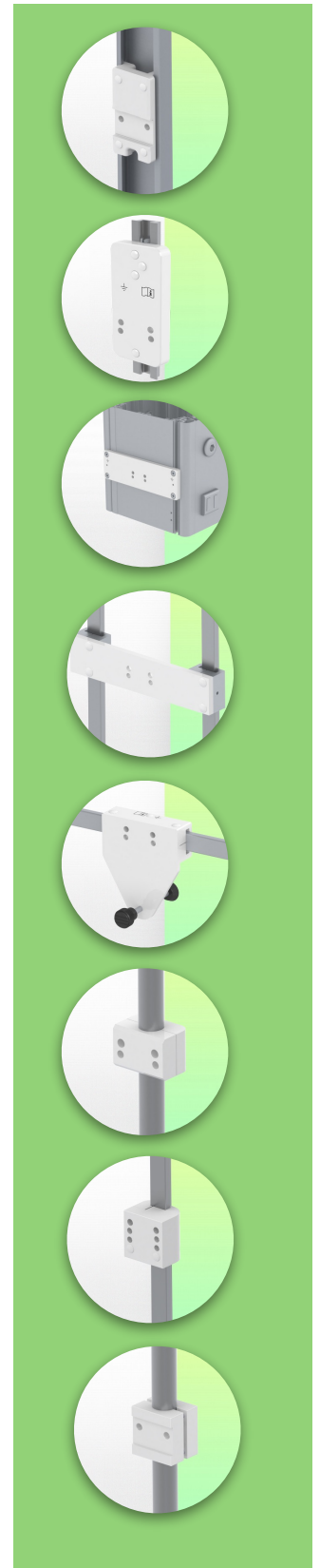
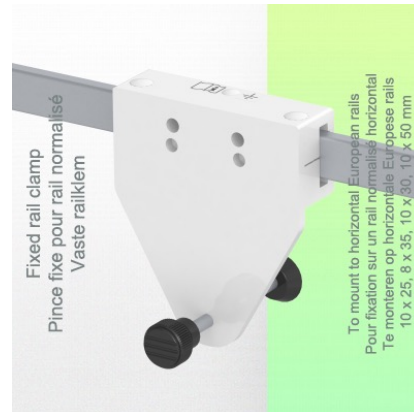
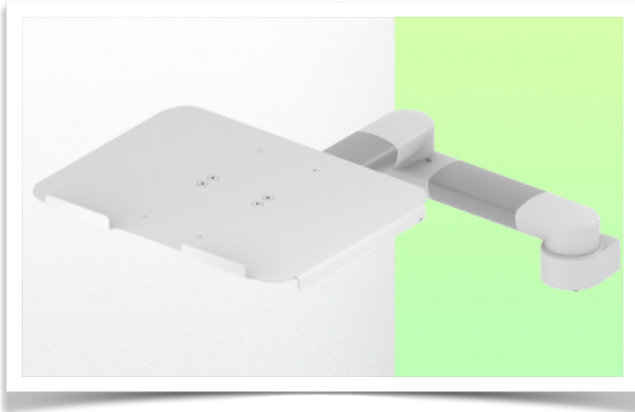

2 x 300mm Horizontal Swivel Medical Arm for Laptop Keyboard, Horizontal Din Rail Mount

This 2 x 300 mm double swivel medical arm allows you to perfectly fix, orient and adjust your laptop. It is coated with an anti-microbial agent offering hygiene and cleaning down to the smallest details. Its modern design has been specially designed for healthcare environments.

Technical specifications:

- * Integrated cable passage
- * Horizontal Din Rail Mounting
- * This 2 x 300 mm swivel arm simply attaches to the horizontal rail
- * The laptop support supplied in this version has the dimensions of: 360 x 290 mm
- * The weight supported by the arm is 7 kg and 7 kg for the tray
- * Rotation of the Laptop support: 115° to the right and left, tilt of 20°
- * Rotation of the arm: 105° to the right and left, and 165° at the intersection
- * Total length 731 mm
- * Color RAL 7024 (Graphite gray) and White
- * All our medical arms are compliant with: CE, ROHS, Medical Grade, MDD 93/42 ECC regulations.
- * Warranty: 5 years

Technical specifications:

Part Number: WM 336.114

2 x 300mm Horizontal Swivel Medical Arm for Laptop Keyboard, Horizontal Din Rail Mount

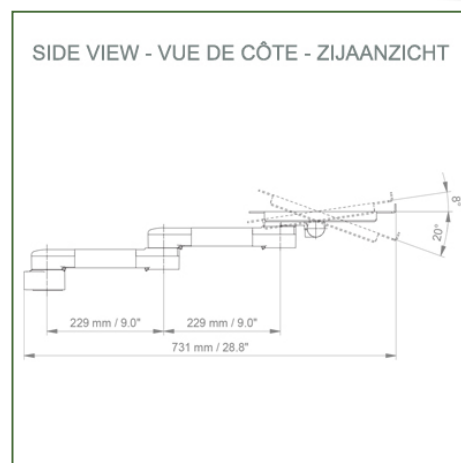
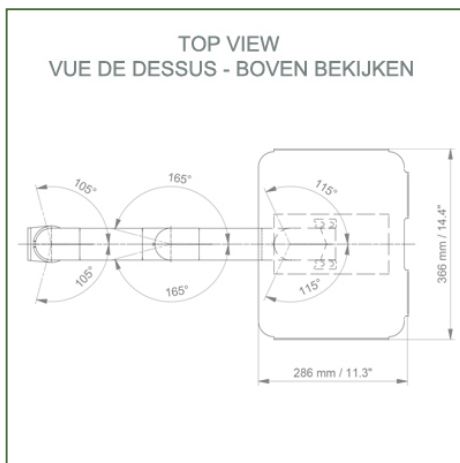
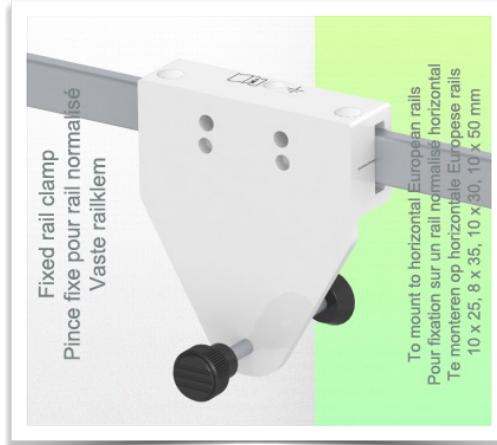
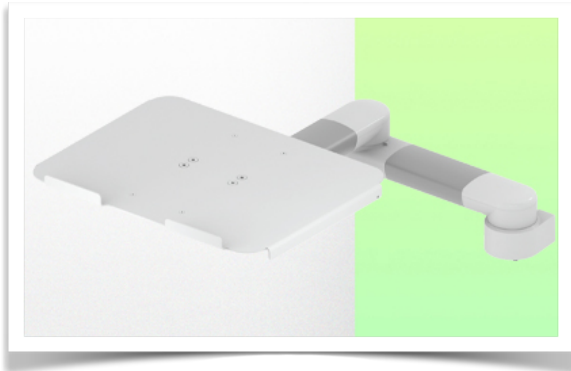

Laptop stand dimensions: 360 x 280 mm

Colour: Decorative parts: RAL 5013 cobalt blue

Aluminium parts: RAL 9016 traffic white

Max. load capacity of the support arm: 7 kg

Load capacity of the tray: 7 Kg

Product weight: 3.6 Kg

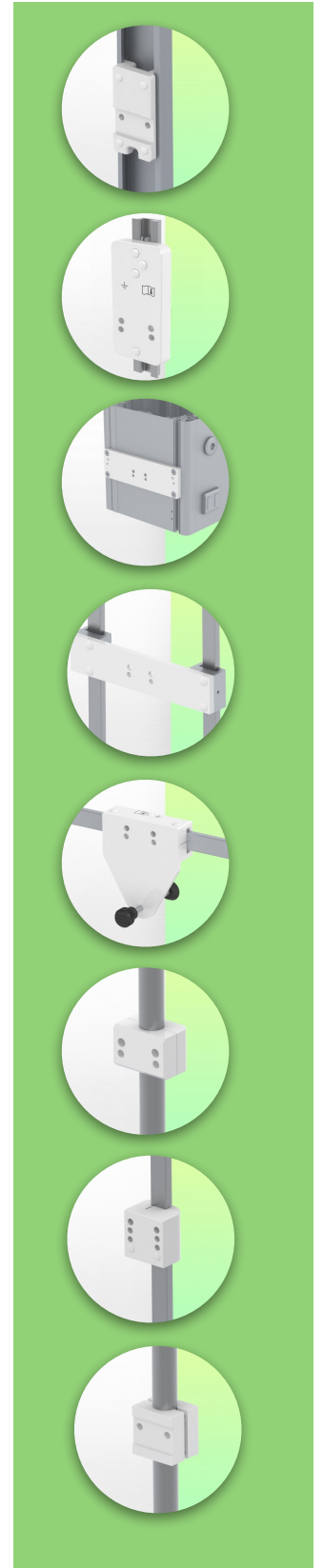

Mounting Information - Din Rail Horizontal

Part Number: WM 336.114

2 x 300mm Horizontal Swivel Medical Arm for Laptop Keyboard, Horizontal Din Rail Mount

Din Rail Horizontal:

Fixed clamp for standard rail For fixing on a horizontal standard rail 10 x 25, 8 x 35, 10 x 30, 10 x 50 mm

