

Presentation

Part Number: WM 336.115

300mm Swivel Horizontal Medical Arm for Laptop, Vertical Din Rail Mount

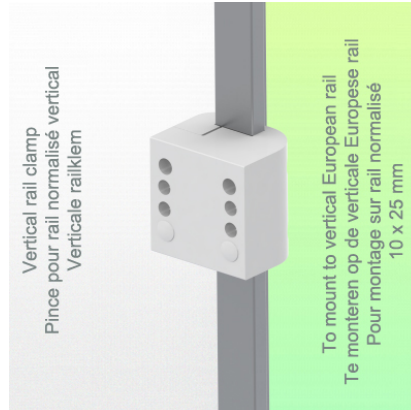
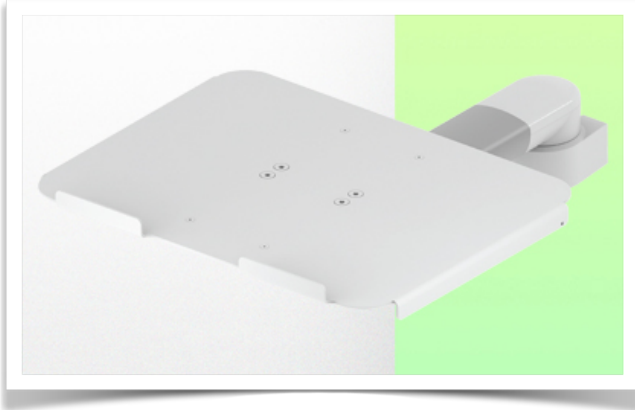

300mm Swivel Horizontal Medical Arm for Laptop, Vertical Din Rail Mount

This 300 mm swivel medical arm allows you to fix, orient and adjust your laptop perfectly. It is coated with an anti-microbial agent offering hygiene and cleaning in the smallest details. Its modern design has been specially designed for healthcare environments.

Technical specifications:

- * Vertical Din Rail Mounting
- * This 300 mm swivel arm simply attaches to the vertical rail
- * The laptop stand supplied in this version has the dimensions of: 360 x 290 mm
- * The weight supported by the arm is 17 kg and 10 kg for the tray
- * Rotation of the Laptop stand: 115° to the right and left, 20° tilt
- * Rotation of the arm: 105° to the right and left.
- * Total length 502 mm
- * Color RAL 7024 (Graphite gray) and White
- * All our medical arms are compliant with: CE, ROHS, Medical Grade, MDD 93/42 ECC regulations.
- * Warranty: 5 years

Technical specifications:

Part Number: WM 336.115

300mm Swivel Horizontal Medical Arm for Laptop, Vertical Din Rail Mount

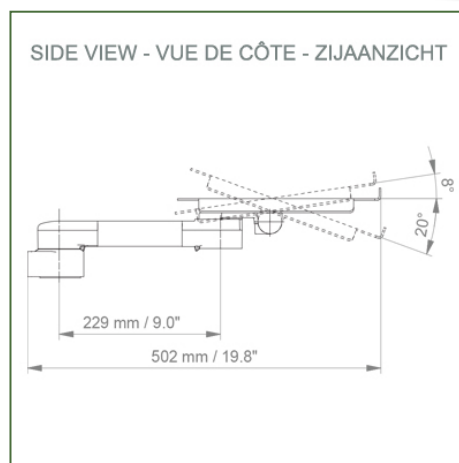
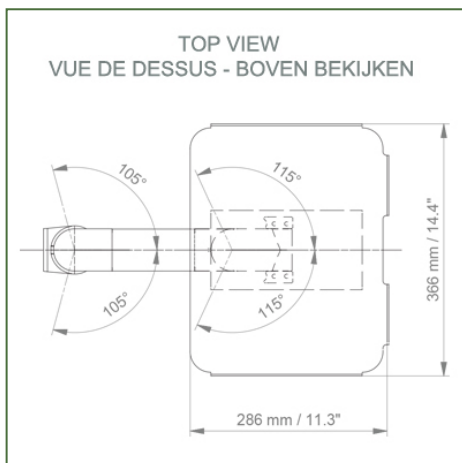
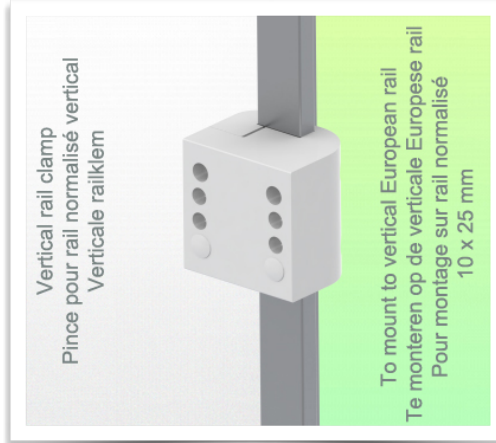
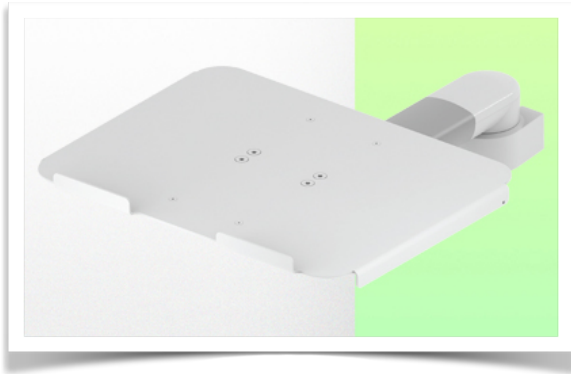

Laptop stand dimensions: 360 x 280 mm

Colour: Decorative parts: RAL 5013 cobalt blue

Aluminium parts: RAL 9016 traffic white

Max. load capacity of the support arm: 17 kg

Load capacity of the tray: 10 kg

Product weight: 2.6 kg

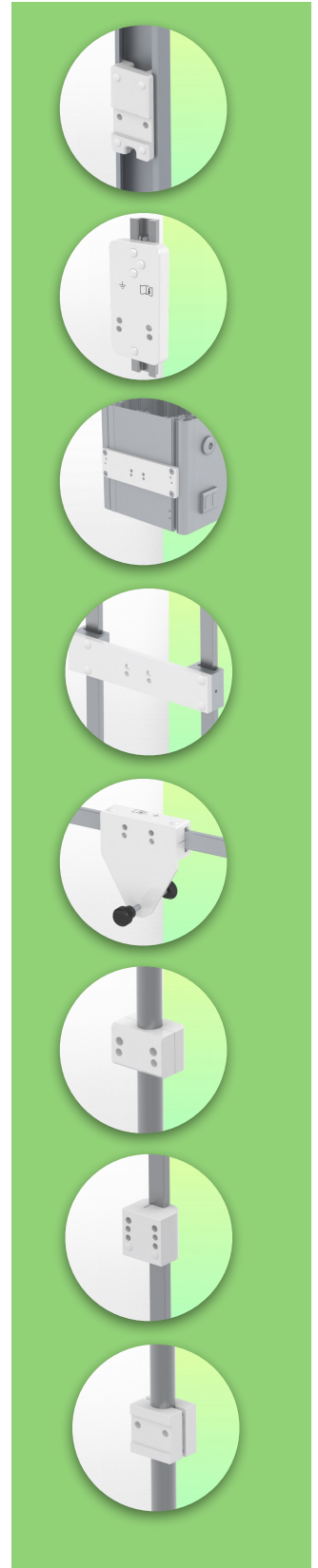

Mounting Information - Din Rail Vertical

Part Number: WM 336.115

300mm Swivel Horizontal Medical Arm for Laptop, Vertical Din Rail Mount

Din Rail Vertical:

Fixed clamp for standard rail For fixing on a standard rail Vertical 10 x 25, 8 x 35, 10 x 30, 10 x 50 mm

