

Presentation

Part Number: WM 336.119

**300mm Swivel Horizontal Medical Arm for Laptop,
Variable Pole Mount 23 - 40mm**

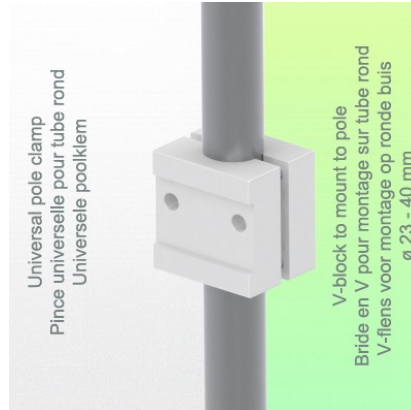
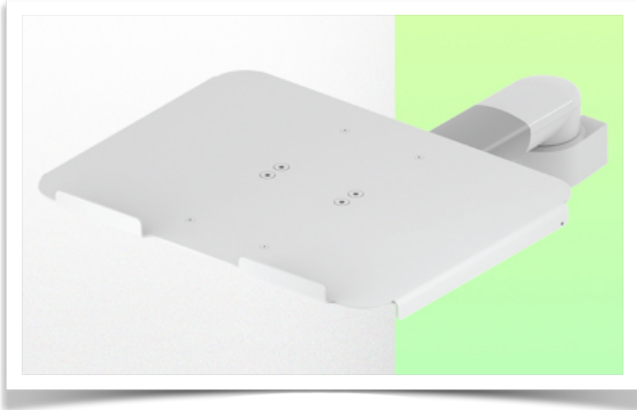

**300mm Swivel Horizontal Medical Arm for Laptop,
Variable Pole Mount 23 - 40mm**

This 300 mm swivel medical arm allows you to fix, orient and adjust your laptop perfectly. It is coated with an anti-microbial agent offering hygiene and cleaning in the smallest details. Its modern design has been specially designed for healthcare environments.

Technical specifications:

- * Variable pole attachment from 23 to 40 mm
- * This 300 mm swivel arm simply attaches to the pole
- * The laptop stand supplied in this version has the dimensions of: 360 x 290 mm
- * The weight supported by the arm is 17 kg and 10 kg for the tray
- * Rotation of the Laptop stand: 115° to the right and left, tilt of 20°
- * Rotation of the arm: 105° to the right and left.
- * Total length 502 mm
- * Color RAL 7024 (Graphite gray) and White
- * All our medical arms are compliant with: CE, ROHS, Medical Grade, MDD 93/42 ECC regulations.
- * Warranty: 5 years

Technical specifications:

Part Number: WM 336.119

**300mm Swivel Horizontal Medical Arm for Laptop,
Variable Pole Mount 23 - 40mm**

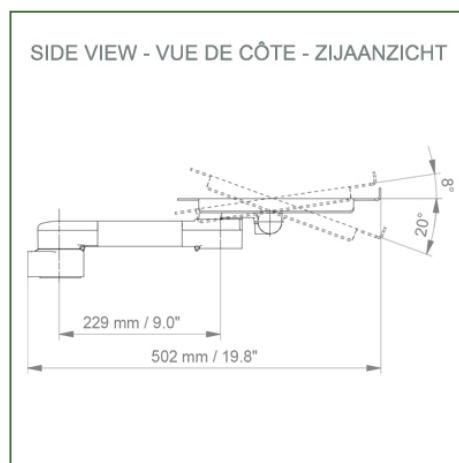
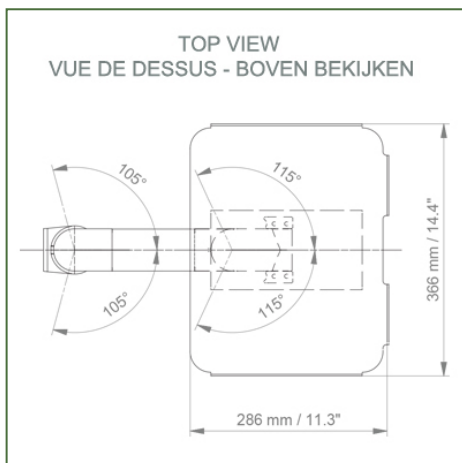
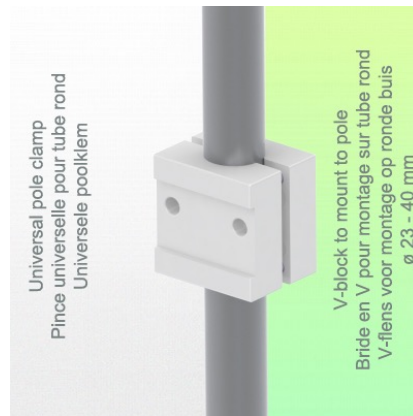
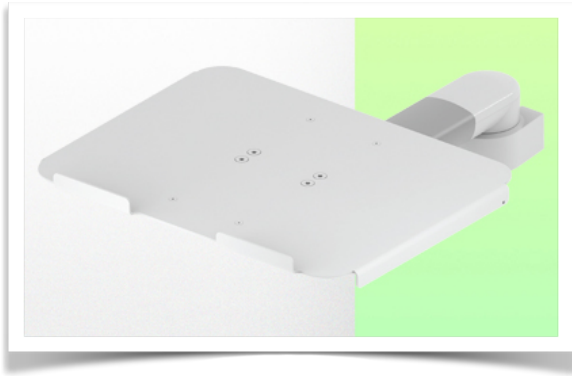

Laptop stand dimensions: 360 x 280 mm

Colour: Decorative parts: RAL 5013 cobalt blue

Aluminium parts: RAL 9016 traffic white Max.

load capacity of the support arm: 17 kg

Load capacity of the tray: 10 kg

Product weight: 2.6 kg

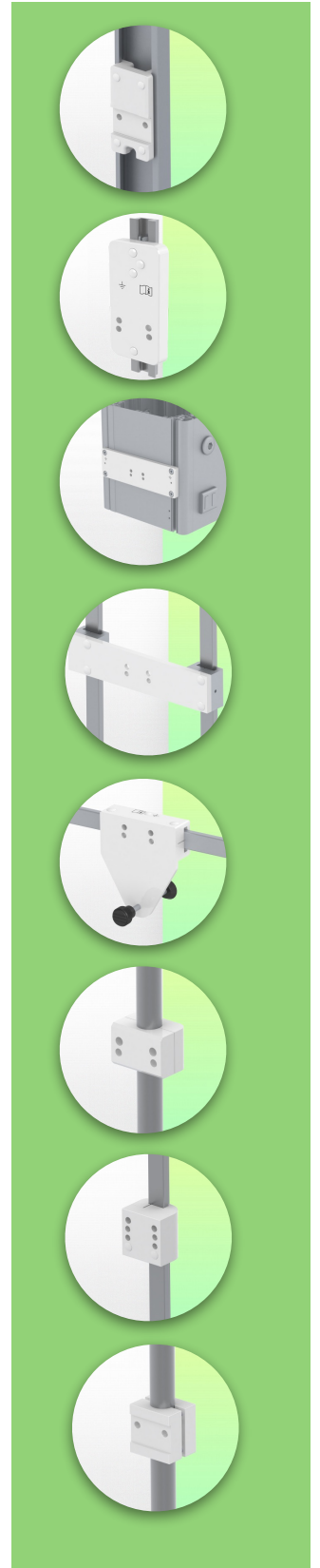

Assembly Information - Pole Variable

Part Number: WM 336.119

**300mm Swivel Horizontal Medical Arm for Laptop,
Variable Pole Mount 23 - 40mm**

Pole variable:

For fixing mounting of round tube with diameter from 23 to 40 mm

