

Présentation

Part Number: WM 336.120

**2 x 300 mm Horizontal Swivel Medical Laptop Arm,
Variable Pole Mount 23 - 40mm**

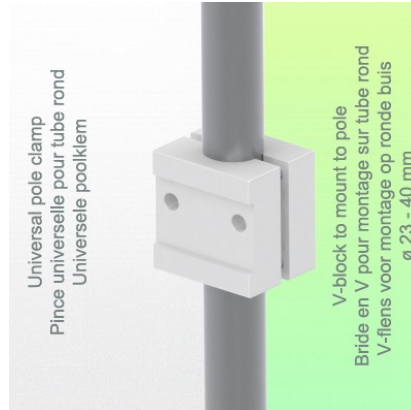
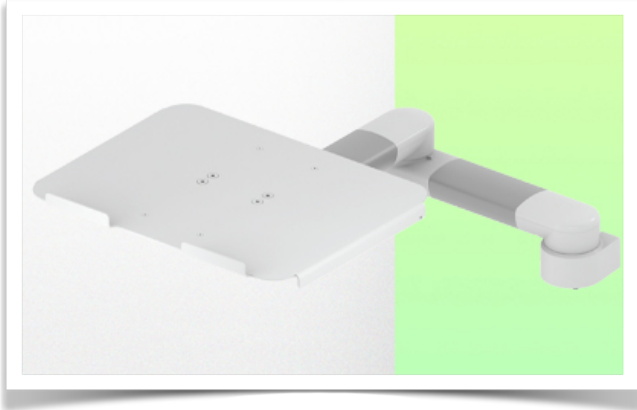

**2 x 300 mm Horizontal Swivel Medical Laptop Arm,
Variable Pole Mount 23 - 40mm**

This 2 x 300 mm double swivel medical arm allows you to perfectly fix, orient and adjust your laptop. It is coated with an anti-microbial agent offering hygiene and cleaning down to the smallest details. Its modern design has been specially designed for healthcare environments.

Technical specifications:

- * Integrated cable passage
- * Variable pole attachment from 2.3 to 40 mm
- * This 300 mm swivel arm simply attaches to the pole
- * The laptop support supplied in this version has the dimensions of: 360 x 290 mm
- * The weight supported by the arm is 7 kg and 7 kg for the tray
- * Rotation of the Laptop support: 115° to the right and left, tilt of 20°
- * Rotation of the arm: 105° to the right and left, and 165° at the intersection
- * Total length 731 mm
- * Color RAL 7024 (Graphite gray) and White
- * All our medical arms are compliant with: CE, ROHS, Medical Grade, MDD 93/42 ECC regulations.
- * Warranty: 5 years

Technical specifications:

Part Number: WM 336.120

2 x 300 mm Horizontal Swivel Medical Laptop Arm,
Variable Pole Mount 23 - 40mm

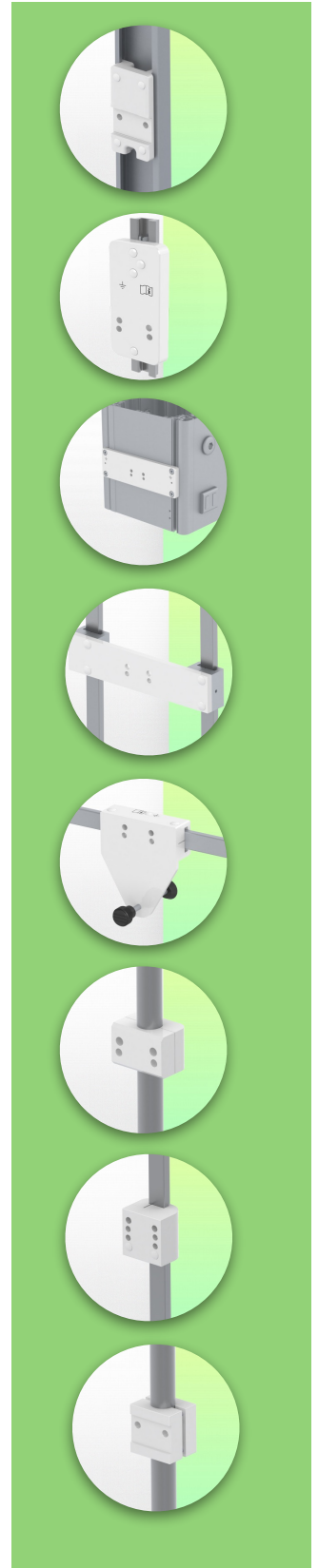
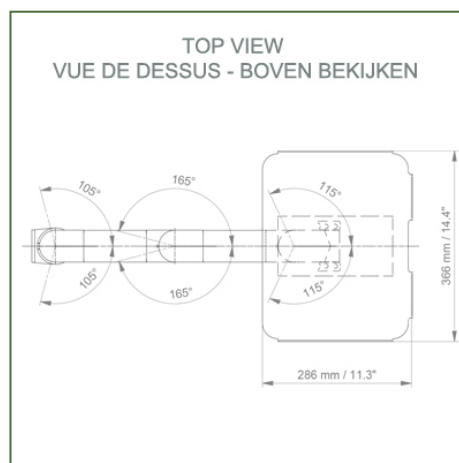
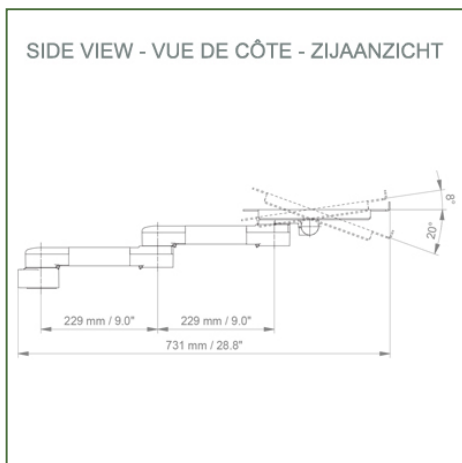
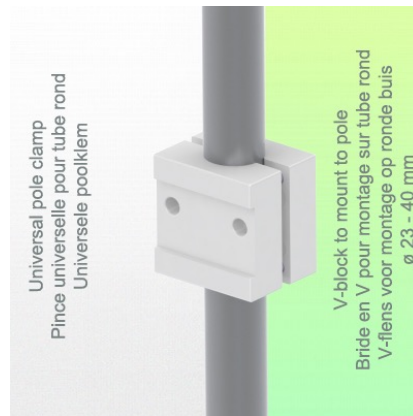
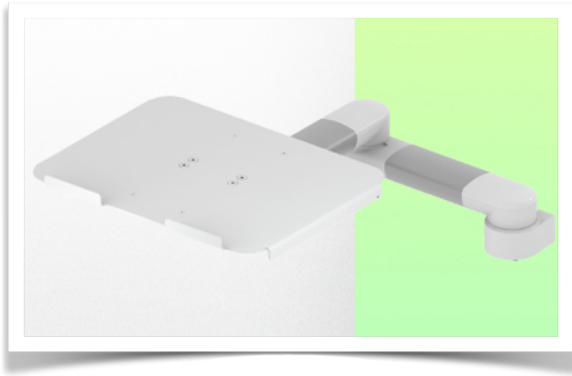

Laptop stand dimensions: 360 x 280 mm

Colour: Decorative parts: RAL 5013 cobalt blue

Aluminium parts: RAL 9016 traffic white Max.

load capacity of the support arm: 7 kg

Load capacity of the tray: 7 Kg

Product weight: 3.6 Kg

Assembly Information - Pole Variable

Part Number: WM 336.120

**2 x 300 mm Horizontal Swivel Medical Laptop Arm,
Variable Pole Mount 23 - 40mm**

Pole variable:

For fixing mounting of round tube with diameter from 23 to 40 mm

