

Presentation

Part Number: WM 336.125

**300 mm Horizontal Medical Arm for Laptop, Mounting on Anaesthesia Machines
(All Manufacturers)**

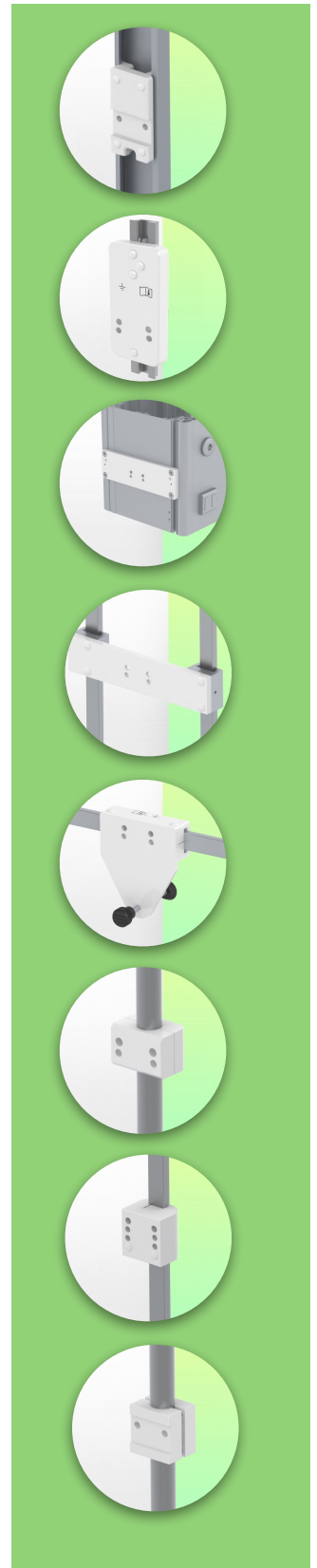
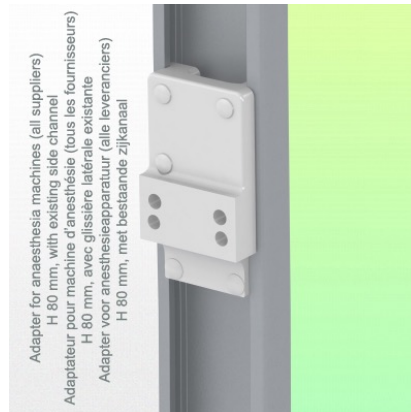
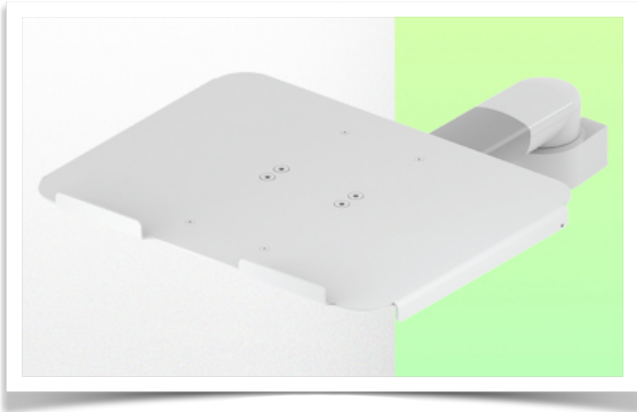

300 mm Horizontal Medical Arm for Laptop, Mounting on Anaesthesia Machines (All Manufacturers)

This 300 mm swivel medical arm allows you to fix, orientate and adjust your laptop perfectly. It is coated with an anti-microbial agent to ensure hygiene and cleanliness down to the smallest detail.

Its modern design has been specially developed for healthcare environments.

Technical specifications:

- * Integrated cable management
- * Attachment to anaesthesia machine (all manufacturers)
- * This 300 mm swivel arm simply slides into the machine's existing rail.
- * The laptop holder supplied in this version has the following dimensions 360 x 290 mm
- * The weight of the arm is 17 kg and 10 kg for the tray
- * Laptop support rotation: 115° right and left, 20° tilt
- * Arm rotation: 105° right and left.
- * Total length 502 mm * Colour RAL 7024 (Graphite Grey) and White
- * All our medical arms are CE, ROHS, Medical Grade, MDD 93/42 ECC compliant.
- * Warranty: 5 years

Technical specifications:

Part Number: WM 336.125

**300 mm Horizontal Medical Arm for Laptop, Mounting on Anaesthesia Machines
(All Manufacturers)**

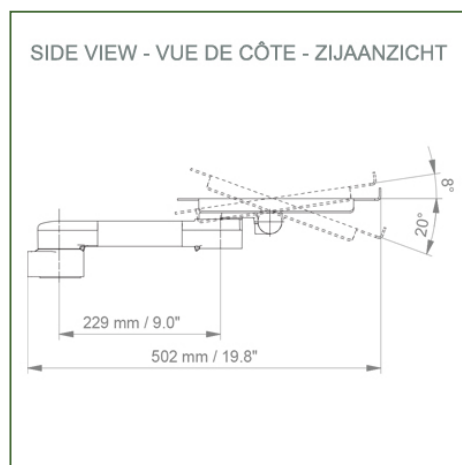
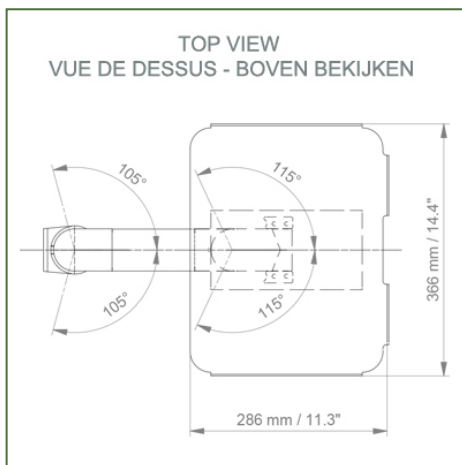
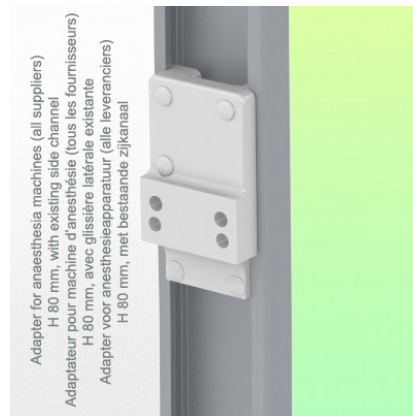
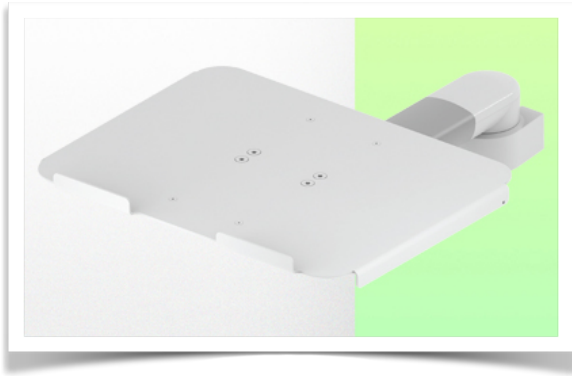

Laptop stand dimensions: 360 x 280 mm

Colour: Decorative parts: RAL 5013 cobalt blue

Aluminium parts: RAL 9016 traffic white

Max. load capacity of support arm: 17 kg

Tray load capacity: 10 Kg

Product weight: 2,6 Kg

Mounting information - Anesthesia rail adapter

Part Number: WM 336.125

**300 mm Horizontal Medical Arm for Laptop, Mounting on Anaesthesia Machines
(All Manufacturers)**

Anesthesia rail adapter:

Mounting on anaesthesia machines (All manufacturers)

Mount on the existing rail of the anaesthesia machine with this adapter

