

**Presentation**

**Part Number: WM 336.127**

**300mm Swivel Horizontal Medical Arm for Laptop,  
Table Column Mount**

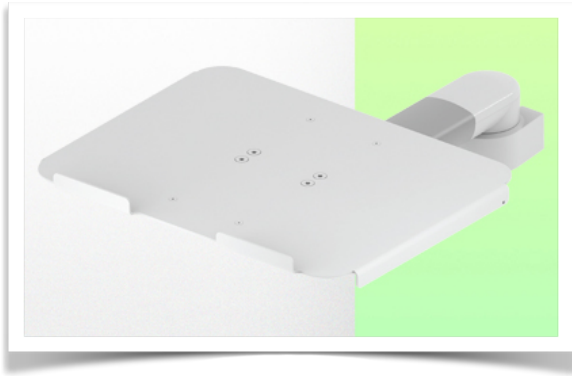

Cette colonne possède deux rails de fixation pour les différents éléments qui y seront fixés.  
1 rail à l'avant de la colonne,  
1 rail à l'arrière

Deze kolom heeft twee bevestigings rails voor de verschillende elementen die eraan zullen worden bevestigd.  
1 rail aan de voorkant van de kolom,  
1 rail aan de achterkant

This column has two fixing rails for the various elements that will be fixed to it. 1 rail at the front of the column, 1 rail at the back)

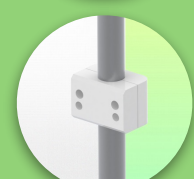
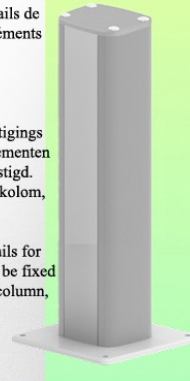

**300mm Swivel Horizontal Medical Arm for Laptop,  
Table Column Mount**

This 300 mm swivel medical arm allows you to fix, orient and adjust your laptop perfectly. It is coated with an anti-microbial agent offering hygiene and cleaning in the smallest details. Its modern design has been specially designed for healthcare environments.

**Technical specifications:**

- \* Table column attachment
- \* This 300 mm swivel arm simply attaches to the table column
- \* The laptop stand supplied in this version has the dimensions of: 360 x 290 mm
- \* The weight supported by the arm is 17 kg and 10 kg for the tray
- \* Laptop support rotation: 115° right and left, 20° tilt
- \* Arm rotation: 105° right and left.
- \* Total length 502 mm
- \* Colour RAL 7024 (Graphite grey) and White
- \* All our medical arms are compliant with: CE, ROHS, Medical Grade, MDD 93/42 ECC regulations.
- \* Warranty: 5 years

**Technical specifications:**

**Part Number: WM 336.127**

**300mm Swivel Horizontal Medical Arm for Laptop,  
Table Column Mount**

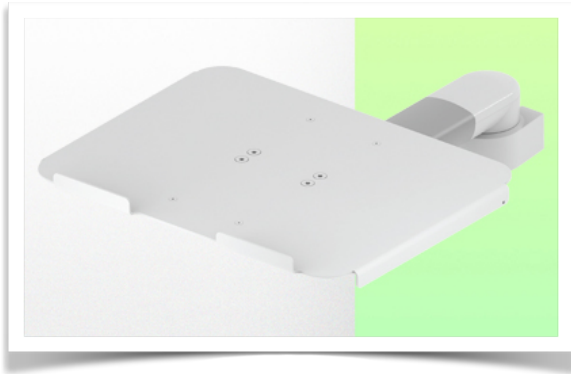

Cette colonne possède deux rails de fixation pour les différents éléments qui y seront fixés.

1 rail à l'avant de la colonne,  
1 rail à l'arrière

Deze kolom heeft twee bevestigings rails voor de verschillende elementen die eraan zullen worden bevestigd.

1 rail aan de voorkant van de kolom,  
1 rail aan de achterkant

This column has two fixing rails for the various elements that will be fixed to it. 1 rail at the front of the column, 1 rail at the back)

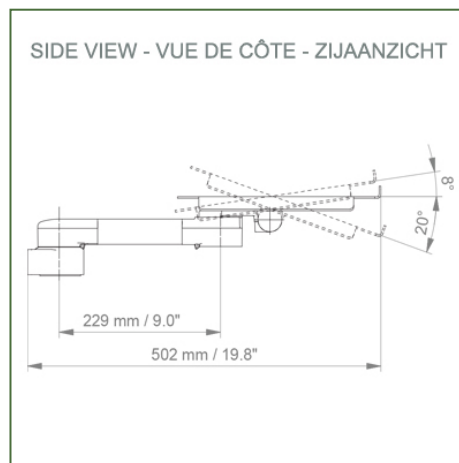
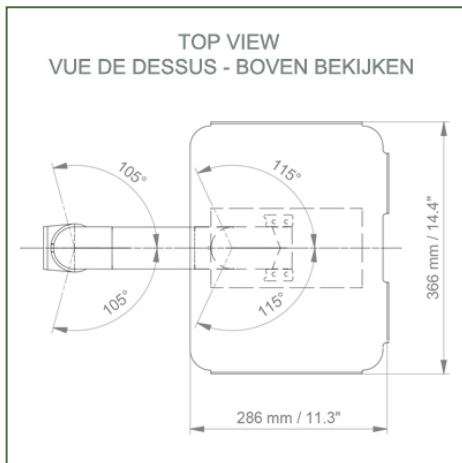
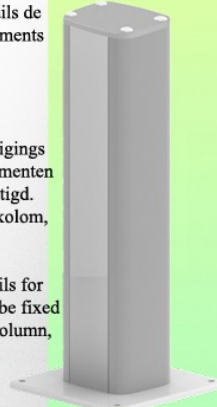

**Laptop stand dimensions: 360 x 280 mm**

**Colour: Decorative parts: RAL 5013 cobalt blue**

**Aluminium parts: RAL 9016 traffic white**

**Max. load capacity of the support arm: 17 kg**

**Load capacity of the tray: 10 kg**

**Product weight: 2.6 kg**

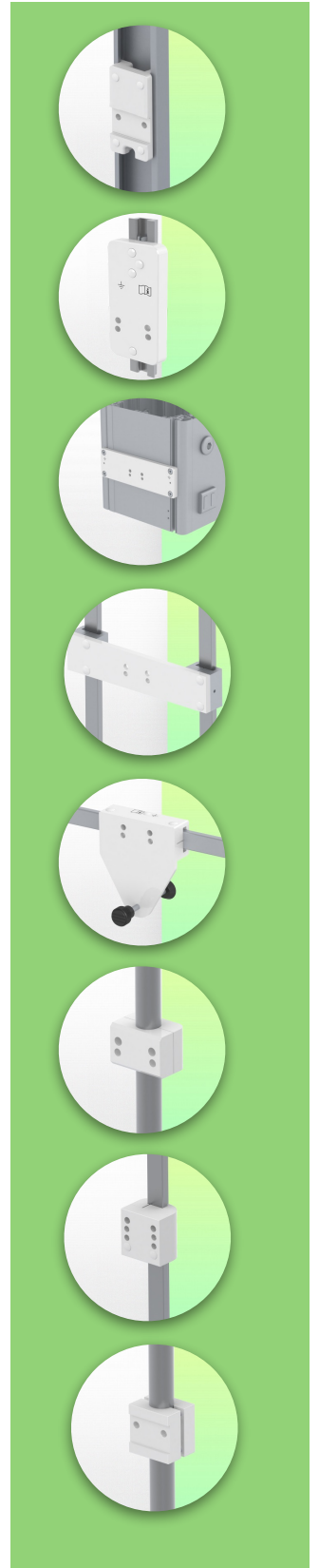

**Assembly information - Table column rail**

**Part Number: WM 336.127**

**300mm Swivel Horizontal Medical Arm for Laptop,  
Table Column Mount**

**Table column:**

To install this medical arm you must use one of our medical columns. These are available in standard heights of 500 and 300 mm. Custom heights are available on request. Slide covers and end caps are supplied with each order.

