

Presentation

Part Number: WM 996.117

500 mm medical column with arm for two horizontal screens side by side

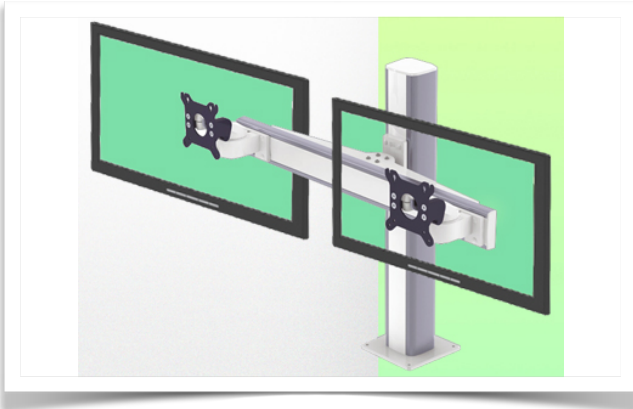

Cette colonne possède deux rails de fixation pour les différents éléments qui y seront fixés.
1 rail à l'avant de la colonne,
1 rail à l'arrière

Deze kolom heeft twee bevestigings rails voor de verschillende elementen die eraan zullen worden bevestigd.
1 rail aan de voorkant van de kolom,
1 rail aan de achterkant

This column has two fixing rails for the various elements that will be fixed to it. (1 rail at the front of the column, 1 rail at the back)

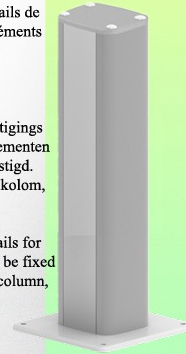

500 mm medical column with arm for two horizontal screens side by side

This 500 mm medical column allows two screens to be perfectly fixed, oriented and adjusted side by side.

The entire unit is coated with an anti-microbial agent to ensure hygiene and cleaning in every detail.

Its modern design has been specially developed for healthcare environments.

Technical specifications:

- * Integrated cable management
- * This column can be easily cut to size.
- * All cables are routed through the column, the horizontal rail and the mini arms.
All cables run through the column, the horizontal rail and the mini arms.
No cables are visible.
Two cable covers are supplied with this configuration.
- The column has a front and a back panel to allow the addition of other elements, these simply slide into the column
simply slide into the column and then adjust to the desired height and and fixed.
(see our medical accessories)
- * The heads of the 2 mini arms, are in conformity with the standard of mounting of the VESA MIS-D 75 mm and 100 mm. Rotating tilt head.
- * Compatible with screens weighing up to 16 kg.
- * Stability of the touch screen.
- * Screen tilt: 30° down and 17° up
- * Screen rotation: 60°/90° right, 90°/60° left.
- * Horizontal arm rotation: 95° right, 95° left.
- * Horizontal arm length: 728 mm (Please check the dimensions of your screens)
- * Column height: 500 mm
- * Compatible with Multimedia Terminals (TMM)
- * Colour RAL 7024 (Graphite Grey) and White
- * All our medical arms are in compliance with :
CE, ROHS, Medical Grade, Regulations MDD 93/42 ECC.
- * Warranty: 5 years

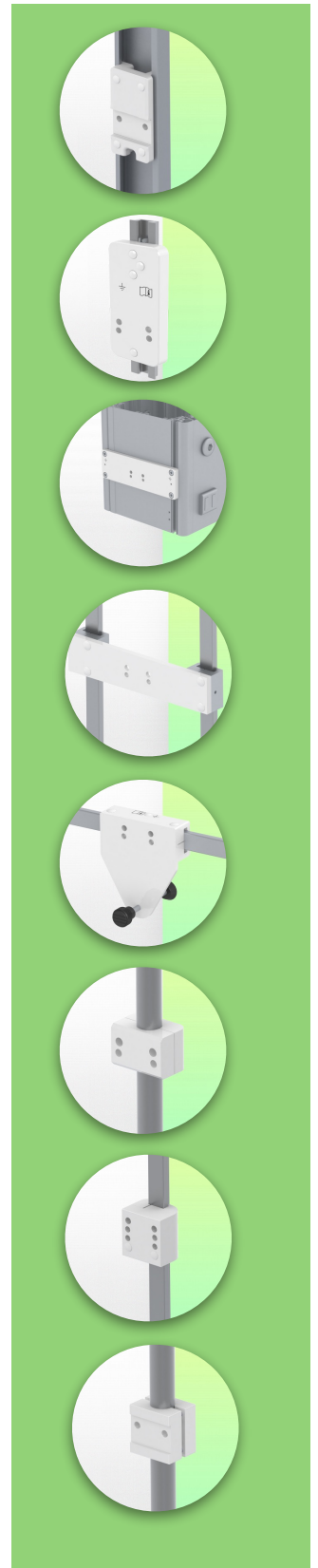

Technical Specifications

Part Number: WM 996.117

500 mm medical column with arm for two horizontal screens side by side

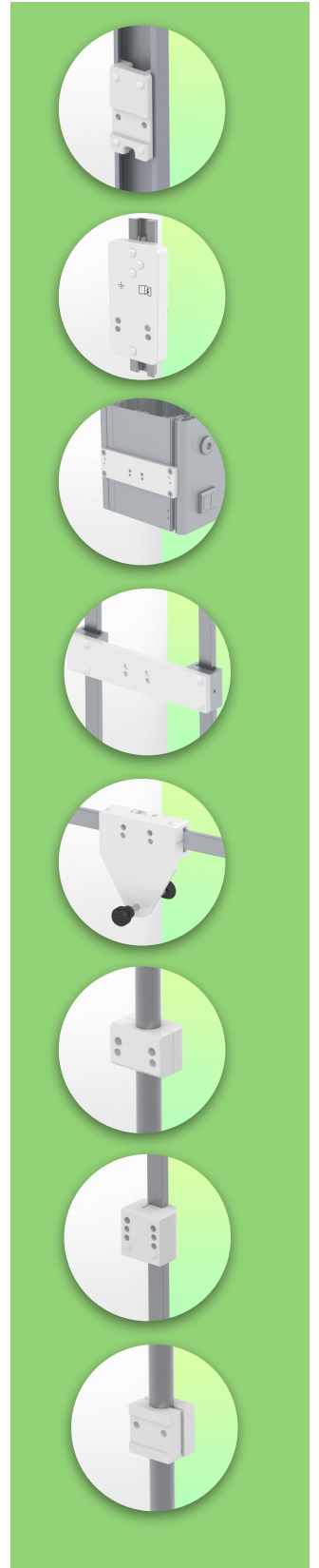
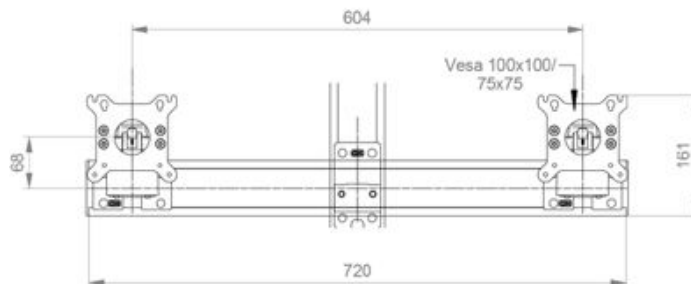
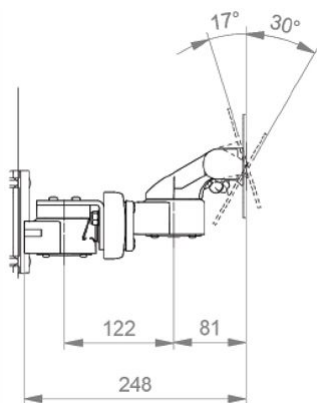
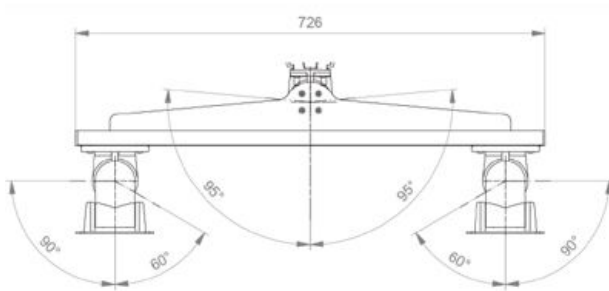

Monitor adaptation: VESA 75/100 mm Colour: Decorative parts: RAL 5013 cobalt blue Aluminium parts: RAL 9016 traffic white

Max. load capacity of support arm: 18 kg Monitor adaptation max. load: 18 Kg

Product weight: 12 Kg

Mounting Information - Wall Slide Rail

Part Number: WM 996.117

500 mm medical column with arm for two horizontal screens side by side

Table column 300 mm or 500 mm:

To install this medical arm, you need to use one of our medical columns. These are available in standard heights of 500 and 300 mm. Custom heights are available on request. Slide covers and end caps are supplied with every order.

