

## Presentation

Part Number: WM 996.123

### 300 mm medical column with two back-to-back arms for four screens

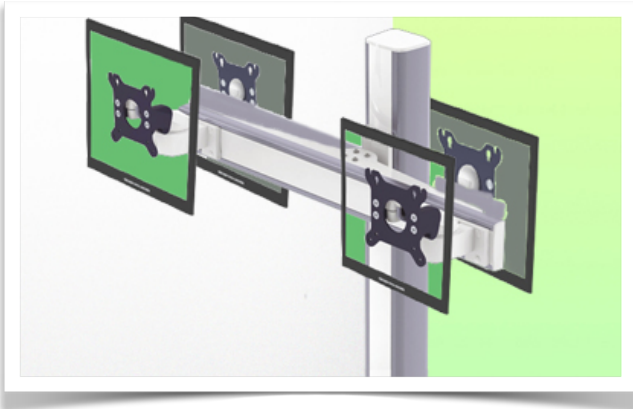

Cette colonne possède deux rails de fixation pour les différents éléments qui y seront fixés.  
1 rail à l'avant de la colonne,  
1 rail à l'arrière

Deze kolom heeft twee bevestigings rails voor de verschillende elementen die eraan zullen worden bevestigd.  
1 rail aan de voorkant van de kolom,  
1 rail aan de achterkant

This column has two fixing rails for the various elements that will be fixed to it. (1 rail at the front of the column, 1 rail at the back)

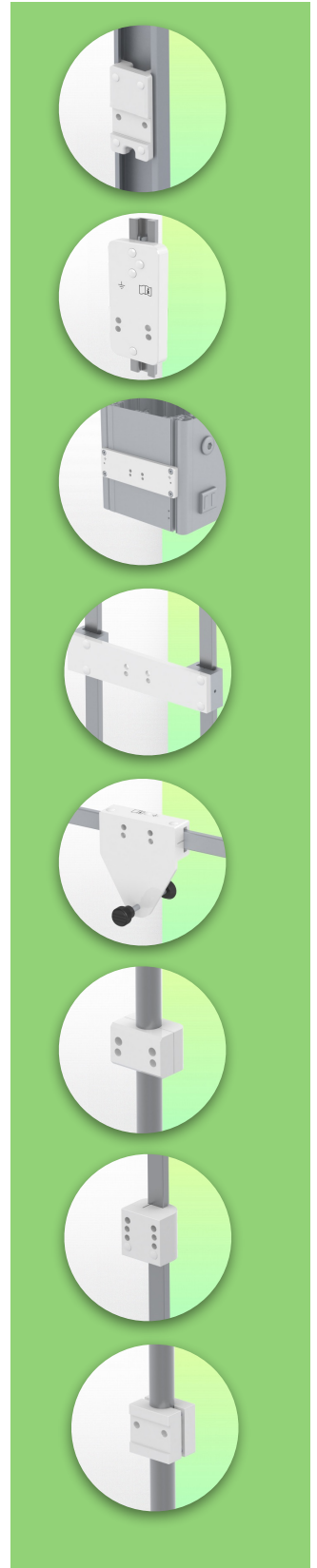
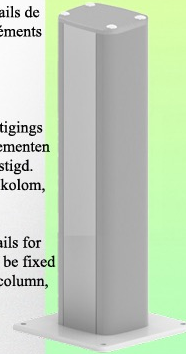

### 300 mm medical column with two back-to-back arms for four screens

This 300 mm medical column arm allows four LCD screens to be perfectly fixed, oriented and adjusted, placed back to back. It is coated with an anti-microbial agent to ensure hygiene and cleaning in every detail. Its modern design has been specially developed for healthcare environments.

#### Technical features:

- \* Integrated cable management
- \* This column can be easily cut to size.  
All cables are routed through the column, the horizontal rail and the mini arms. All cables run through the column, the horizontal rail and the mini arms. No cables are visible. Two cable covers  
Two cable covers are supplied with this configuration.
- \* The column has a front and rear panel that can be used to add other elements.  
The column has a front and rear panel that allows for additional elements to be added, which simply slide into the column and adjust to the desired height.  
The column has a front and a back panel to add other elements, which simply slide into the column and are then adjusted to the desired height and fixed.  
(see our accessories)
- \* The heads of the 4 mini arms, conform to the standard for mounting screens VESA MIS-D 75 mm and 100 mm. Rotating tilt head.
- \* Compatible with screens weighing up to 8 kg.
- \* Stability of the touch screen.
- \* Mounting of 4 screens back to back
- \* Screen tilt: 30° down and 17° up
- \* Screen rotation: 60°/90° right, 90°/60° left.
- \* Horizontal arm rotation: 95° right, 95° left.
- \* Length of horizontal arms: 728 mm
- \* Height of the column: 300 mm
- \* Compatible with multimedia terminals (TMM)
- \* Colour RAL 7024 (Graphite grey) and White
- \* All our medical arms are in compliance with :  
CE, ROHS, Medical Grade, Regulations MDD 93/42 ECC.
- \* Warranty: 5 years

**Technical Specifications**

**Part Number: WM 996.123**

**300 mm medical column with two back-to-back arms for four screens**

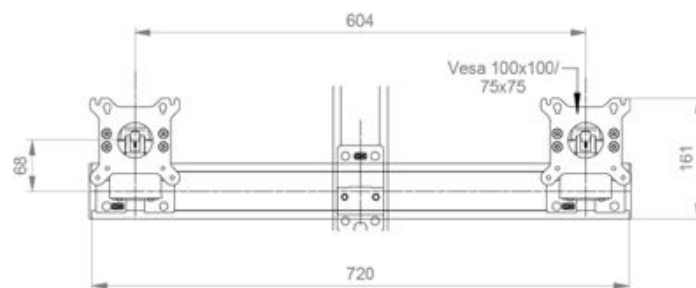
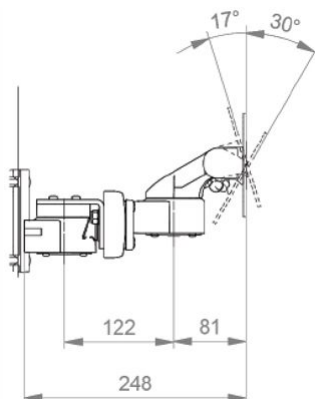
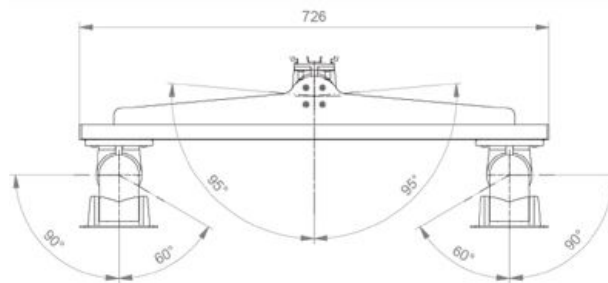
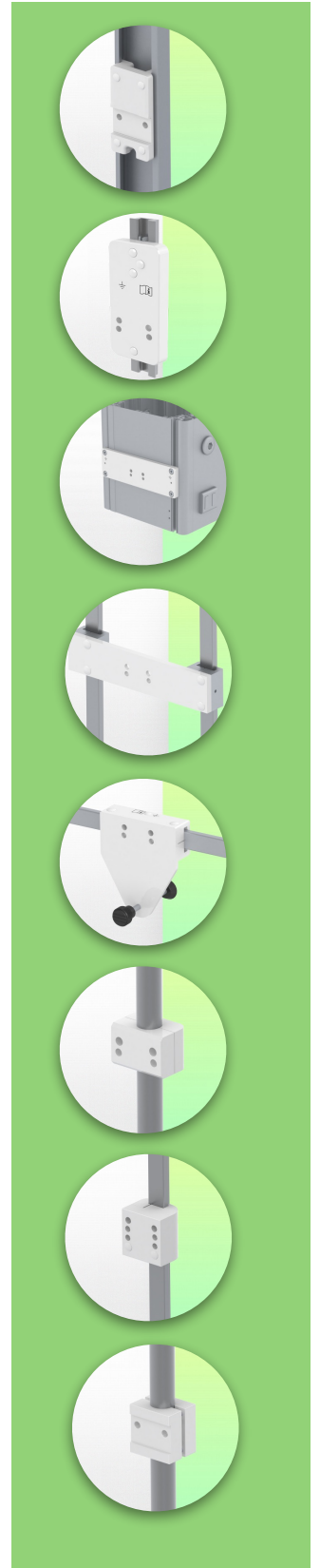
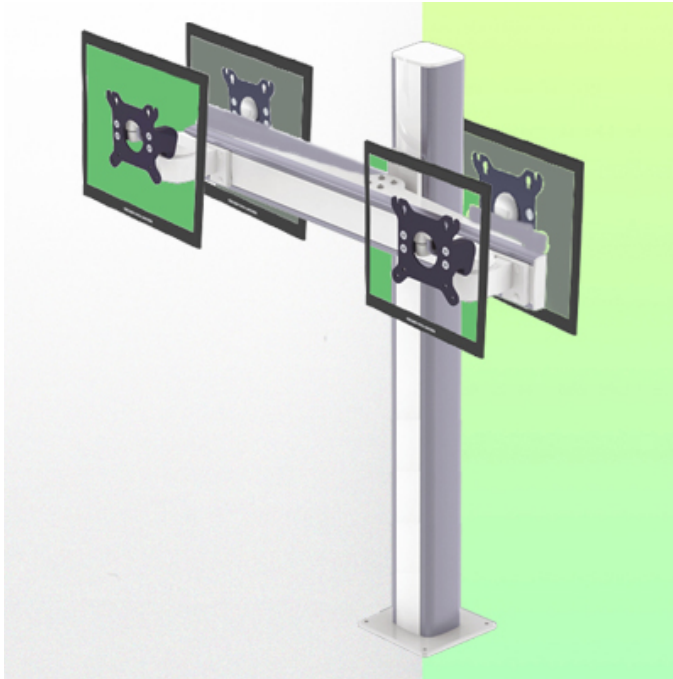

**Monitor adaptation: VESA 75/100 mm Colour: Decorative parts: RAL 5013 cobalt blue Aluminium parts: RAL 9016 traffic white**

**Max. load capacity of support arm: 8 kg per screen**

**Monitor adaptation max. load: 18 Kg Product weight: 12 Kg**

**Mounting Information - Wall Slide Rail**

**Part Number: WM 996.123**

**300 mm medical column with two back-to-back arms for four screens**

Table column 300 mm or 500 mm:

To install this medical arm, you need to use one of our medical columns. These are available in standard heights of 500 and 300 mm. Custom heights are available on request. Slide covers and end caps are supplied with every order.

