

Presentation

Part Number: WM 222.108

Medical arm with 100 mm short pivot for screen, Mounting on Amico medical device pendants and headwalls

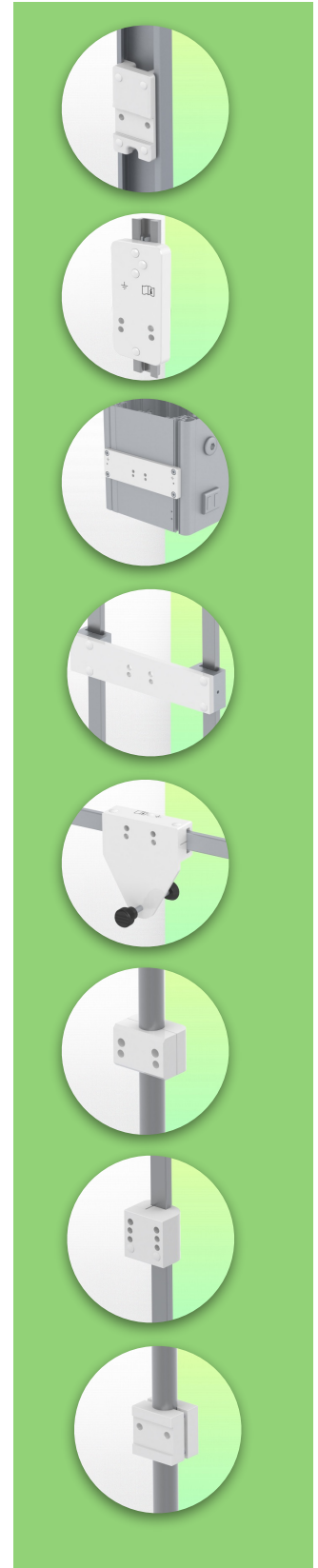
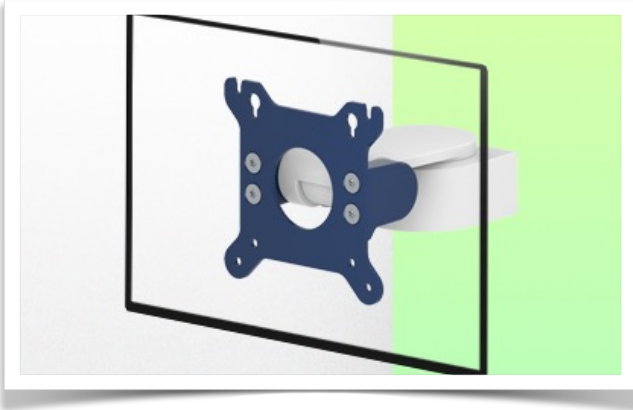

Medical arm with 100 mm short pivot for screen, Mounting on Amico medical device pendants and headwalls

This mini medical arm with a short 100 mm pivot allows the LCD screen to be perfectly fixed, oriented and adjusted. It is coated with an anti-microbial agent that provides hygiene and cleaning down to the last detail. Its modern design has been specially designed for healthcare environments.

Technical specifications:

- * Built-in cable entry
- * Mounting on Amico medical device pendants and headwalls
- * This mini swivel arm simply attaches to the Amico unit using the adapter and adjusts to the desired height and fixed. Rotating head.
- * The head of this mini arm complies with the standard for screen mounting: VESA MIS-D 75 mm and 100 mm. Compatible with screens weighing up to 18 Kg.
- * Touch screen stability.
- * Screen tilt: 50° down and 100° up
- * Screen rotation: 105° right, 105° left.
- * Total length 146 mm
- * Compatible with multimedia terminals (TMM)
- * Colour RAL 5013 cobalt blue and RAL 9016 traffic white
- * Warranty: 5 years

Technical Specifications

Part Number: WM 222.108

Medical arm with 100 mm short pivot for screen, Mounting on Amico medical device pendants and headwalls

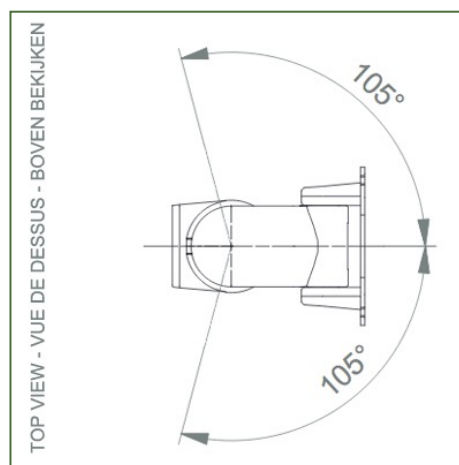
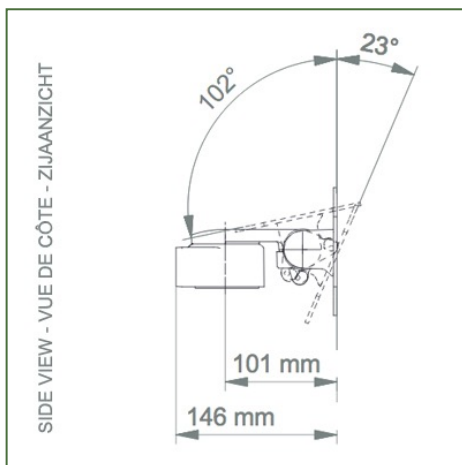
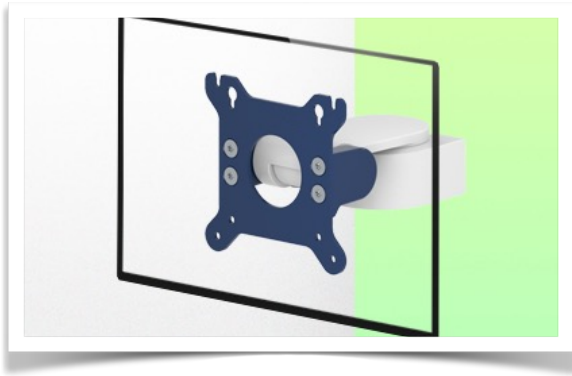

Monitor adaptation: VESA 75/100 mm

Colour: Decorative parts: RAL 5013 cobalt blue Aluminium parts: RAL 9016 traffic white

Max. load capacity of the support arm: 18 kg

Monitor adaptation Max. load capacity: 18 Kg

Product weight: 1 Kg

Points forts du produit:

Non-height adjustable arm. The extended swivel arms and swivel arms provide full cable integration and easy cleaning for infection control in all ICU areas of the clinical environment. Our 5-year warranty guarantees reliable, trouble-free and maintenance-free operation. The swivel function at the attachment point as well as the tilt and swivel function of the monitor adapter provide optimal positioning of your device. The extended swing arm is a two-part arm with a central pivot point between the two sections of the arm. All bottom-mounted monitors have the safety function of a 20° tilt stop.



Mounting Information - Adapter Amico

Part Number: WM 222.108

Medical arm with 100 mm short pivot for screen, Mounting on Amico medical device pendants and headwalls

Adapter for Amico pendants & headwalls

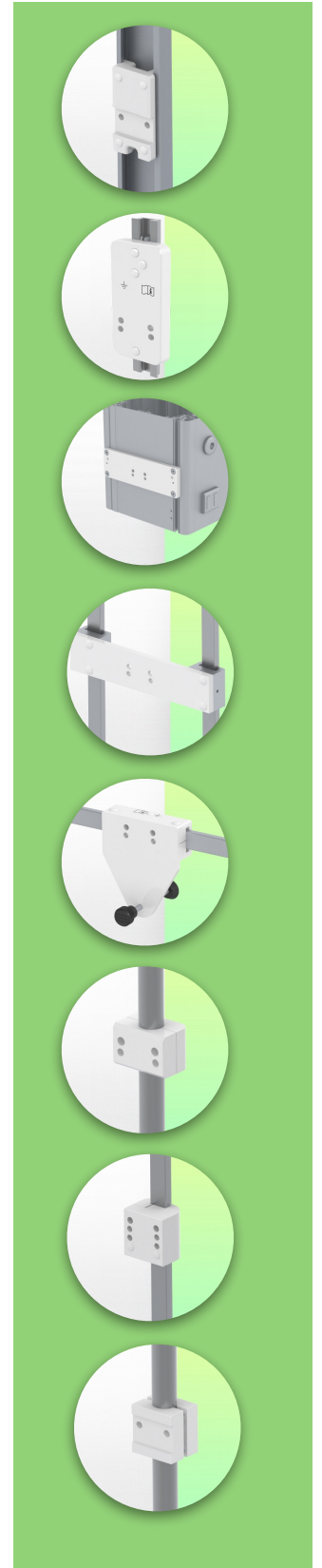

Mounting information - Mounting options

Part Number: WM 222.108

Medical arm with 100 mm short pivot for screen, Mounting on Amico medical device pendants and headwalls

Where do you want to mount the support arm?

At the hospital, there are different ways to fix our brackets: round tube, standard rail, wall rail or on an anaesthesia machine. We will always provide you with the adapter you need.



Adapter for vertical wall slide
For wall slide mounting



Adapter for Amico remote controls and wall panels

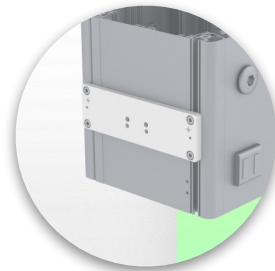

Adapter for Mindray medical power supply units



Double clamp for vertical standard rail
For mounting on two parallel vertical standard rails 10 x 25 mm

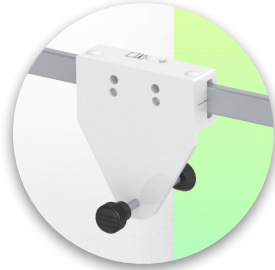

Fixed clamp for a standard rail
For mounting on a horizontal standard rail 10 x 25, 8 x 35, 10 x 30, 10 x 50 mm

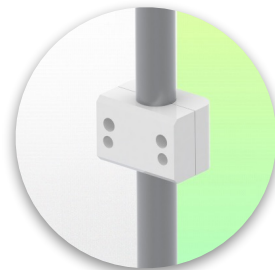

Fixed clamp for round tube
For mounting on round tube \varnothing 25, 35, 38 mm



Adapter for Maquet anaesthesia machines
Cone Adapter for Model FLOW i



Adapter for Löwenstein anaesthesia machines
Medical Adapter for Leon / Leon plus

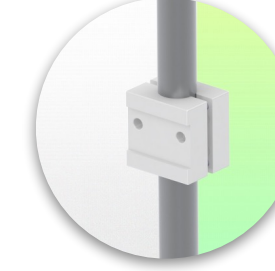

Universal round tube clamp
V-clamp for mounting on round tube \varnothing 23 - 40 mm

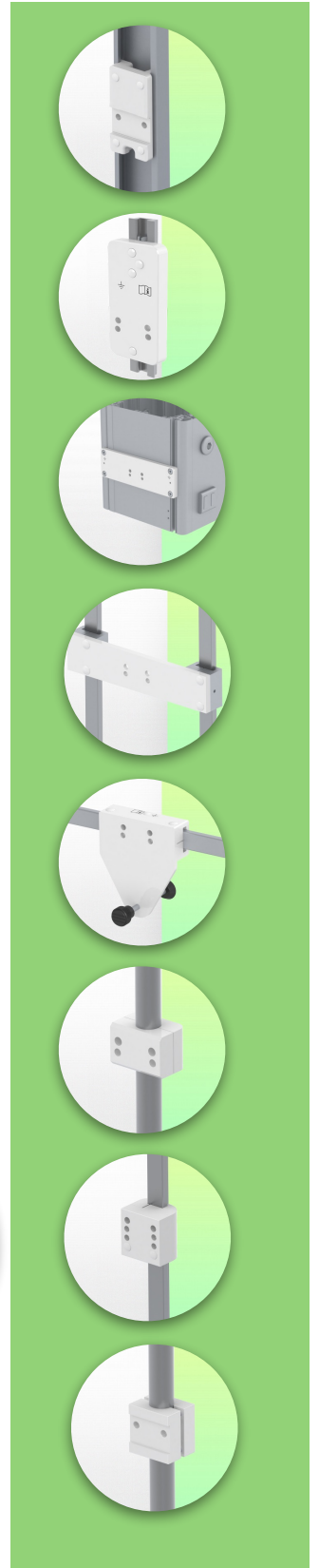

Mounting information - Mounting options

Part Number: WM 222.108

Medical arm with 100 mm short pivot for screen, Mounting on Amico medical device pendants and headwalls

Where do you want to mount the support arm?

At the hospital, there are different ways to fix our brackets: round tube, standard rail, wall rail or on an anaesthesia machine. We will always provide you with the adapter you need.

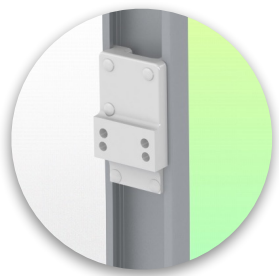

Adapter for anaesthesia machine (all suppliers)

H 80 mm, with existing side rail

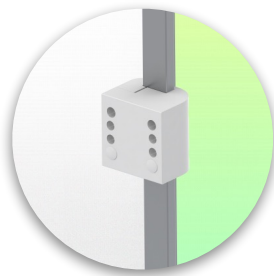

Clamp for a vertical standard rail

For mounting on standard rail 10 x 25 mm

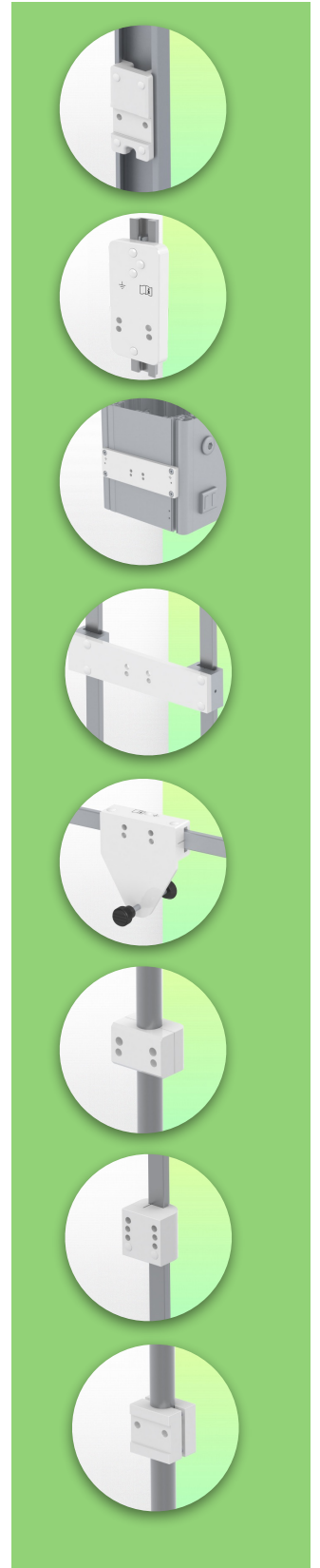

Compatible accessories for this mount

Part Number: WM 222.108

Medical arm with 100 mm short pivot for screen, Mounting on Amico medical device pendants and headwalls

Compatible accessories for this short pivot arm

You can complete your installation with these additional accessories:



Triple hook for cable For mounting on support arm



Double hook for cable For mounting on support arm



Downward pole with cable hook For mounting on support arm

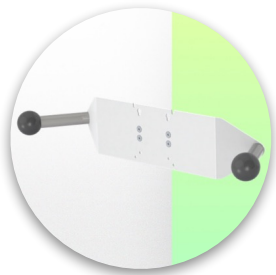

Double handle with VESA mounting For VESA monitors



Handle for VESA monitor support For VESA monitors



Considered to be the world's best in advanced hygiene control, our medical mounting systems include cable integration, a 5-year maintenance-free warranty and medical grade compliance. We're simply the best in the world at what we do.

