

**Presentation**

**Part Number: WM 222.130CT**

**2 x 300 mm swivelling Horizontal Medical Arm for screen (Heavy Duty applications up to 18 Kg), table column mount**

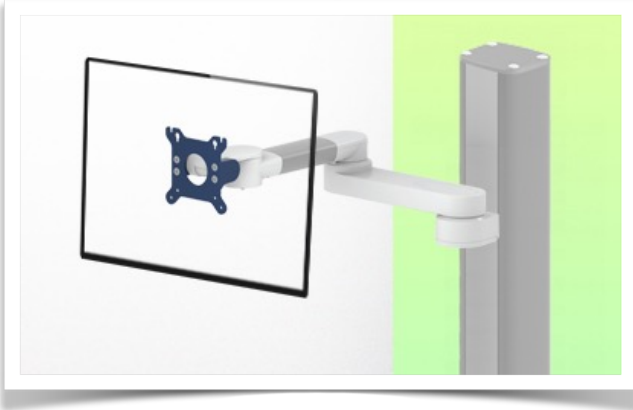

Cette colonne possède deux rails de fixation pour les différents éléments qui y seront fixés.  
1 rail à l'avant de la colonne,  
1 rail à l'arrière

Deze kolom heeft twee bevestigings rails voor de verschillende elementen die eraan zullen worden bevestigd.  
1 rail aan de voorkant van de kolom,  
1 rail aan de achterkant

This column has two fixing rails for the various elements that will be fixed to it. 1 rail at the front of the column,  
1 rail at the back)

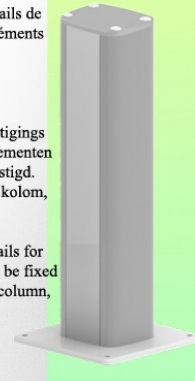

**2 x 300 mm swivelling Horizontal Medical Arm for screen (Heavy Duty applications up to 18 Kg), table column mount**

The extension allows the swivel arm to go further into the room and closer to the patient or the intended work area. It can be folded against its mounting point for clean storage when not in use. Suitable for devices up to 18 kg. This 2 x 300 mm swivelling Horizontal Arm allows the LCD screen to be perfectly fixed, oriented and adjusted. It is coated with an anti-microbial agent for hygiene and cleaning down to the last detail. Its modern design has been specially designed for healthcare environments.

**Technical specifications:**

- \* Built-in cable entry
- \* Optional table columns are available in various heights (500 - 300 mm). These columns can be easily cut to size. All cables are also routed through the column. (See Option on the following pages)
- \* This 2 x 300 mm swivelling Horizontal Arm simply slides into the column rail and then adjusts to the desired height and secures. It has no height adjustment.
- \* The head of this arm complies with the VESA MIS-D 75 mm and 100 mm screen mounting standard.
- \* Compatible with screens weighing up to 18 kg
- \* Touch screen stability. \* Screen tilt: 50° down and 100° up
- \* Screen rotation: 110° right, 110° left. \* Total length 607 mm
- \* Colour RAL 5013 cobalt blue and RAL 9016 traffic white
- \* Warranty: 5 years.



## Technical Specifications

Part Number: WM 222.130CT

**2 x 300 mm swivelling Horizontal Medical Arm for screen (Heavy Duty applications up to 18 Kg), table column mount**

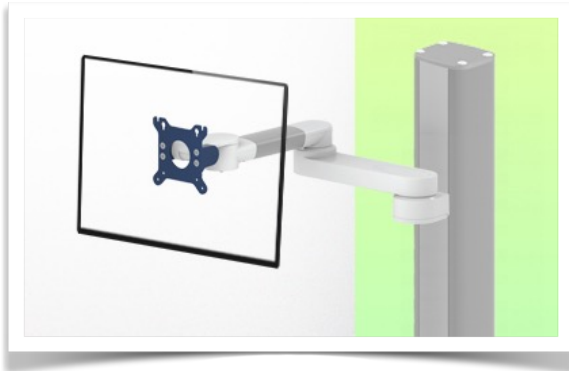

Cette colonne possède deux rails de fixation pour les différents éléments qui y seront fixés.  
1 rail à l'avant de la colonne,  
1 rail à l'arrière

Deze kolom heeft twee bevestigings rails voor de verschillende elementen die eraan zullen worden bevestigd.  
1 rail aan de voorkant van de kolom,  
1 rail aan de achterkant

This column has two fixing rails for the various elements that will be fixed to it. 1 rail at the front of the column,  
1 rail at the back)

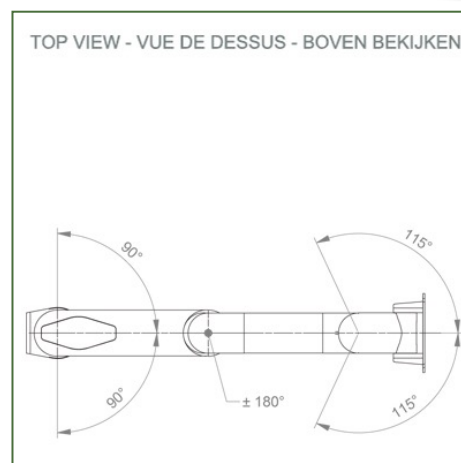
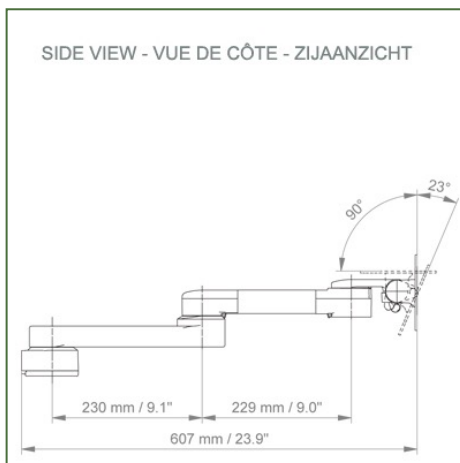
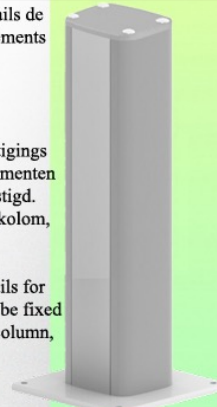

**Monitor adaptation:** VESA 75/100 mm

**Colour:** Decorative parts: RAL 5013 cobalt blue Aluminium parts: RAL 9016 traffic white

**Max. load capacity of the support arm:** 18 kg

**Monitor adaptation Max. load capacity:** 18 Kg

**Product weight:** 3,1 Kg

### Product highlights:

Non-height adjustable arm. The extended swivel arms and swivel arms provide full cable integration and easy cleaning for infection control in all ICU areas of the clinical environment. Our 5-year warranty guarantees reliable, trouble-free and maintenance-free operation. The swivel function at the attachment point as well as the tilt and swivel function of the monitor adapter provide optimal positioning of your device. The extended swing arm is a two-part arm with a central pivot point between the two sections of the arm. All bottom-mounted monitors have the safety function of a 20° tilt stop.

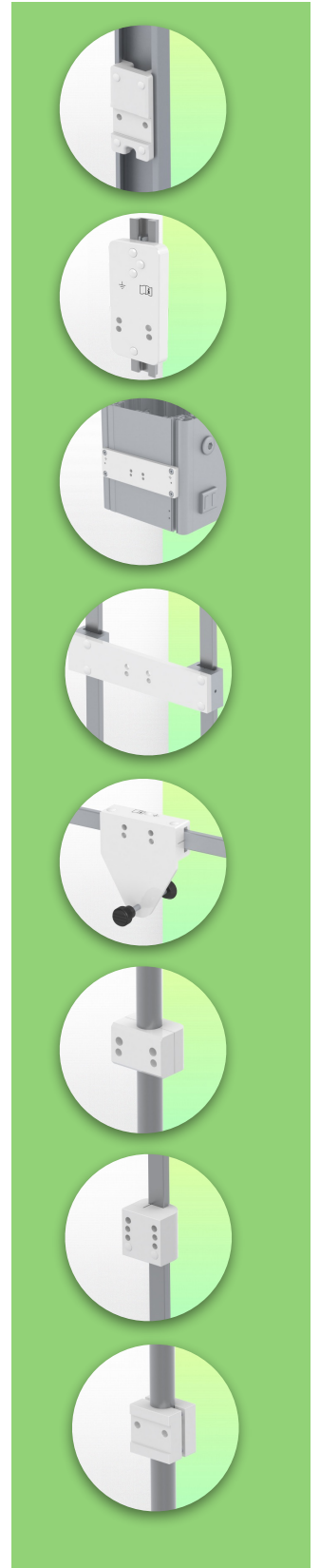

**Mounting Information - Wall Slide Rail**

**Part Number: WM 222.130CT**

**2 x 300 mm swivelling Horizontal Medical Arm for screen (Heavy Duty applications up to 18 Kg), table column mount**

**Table column:**

To install this medical arm, you need to use one of our medical columns. These are available in standard heights of 500 and 300 mm. Custom heights are available on request. Slide covers and end caps are supplied with every order.

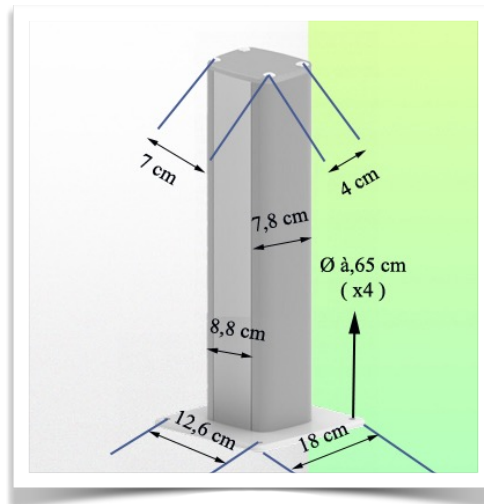
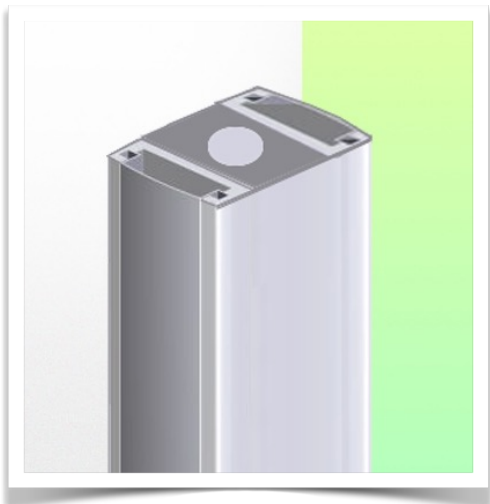
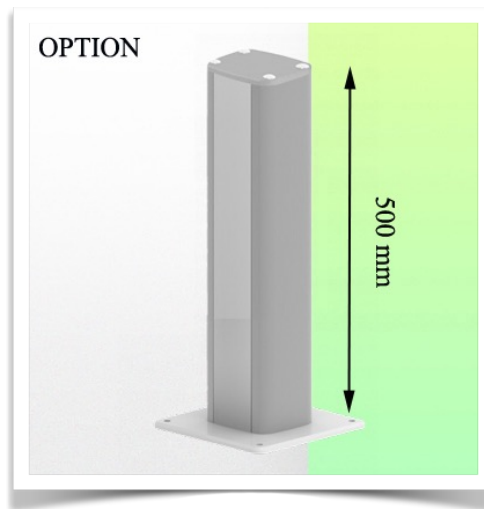
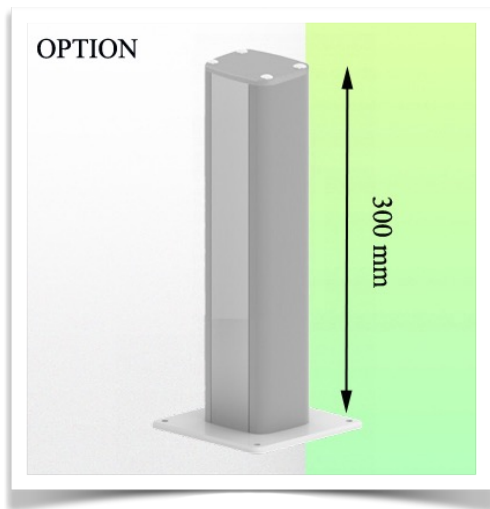

**Mounting information - Mounting options**

**Part Number: WM 222.130CT**

**2 x 300 mm swivelling Horizontal Medical Arm for screen (Heavy Duty applications up to 18 Kg), table column mount**

**Where do you want to mount the support arm?**

At the hospital, there are different ways to fix our brackets: round tube, standard rail, wall rail or on an anaesthesia machine. We will always provide you with the adapter you need.

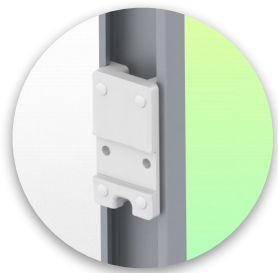

**Adapter for vertical wall slide**  
For wall slide mounting



**Adapter for Amico remote controls and wall panels**



**Adapter for Mindray medical power supply units**



**Double clamp for vertical standard rail**  
For mounting on two parallel vertical standard rails 10 x 25 mm



**Fixed clamp for a standard rail**  
For mounting on a horizontal standard rail 10 x 25, 8 x 35, 10 x 30, 10 x 50 mm



**Fixed clamp for round tube**  
For mounting on round tube  $\varnothing$  25, 35, 38 mm

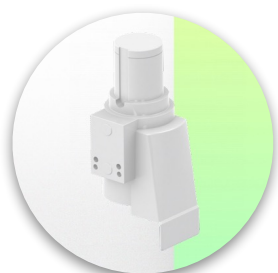

**Adapter for Maquet anaesthesia machines**  
Cone Adapter for Model FLOW i



**Adapter for Löwenstein anaesthesia machines**  
Medical Adapter for Leon / Leon plus



**Universal round tube clamp**  
V-clamp for mounting on round tube  $\varnothing$  23 - 40 mm



**Mounting information - Mounting options**

**Part Number: WM 222.130CT**

**2 x 300 mm swivelling Horizontal Medical Arm for screen (Heavy Duty applications up to 18 Kg), table column mount**

**Where do you want to mount the support arm?**

At the hospital, there are different ways to fix our brackets: round tube, standard rail, wall rail or on an anaesthesia machine. We will always provide you with the adapter you need.



**Adapter for anaesthesia machine (all suppliers)**

H 80 mm, with existing side rail

**Clamp for a vertical standard rail**

For mounting on standard rail 10 x 25 mm

**Table column**

500 mm or 300 mm

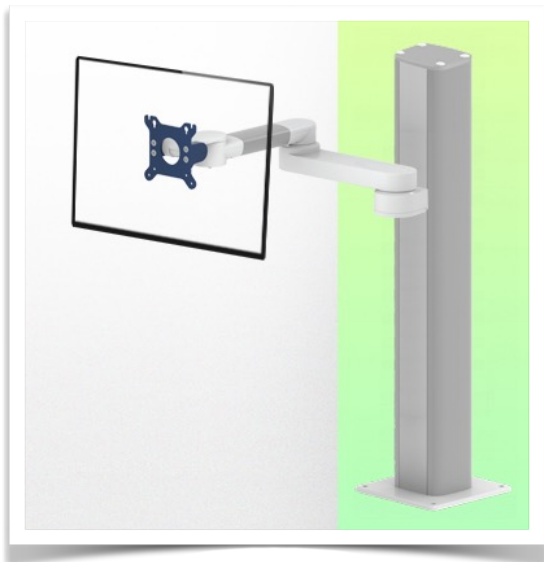

Considered to be the world's best in advanced hygiene control, our medical mounting systems include cable integration, a 5-year maintenance-free warranty and medical grade compliance. We're simply the best in the world at what we do.

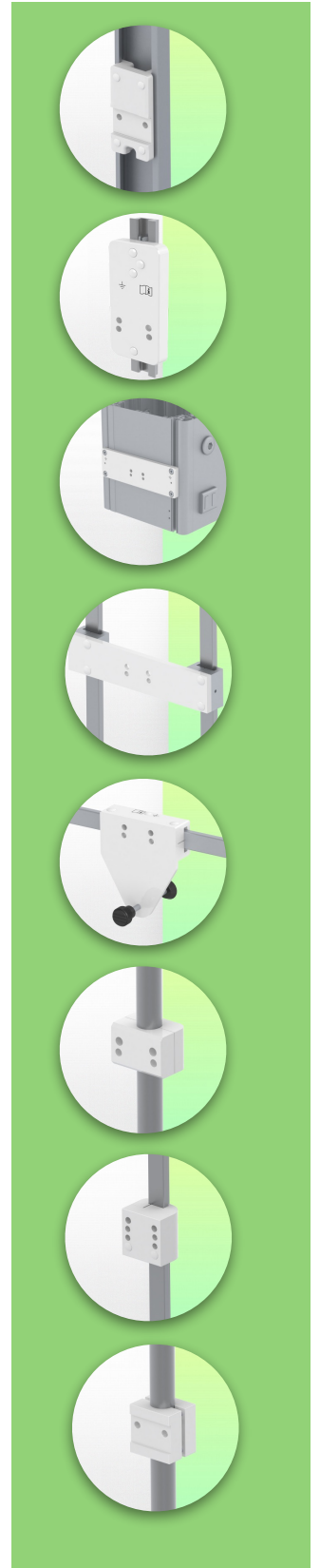

**Compatible accessories for this mount**

**Part Number: WM 222.130CT**

**2 x 300 mm swivelling Horizontal Medical Arm for screen (Heavy Duty applications up to 18 Kg), table column mount**

**Compatible accessories for this arm**

You can complete your installation with these additional accessories:



**Triple hook for cable** For mounting on support arm



**Double hook for cable** For mounting on support arm



**Downward pole with cable hook** For mounting on support arm



**Double handle with VESA mounting** For VESA monitors



**Handle for VESA monitor support** For VESA monitors



**Double hook for cable** For mounting on a wall or column rail



**Triple hook for cable** For wall or column rail mounting



**Basket** For wall or column rail mounting



**Downward Pole** For mounting on support arm

