

Presentation

Part Number: WM 222.136

Horizontal swivelling Medical Arm 2 x 300 mm for screen (Heavy Duty applications up to 18 Kg), Variable Pole Mount from 23 to 40 mm

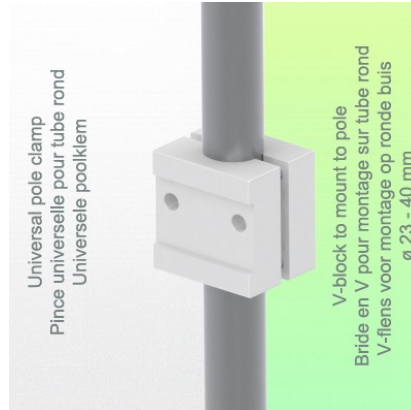
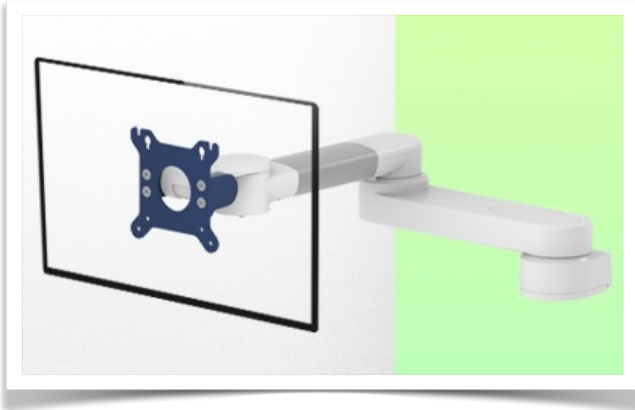

Horizontal swivelling Medical Arm 2 x 300 mm for screen (Heavy Duty applications up to 18 Kg), Variable Pole Mount from 23 to 40 mm

The extension allows the swivel arm to go further into the room and closer to the patient or the intended work area. It can be folded against its mounting point for clean storage when not in use. Suitable for devices up to 18 kg. This 2 x 300 mm swivelling Horizontal Arm allows the LCD screen to be perfectly fixed, oriented and adjusted. It is coated with an anti-microbial agent for hygiene and cleaning down to the last detail. Its modern design has been specially designed for healthcare environments.

Technical specifications:

- * Built-in cable passage
- * Pole mount variable from 23 to 40 mm
- * This medical arm simply attaches to the pole and then adjusts to the tube and is clamped with the two grips. It has no height adjustment.
- * The head of this arm complies with the VESA MIS-D 75 mm and 100 mm screen mounting standard. Rotary head.
- * Compatible with screens weighing up to 18 Kg. Length 607 mm
- * Screen tilt: 50° downwards and 100° upwards
- * Screen rotation: 110° right, 110° left.
- * All our medical arms are CE, ROHS, Medical Grade, Regulations MDD 93/42 ECC compliant.
- * Color RAL 5013 cobalt blue and RAL 9016 traffic white
- * Warranty: 5 years

Technical Specifications

Part Number: WM 222.136

Horizontal swivelling Medical Arm 2 x 300 mm for screen (Heavy Duty applications up to 18 Kg), Variable Pole Mount from 23 to 40 mm

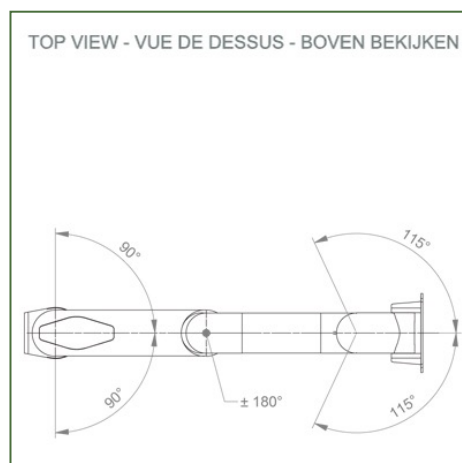
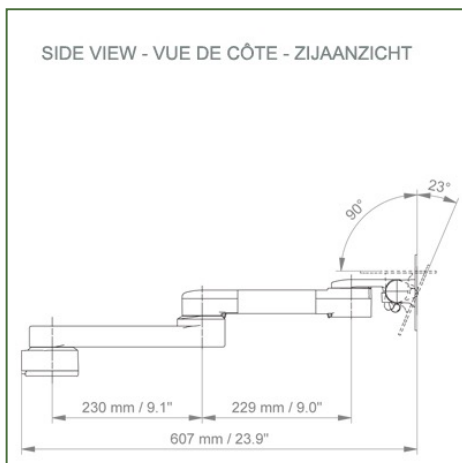
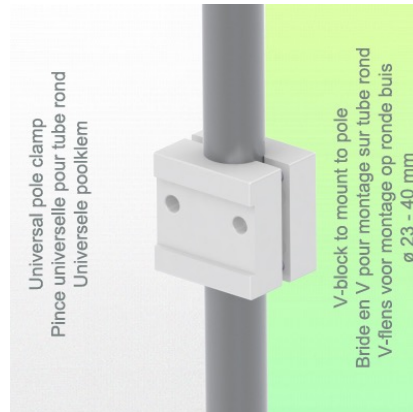
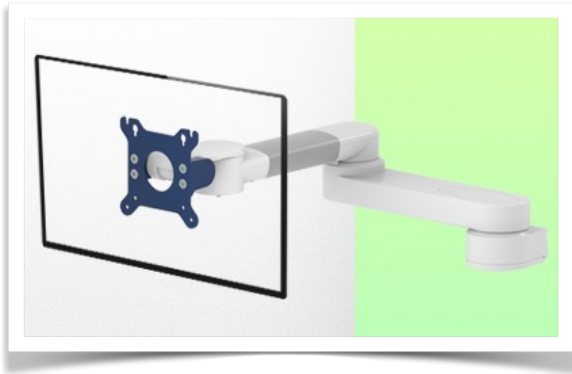

Monitor adaptation: VESA 75/100 mm

Colour: Decorative parts: RAL 5013 cobalt blue Aluminium parts: RAL 9016 traffic white

Max. load capacity of the support arm: 8 kg

Monitor adaptation Max. load capacity: 8 Kg

Product weight: 2,8 Kg

Points forts du produit:

Non-height adjustable arm. The extended swivel arms and swivel arms provide full cable integration and easy cleaning for infection control in all ICU areas of the clinical environment. Our 5-year warranty guarantees reliable, trouble-free and maintenance-free operation. The swivel function at the attachment point as well as the tilt and swivel function of the monitor adapter provide optimal positioning of your device. The extended swing arm is a two-part arm with a central pivot point between the two sections of the arm. All bottom-mounted monitors have the safety function of a 20° tilt stop.

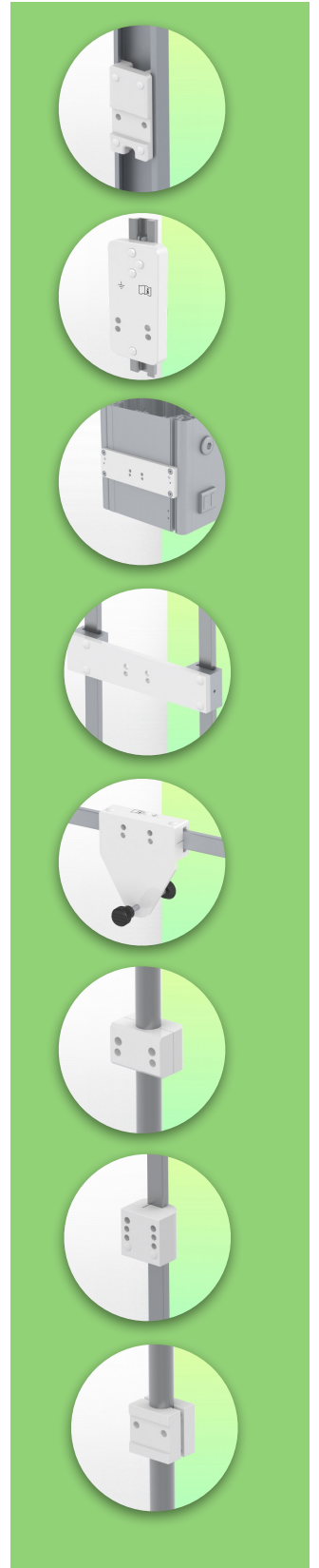

Mounting Information - Fixed pole clamp

Part Number: WM 222.136

Horizontal swivelling Medical Arm 2 x 300 mm for screen (Heavy Duty applications up to 18 Kg), Variable Pole Mount from 23 to 40 mm

Variable pole clamp:

Variable Pole mounting \varnothing 23 - 40 mm

* Please specify the diameter of the Pole when ordering.

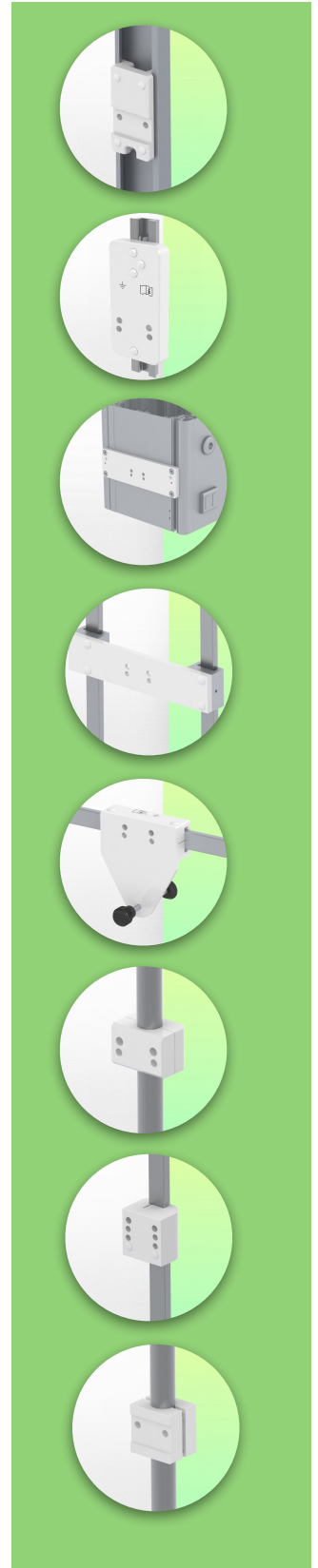
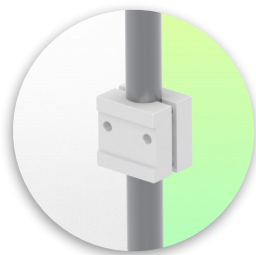
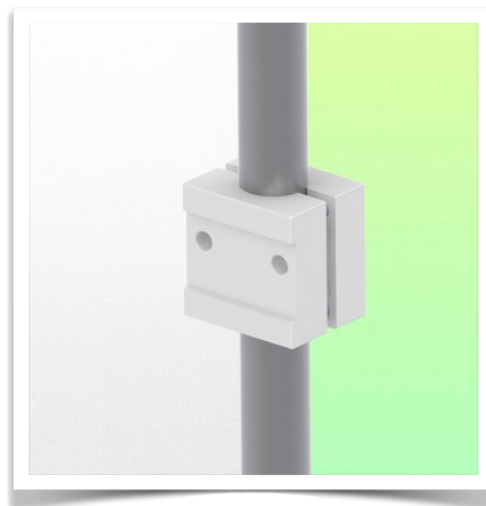

Mounting information - Mounting options

Part Number: WM 222.136

Horizontal swivelling Medical Arm 2 x 300 mm for screen (Heavy Duty applications up to 18 Kg), Variable Pole Mount from 23 to 40 mm

Where do you want to mount the support arm?

At the hospital, there are different ways to fix our brackets: round tube, standard rail, wall rail or on an anaesthesia machine. We will always provide you with the adapter you need.



Adapter for vertical wall slide
For wall slide mounting



Adapter for Amico remote controls and wall panels

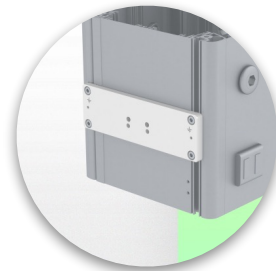

Adapter for Mindray medical power supply units



Double clamp for vertical standard rail
For mounting on two parallel vertical standard rails 10 x 25 mm

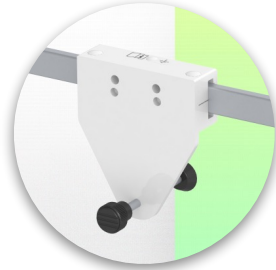

Fixed clamp for a standard rail
For mounting on a horizontal standard rail 10 x 25, 8 x 35, 10 x 30, 10 x 50 mm

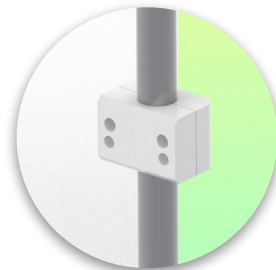

Fixed clamp for round tube
For mounting on round tube \varnothing 25, 35, 38 mm



Adapter for Maquet anaesthesia machines
Cone Adapter for Model FLOW i



Adapter for Löwenstein anaesthesia machines
Medical Adapter for Leon / Leon plus

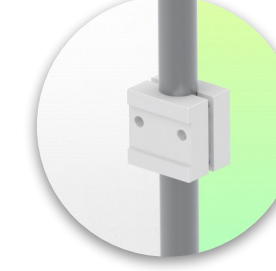

Universal round tube clamp
V-clamp for mounting on round tube \varnothing 23 - 40 mm

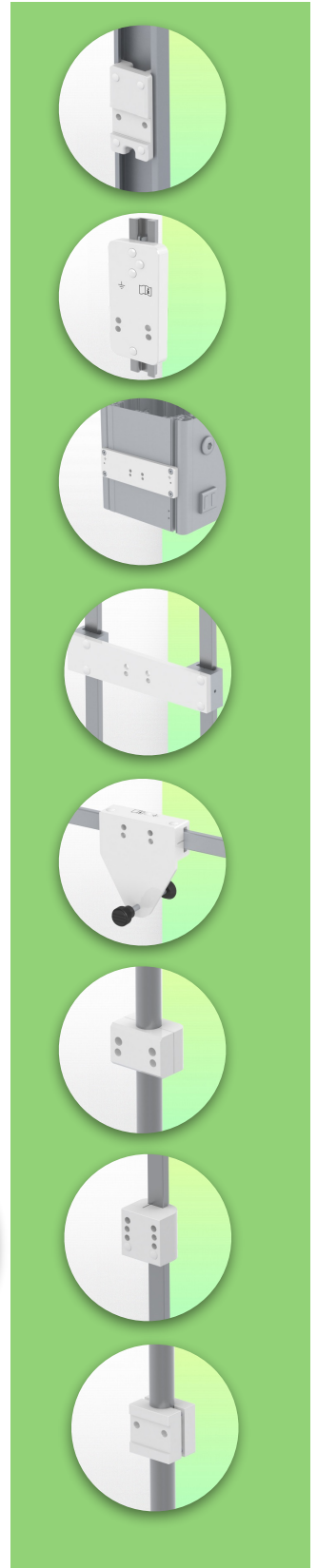

Mounting information - Mounting options

Part Number: WM 222.136

Horizontal swivelling Medical Arm 2 x 300 mm for screen (Heavy Duty applications up to 18 Kg), Variable Pole Mount from 23 to 40 mm

Where do you want to mount the support arm?

At the hospital, there are different ways to fix our brackets: round tube, standard rail, wall rail or on an anaesthesia machine. We will always provide you with the adapter you need.



Adapter for anaesthesia machine (all suppliers)

H 80 mm, with existing side rail



Clamp for a vertical standard rail

For mounting on standard rail 10 x 25 mm



Considered to be the world's best in advanced hygiene control, our medical mounting systems include cable integration, a 5-year maintenance-free warranty and medical grade compliance. We're simply the best in the world at what we do.



Compatible accessories for this mount

Part Number: WM 222.136

Horizontal swivelling Medical Arm 2 x 300 mm for screen (Heavy Duty applications up to 18 Kg), Variable Pole Mount from 23 to 40 mm

Compatible accessories for this 2 x 300 mm Horizontal Arm

You can complete your installation with these additional accessories:



Triple hook for cable
For mounting on support arm



Double hook for cable
For mounting on support arm



Downward pole with cable hook
For mounting on support arm

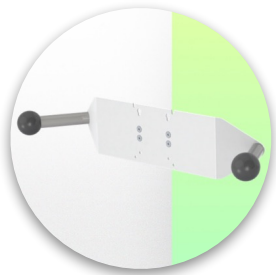

Double handle with VESA mounting
For VESA monitors



Handle for VESA monitor support
For VESA monitors



Double hook for cable
For wall or column rail mounting



Triple hook for cable
For wall or column rail mounting



Basket
For wall or column rail mounting



Downward Pole
For mounting on support arm

