

**Presentation**

**Part Number: WM 222.144CT**

**Height-adjustable medical arm, length 300 mm, table column mount.  
Supported weight balancing range from 16 to 22 Kg**

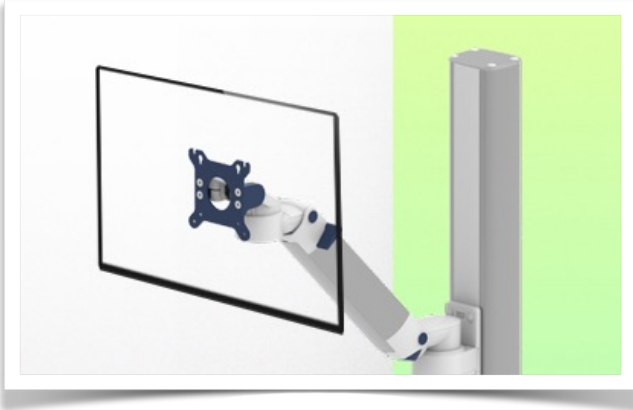

Cette colonne possède deux rails de fixation pour les différents éléments qui y seront fixés.  
1 rail à l'avant de la colonne,  
1 rail à l'arrière

Deze kolom heeft twee bevestigings rails voor de verschillende elementen die eraan zullen worden bevestigd.  
1 rail aan de voorkant van de kolom,  
1 rail aan de achterkant

This column has two fixing rails for the various elements that will be fixed to it. 1 rail at the front of the column, 1 rail at the back)

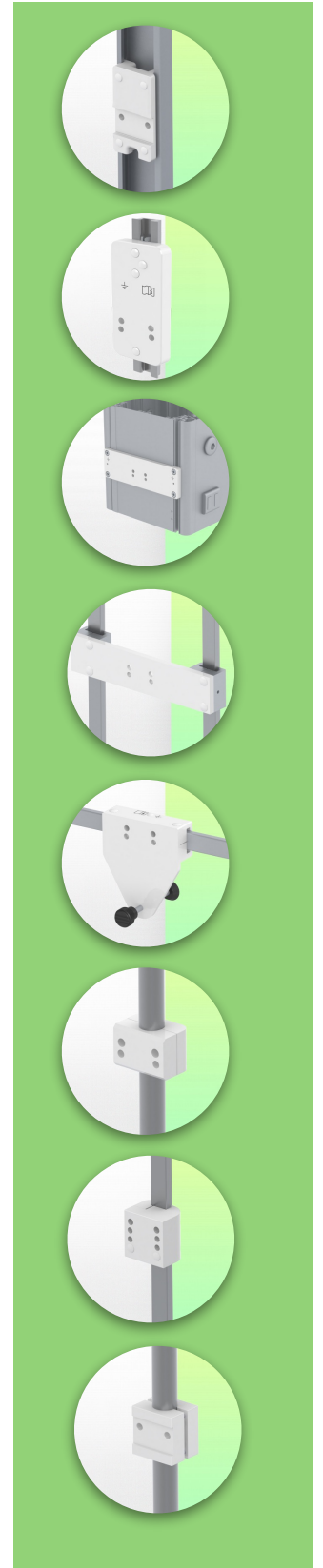
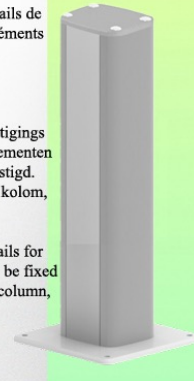

**Height-adjustable medical arm, length 300 mm, table column mount.  
Supported weight balancing range from 16 to 22 Kg**

Full cable integration and infection control with easy-to-clean surfaces make this arm the ideal product for emergency care areas. Height adjustment for ergonomic and customized monitor positioning. This 300 mm Horizontal Medical Arm with gas spring height adjustment allows the monitor to be perfectly fixed, oriented and adjusted. It is coated with an anti-microbial agent offering hygiene and cleaning in every detail. Its modern design has been specially designed for healthcare environments.

**Technical specifications:**

\* Integrated cable entry \* Equipotential bonding \* Optional table columns are available in various heights (500 - 300 mm). These columns can be easily cut to size. All cables are also routed through the column. (See Option on the following pages) \* This 300 mm Horizontal Arm with gas spring simply slides into the column rail and then adjusts to the desired height and is fixed in place. It has a height adjustment safety stop button, which allows the arm to remain in the selected position. \* The head of this arm complies with the VESA MIS-D 75 mm and 100 mm screen mounting standard.\* Compatible with screens weighing no more than 16-22 Kg.\* Touch screen stability. \* Screen tilt: 30° down and 90° up \* Screen rotation: 130° right, 180° left. \* Arm rotation: 90° right, 90° left \* Height adjustment: 45° down, 45° up \* Total length 578 mm \* All our medical arms are CE, ROHS, Medical Grade, Regulations MDD 93/42 ECC compliant. \* Colour RAL 5013 cobalt blue and RAL 9016 traffic white \* Warranty: 5 years

## Technical Specifications

Part Number: WM 222.144CT

Height-adjustable medical arm, length 300 mm, table column mount.  
Supported weight balancing range from 16 to 22 Kg

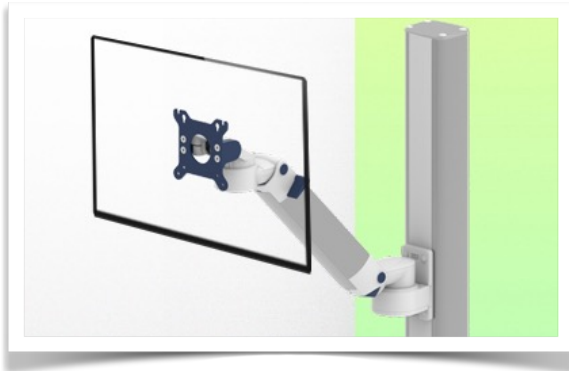

Cette colonne possède deux rails de fixation pour les différents éléments qui y seront fixés.  
1 rail à l'avant de la colonne,  
1 rail à l'arrière

Deze kolom heeft twee bevestigings rails voor de verschillende elementen die eraan zullen worden bevestigd.  
1 rail aan de voorkant van de kolom,  
1 rail aan de achterkant

This column has two fixing rails for the various elements that will be fixed to it. 1 rail at the front of the column,  
1 rail at the back)

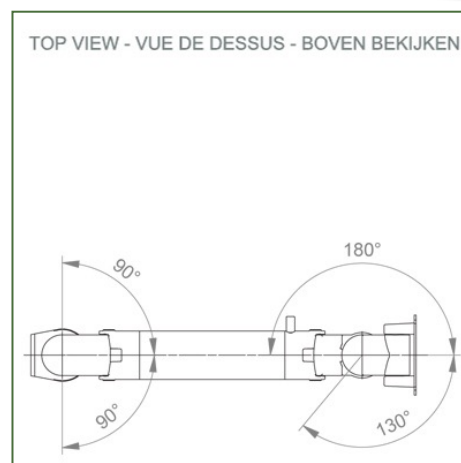
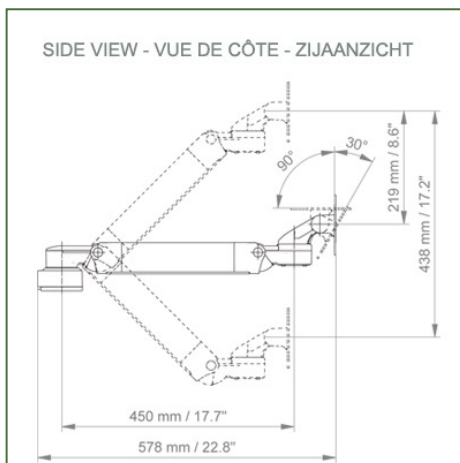
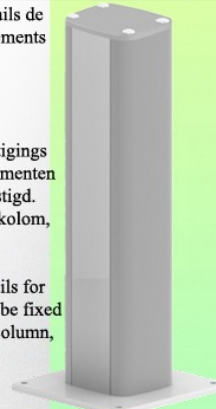

**Monitor adaptation:** VESA 75/100 mm  
**Colour:** Decorative parts: RAL 5013 cobalt blue  
**Aluminium parts:** RAL 9016 traffic white  
**Balancing scale for this medical arm:** 16 - 22 Kg  
**Product weight:** 3,3 Kg

**Height adjustment:** Parallel mechanism for a constant viewing angle  
**Safety:** Has a safety stop button for the height adjustment, which allows the medical arm to remain in the chosen position.

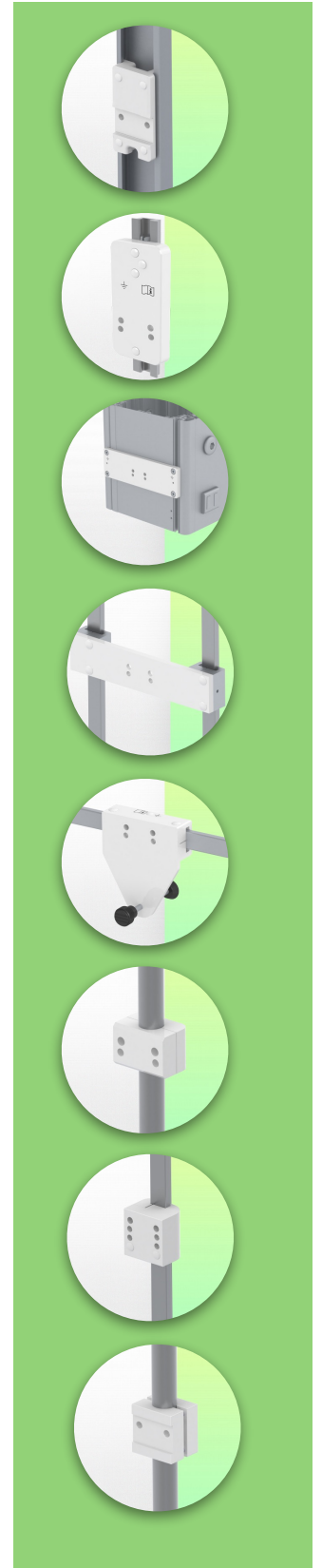

**Mounting Information - Wall Slide Rail**

**Part Number: WM 222.144CT**

**Height-adjustable medical arm, length 300 mm, table column mount.  
Supported weight balancing range from 16 to 22 Kg**

**Table column:**

To install this medical arm, you need to use one of our medical columns. These are available in standard heights of 500 and 300 mm. Custom heights are available on request. Slide covers and end caps are supplied with every order.

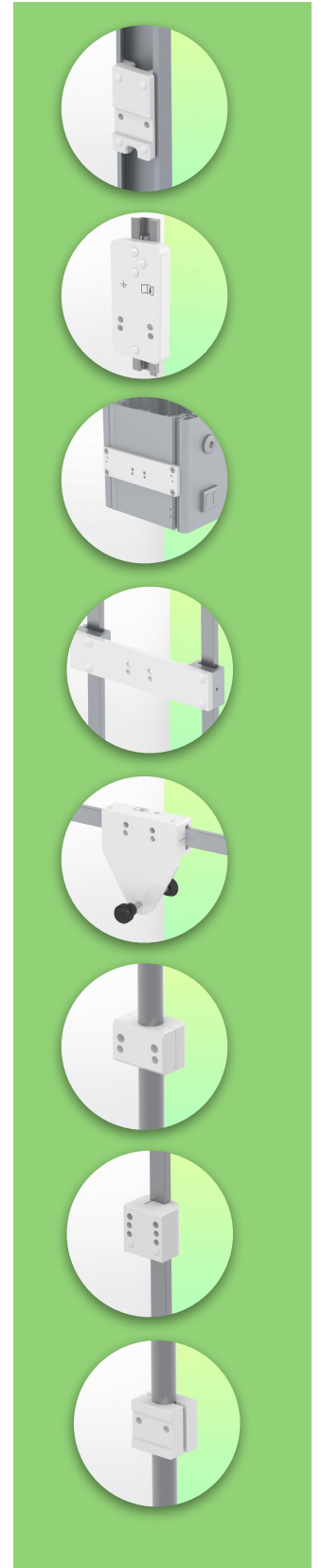
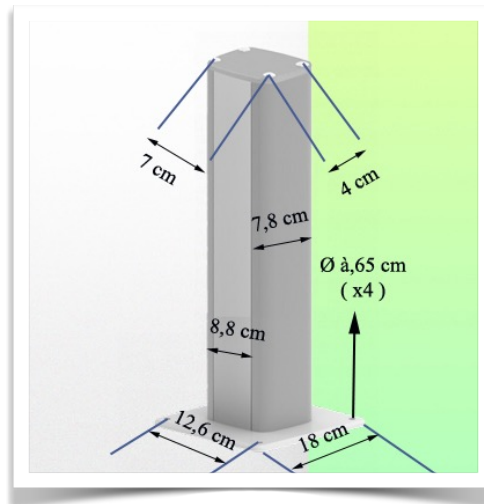
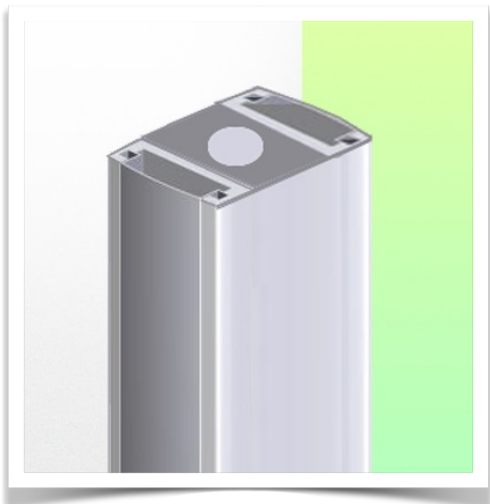
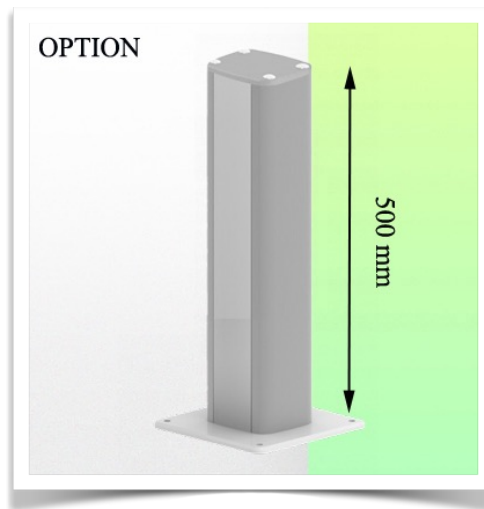
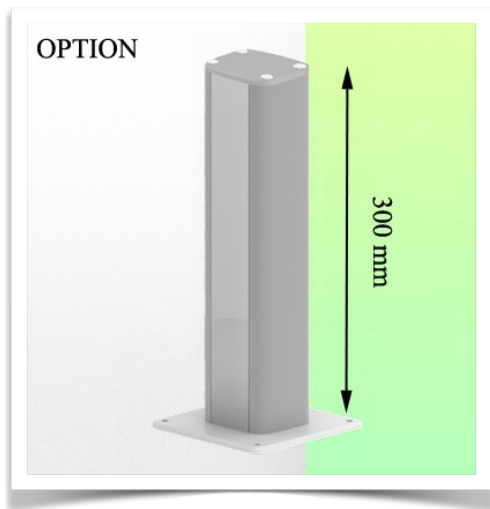

**Mounting information - Mounting options**

**Part Number: WM 222.144CT**

**Height-adjustable medical arm, length 300 mm, table column mount.  
Supported weight balancing range from 16 to 22 Kg**

**Where do you want to mount the support arm?**

At the hospital, there are different ways to fix our brackets: round tube, standard rail, wall rail or on an anaesthesia machine. We will always provide you with the adapter you need.

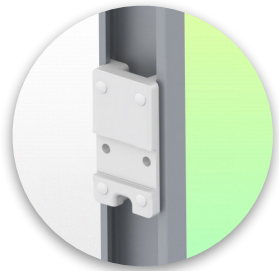

**Adapter for vertical wall slide**  
For wall slide mounting



**Adapter for Amico remote controls and wall panels**

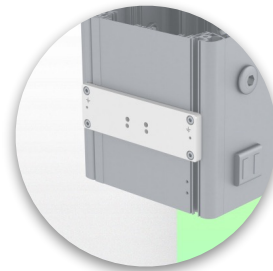

**Adapter for Mindray medical power supply units**

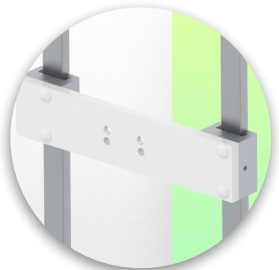

**Double clamp for vertical standard rail**  
For mounting on two parallel vertical standard rails 10 x 25 mm

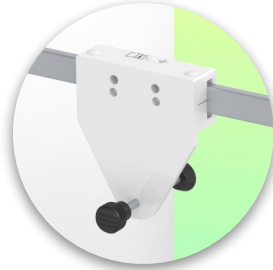

**Fixed clamp for a standard rail**  
For mounting on a horizontal standard rail 10 x 25, 8 x 35, 10 x 30, 10 x 50 mm

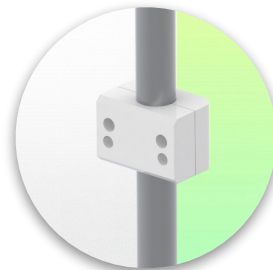

**Fixed clamp for round tube**  
For mounting on round tube  $\varnothing$  25, 35, 38 mm

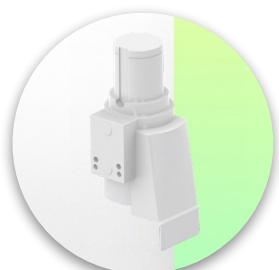

**Adapter for Maquet anaesthesia machines**  
Cone Adapter for Model FLOW i



**Adapter for Löwenstein anaesthesia machines**  
Medical Adapter for Leon / Leon plus

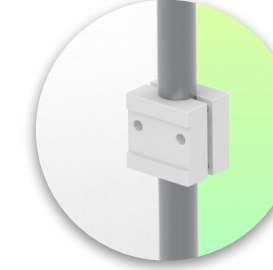

**Universal round tube clamp**  
V-clamp for mounting on round tube  $\varnothing$  23 - 40 mm

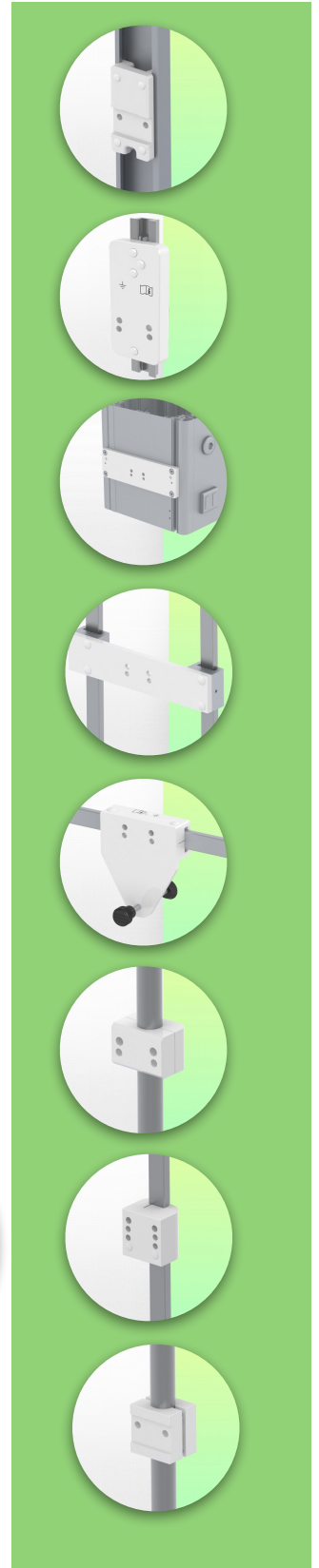

**Mounting information - Mounting options**

**Part Number: WM 222.144CT**

**Height-adjustable medical arm, length 300 mm, table column mount.  
Supported weight balancing range from 16 to 22 Kg**

**Where do you want to mount the support arm?**

At the hospital, there are different ways to fix our brackets: round tube, standard rail, wall rail or on an anaesthesia machine. We will always provide you with the adapter you need.

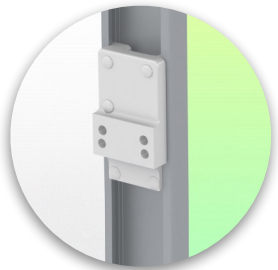

**Adapter for anaesthesia machine (all suppliers)**  
H 80 mm, with existing side rail

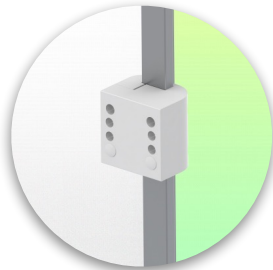

**Clamp for a vertical standard rail**  
For mounting on standard rail 10 x 25 mm



**Table column**  
500 mm or 300 mm

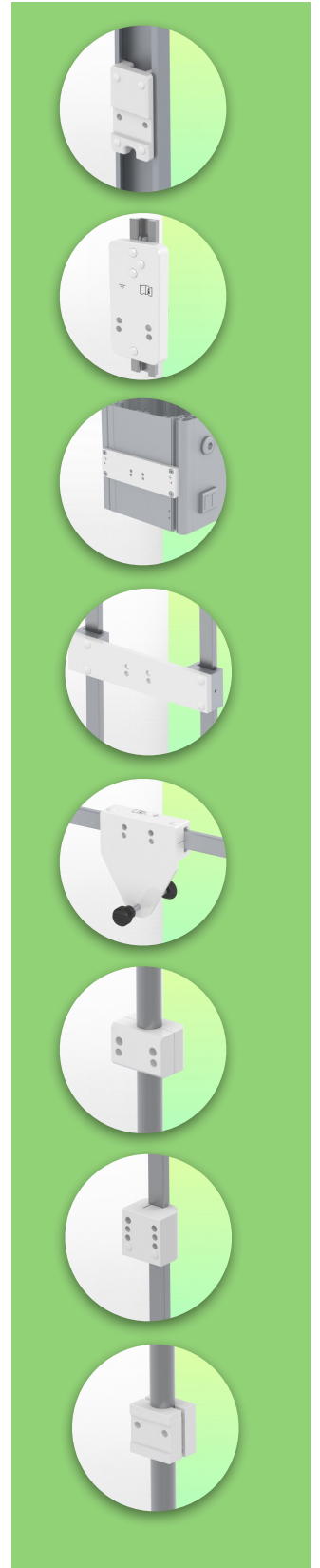
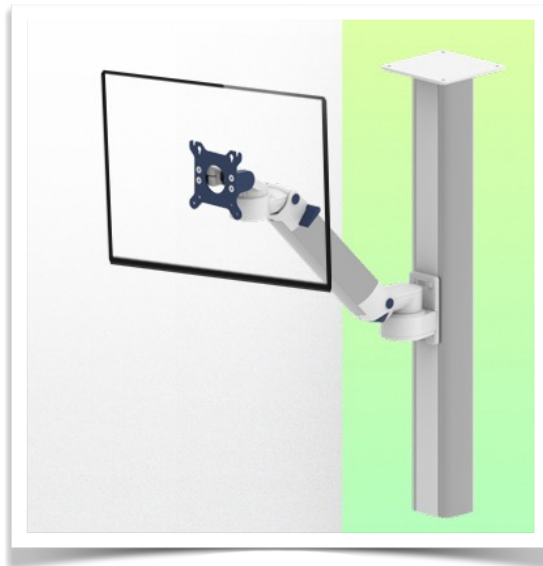

Considered to be the world's best in advanced hygiene control, our medical mounting systems include cable integration, a 5-year maintenance-free warranty and medical grade compliance. We're simply the best in the world at what we do.

**Compatible accessories for this mount**

**Part Number: WM 222.144CT**

**Height-adjustable medical arm, length 300 mm, table column mount.  
Supported weight balancing range from 16 to 22 Kg**

**Compatible accessories for this arm**

You can complete your installation with these additional accessories:



**Triple hook for cable** For mounting on support arm



**Double hook for cable** For mounting on support arm



**Downward pole with cable hook** For mounting on support arm

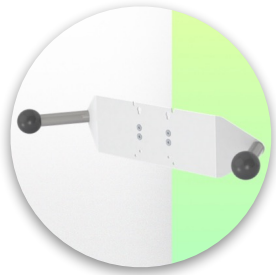

**Double handle with VESA mounting** For VESA monitors



**Handle for VESA monitor support** For VESA monitors



**Double hook for cable** For mounting on a wall or column rail



**Triple hook for cable** For wall or column rail mounting



**Basket** For wall or column rail mounting



**Downward Pole** For mounting on support arm

