

Presentation

Part Number: WM 222.192C

**Extended Height Adjustable Arm, floor or ceiling column mount.
Supported weight balancing range from 7,5 to 13 Kg**

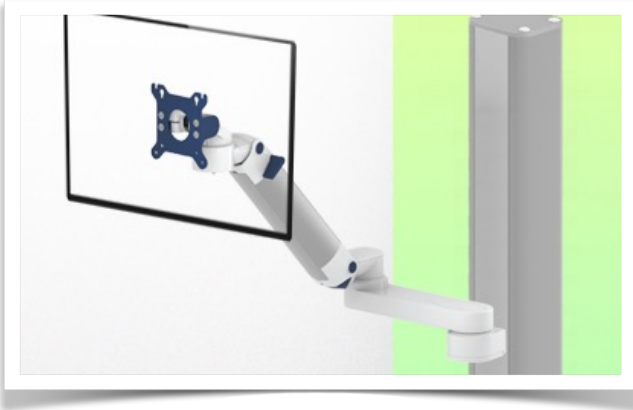

Cette colonne possède deux rails de fixation pour les différents éléments qui y seront fixés. (1 rail à l'avant de la colonne, 1 rail à l'arrière)

This column has two fixing rails for the different elements that will be fixed to it (1 rail at the front of the column, 1 rail at the back)

Deze zuil heeft twee bevestigingsrails voor de verschillende elementen die eraan bevestigd zullen worden (1 rail aan de voorkant van de zuil, 1 rail aan de achterkant)



**Extended Height Adjustable Arm, floor or ceiling column mount.
Supported weight balancing range from 7,5 to 13 Kg**

Full cable integration and infection control with easy-to-clean surfaces make this arm the ideal product for emergency care areas. Height adjustment for ergonomic and customized monitor positioning. This Extended Height Adjustable Arm with gas spring height adjustment allows the monitor to be perfectly fixed, oriented and adjusted. It is coated with an anti-microbial agent offering hygiene and cleaning in every detail. Its modern design has been specially designed for healthcare environments.

Technical specifications:

* Integrated cable entry * Equipotential bonding * Optional floor or ceiling columns are available in various heights (1500 - 2000 mm). These columns can be easily cut to size. All cables are also routed through the column.
(See Option on the following pages)

* This Extended Height Adjustable Arm with gas spring simply slides into the columnrail and then adjusts to the desired height and is fixed in place. It has a height adjustment safety stop button, which allows the arm to remain in the selected position. * The head of this arm complies with the VESA MIS-D 75 mm and 100 mm screen mounting standard.* Compatible with screens weighing no more than 7,5-13 Kg.* Touch screen stability. * Screen tilt: 30° down and 90° up * Screen rotation: 130° right, 180° left. * Arm rotation: 90° right, 90° left * Height adjustment: 45° down, 45° up * Total length 808 mm * All our medical arms are CE, ROHS, Medical Grade, Regulations MDD 93/42 ECC compliant. * Colour RAL 5013 cobalt blue and RAL 9016 traffic white * Warranty: 5 years

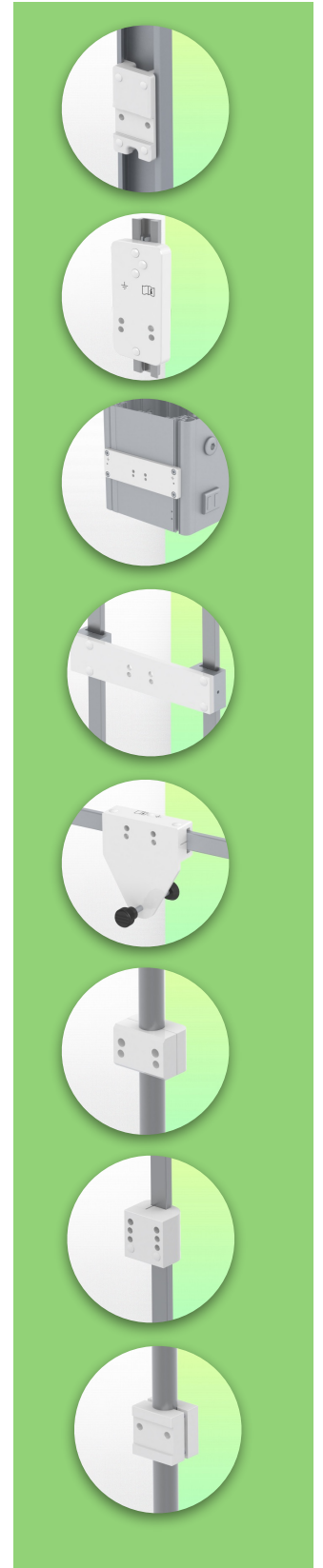

Technical Specifications

Part Number: WM 222.192C

**Extended Height Adjustable Arm, floor or ceiling column mount.
Supported weight balancing range from 7,5 to 13 Kg**

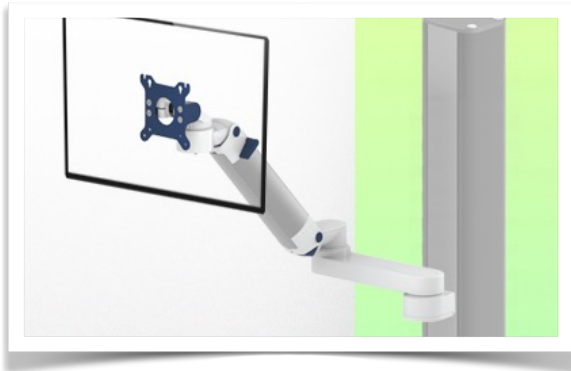

Cette colonne possède deux rails de fixation pour les différents éléments qui y seront fixés. (1 rail à l'avant de la colonne, 1 rail à l'arrière)

This column has two fixing rails for the different elements that will be fixed to it (1 rail at the front of the column, 1 rail at the back)

Deze zuil heeft twee bevestigingsrails voor de verschillende elementen die eraan bevestigd zullen worden (1 rail aan de voorkant van de zuil, 1 rail aan de achterkant)

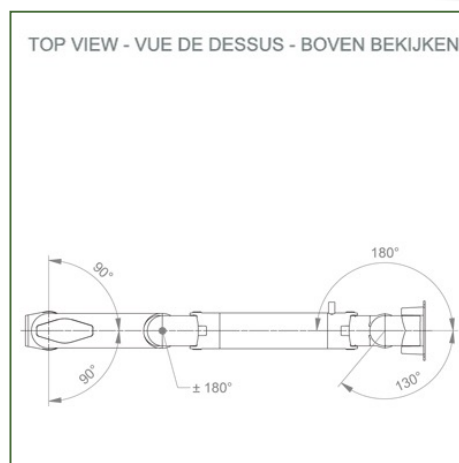
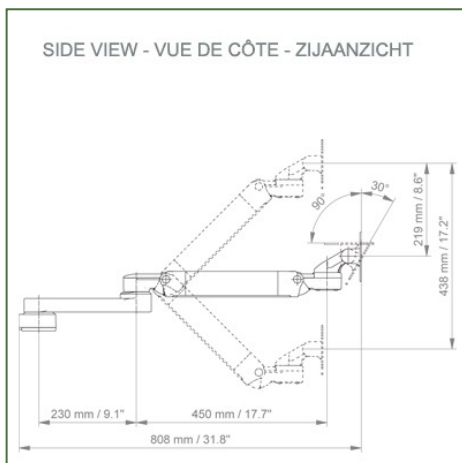
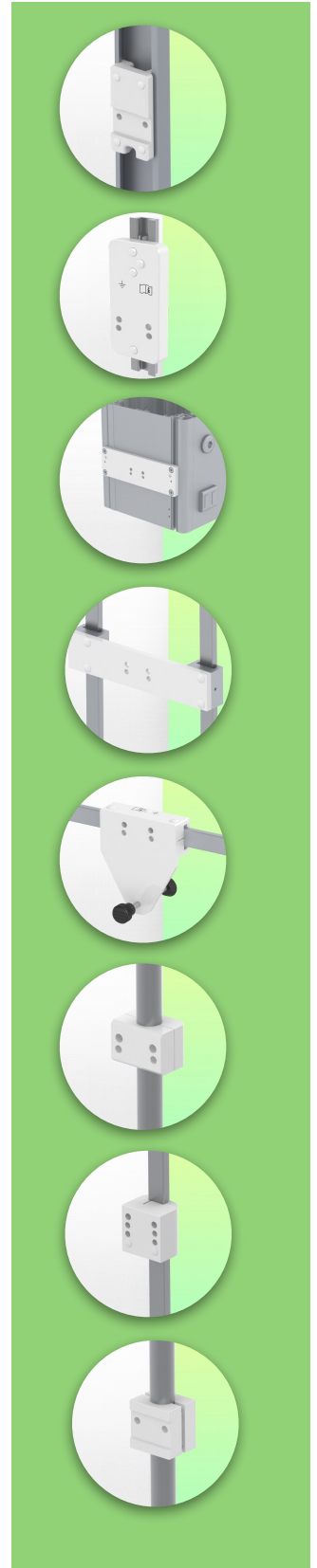
Monitor adaptation: VESA 75/100 mm
Colour: Decorative parts: RAL 5013 cobalt blue
 Aluminium parts: RAL 9016 traffic white
Balancing scale for this medical arm: 7,5 - 13 Kg
Product weight: 4,8 Kg
Height adjustment: Parallel mechanism for a constant viewing angle
Safety: Has a safety stop button for the height adjustment, which allows the medical arm to remain in the chosen position.



Mounting Information - Wall Slide Rail

Part Number: WM 222.192C

**Extended Height Adjustable Arm, floor or ceiling column mount.
Supported weight balancing range from 7,5 to 13 Kg**

Floor or ceiling column:

To install this medical arm, you need to use one of our medical columns. These are available in standard heights of 1500 and 2000 mm. Custom heights are available on request. Slide covers and end caps are supplied with every order.

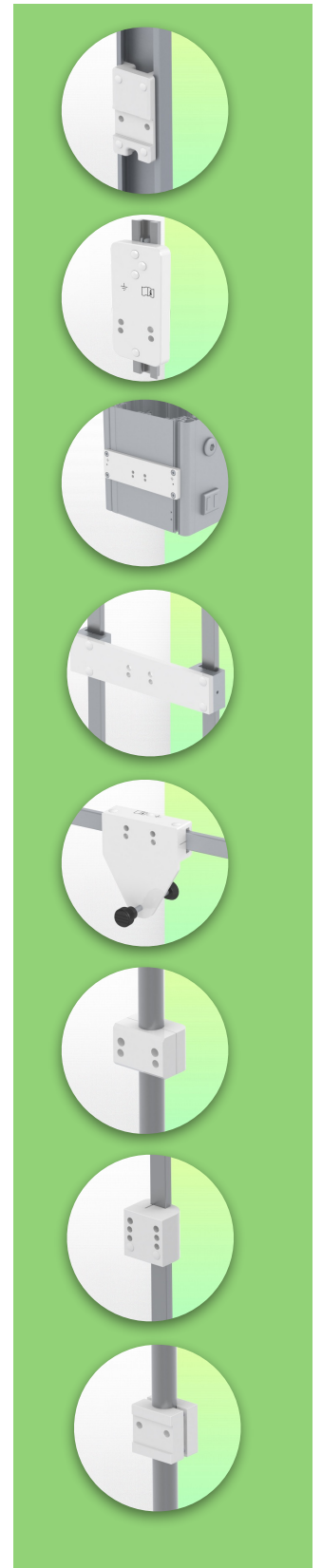
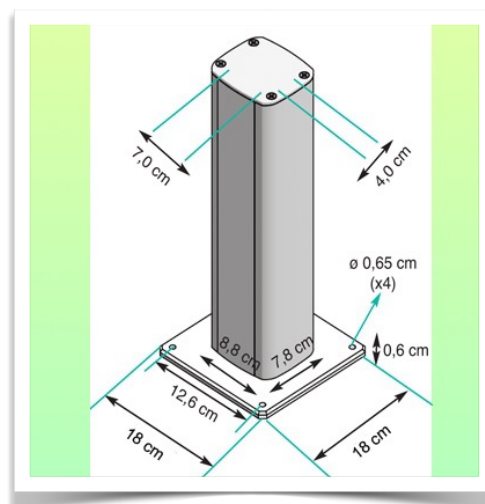
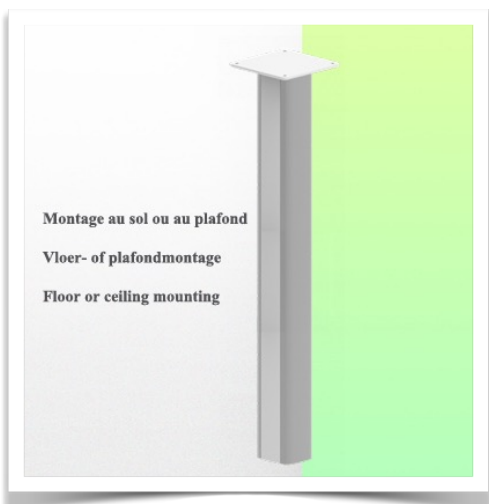
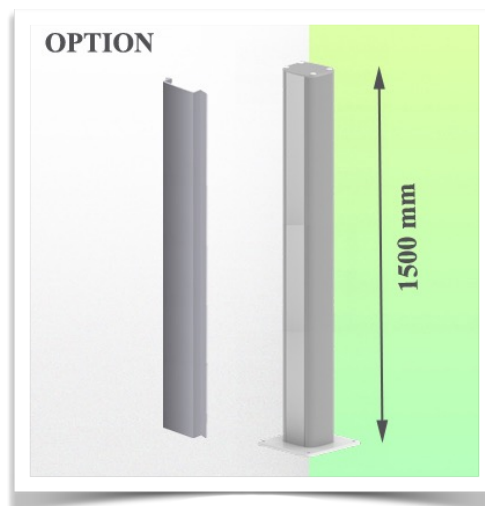
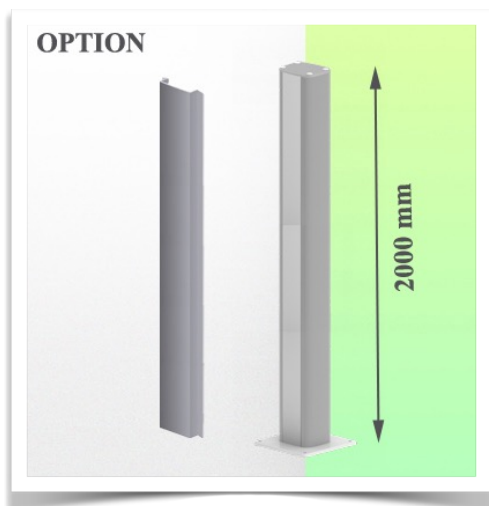

Mounting information - Mounting options

Part Number: WM 222.192C

**Extended Height Adjustable Arm, floor or ceiling column mount.
Supported weight balancing range from 7,5 to 13 Kg**

Where do you want to mount the support arm?

At the hospital, there are different ways to fix our brackets: round tube, standard rail, wall rail or on an anaesthesia machine. We will always provide you with the adapter you need.



Adapter for vertical wall slide
For wall slide mounting



Adapter for Amico remote controls and wall panels

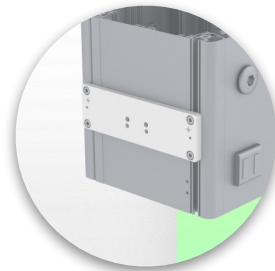

Adapter for Mindray medical power supply units



Double clamp for vertical standard rail
For mounting on two parallel vertical standard rails 10 x 25 mm

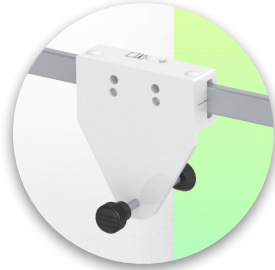

Fixed clamp for a standard rail
For mounting on a horizontal standard rail 10 x 25, 8 x 35, 10 x 30, 10 x 50 mm

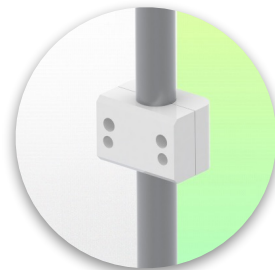

Fixed clamp for round tube
For mounting on round tube \varnothing 25, 35, 38 mm



Adapter for Maquet anaesthesia machines
Cone Adapter for Model FLOW i



Adapter for Löwenstein anaesthesia machines
Medical Adapter for Leon / Leon plus

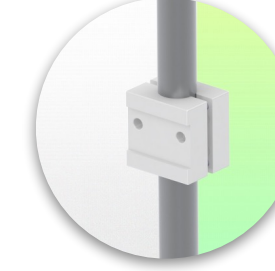

Universal round tube clamp
V-clamp for mounting on round tube \varnothing 23 - 40 mm

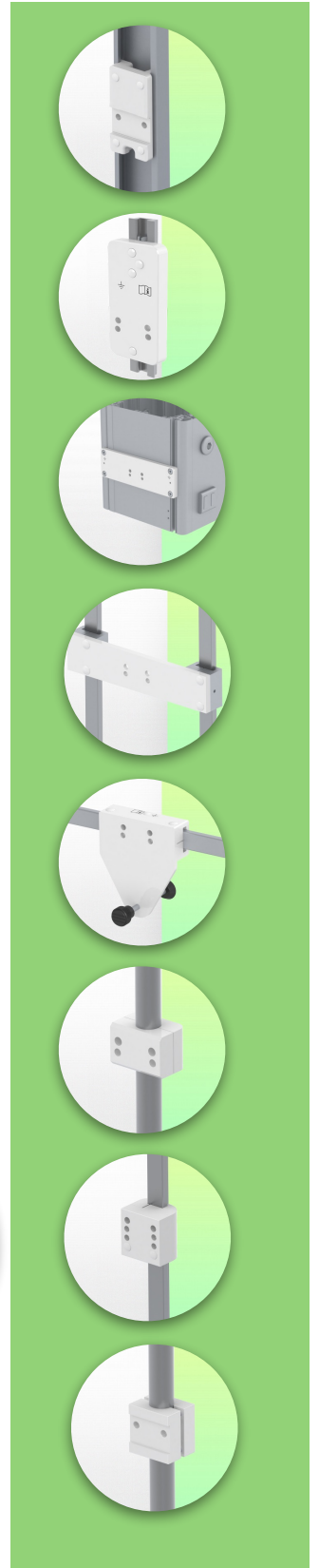

Mounting information - Mounting options

Part Number: WM 222.192C

**Extended Height Adjustable Arm, floor or ceiling column mount.
Supported weight balancing range from 7,5 to 13 Kg**

Where do you want to mount the support arm?

At the hospital, there are different ways to fix our brackets: round tube, standard rail, wall rail or on an anaesthesia machine. We will always provide you with the adapter you need.

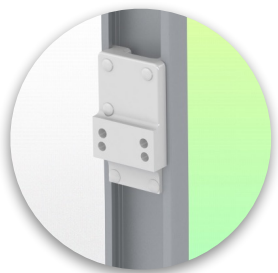

Adapter for anaesthesia machine (all suppliers)
H 80 mm, with existing side rail

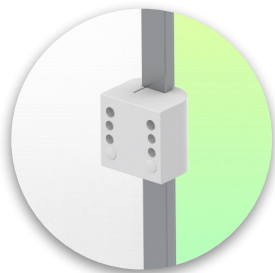

Clamp for a vertical standard rail
For mounting on standard rail 10 x 25 mm



Floor or ceiling column
1500 mm or 2000 mm

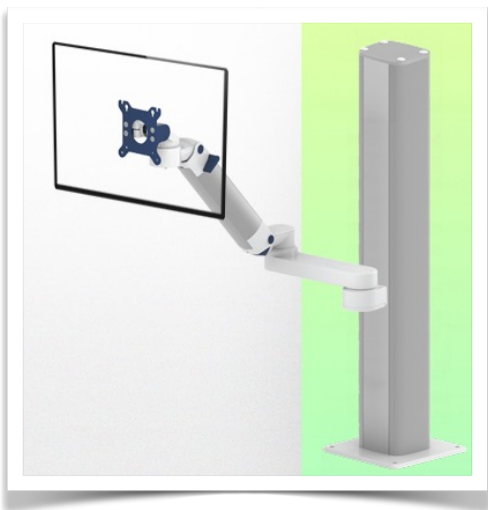

Considered to be the world's best in advanced hygiene control, our medical mounting systems include cable integration, a 5-year maintenance-free warranty and medical grade compliance. We're simply the best in the world at what we do.

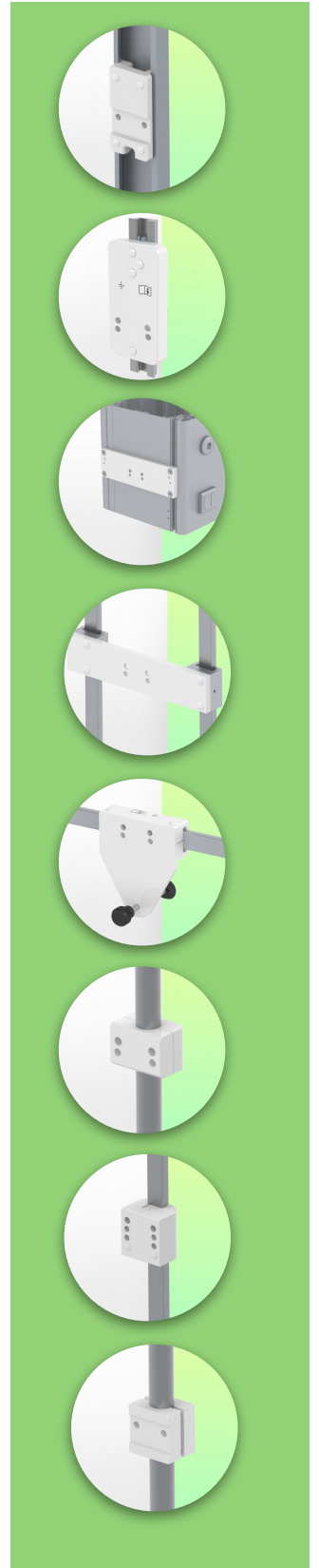

Compatible accessories for this mount

Part Number: WM 222.192C

Extended Height Adjustable Arm, floor or ceiling column mount, Supported weight balancing range from 7,5 to 13 Kg

Compatible accessories for this medical arm

You can complete your installation with these additional accessories:



Triple hook for cable For mounting on support arm



Double hook for cable For mounting on support arm



Downward pole with cable hook For mounting on support arm

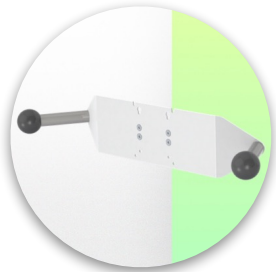

Double handle with VESA mounting For VESA monitors



Handle for VESA monitor support For VESA monitors

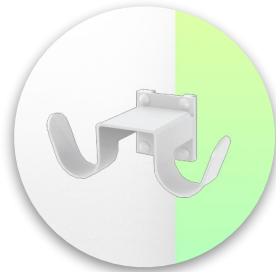

Double hook for cable For mounting on a wall or column rail



Triple hook for cable For wall or column rail mounting



Basket For wall or column rail mounting



Downward Pole For mounting on support arm

