

Presentation

Part Number: WM 222.230

Extended Height Adjustable Arm, Mounting on Amico medical device pendants and headwalls. Supported weight balancing range from 2 to 5 Kg



Extended Height Adjustable Arm, Mounting on Amico medical device pendants and headwalls. Supported weight balancing range from 2 to 5 Kg

Perfect for maximum reach to the work area and allowing the height to be adjusted to suit individual ergonomic requirements. It folds down to its mounting point for easy storage when not in use. Range of motion from fully retracted to full extension. Integrated cable management. Smooth continuous surfaces with minimal joints for easy cleaning and infection prevention. Maintenance-free operation during the 5-year warranty. Smooth movement and easy handling.

Technical specifications:

- * Integrated cable passage * Equipotential bonding
- * Fixing on the chosen adapter solution
- * This Horizontal extended Arm with gas spring simply adjusts to the desired height and is fixed. * It has a safety stop button for height adjustment, which allows the arm to remain in the chosen position. * The head of this arm complies with the VESA 75/100 mm screen mounting standard.
- * Compatible with screens weighing no more than 2-5 Kg. * Stability touch screen.
- * Screen tilt: 30° down and 90° up. Screen rotation: 130° right, 180° left.
- * Arm rotation: 90° right, 90° left. * Height adjustment: 45° down, 45° up
- * Total length 808 mm
- * All our medical arms are CE, ROHS, Medical Grade, Regulations MDD 93/42 ECC compliant.
- * Colour RAL 5013 cobalt blue and RAL 9016 traffic white
- * Warranty: 5 years

Technical Specifications

Part Number: WM 222.230

Extended Height Adjustable Arm, Mounting on Amico medical device pendants and headwalls. Supported weight balancing range from 2 to 5 Kg

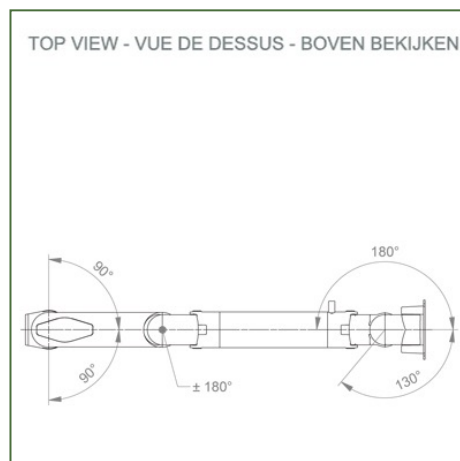
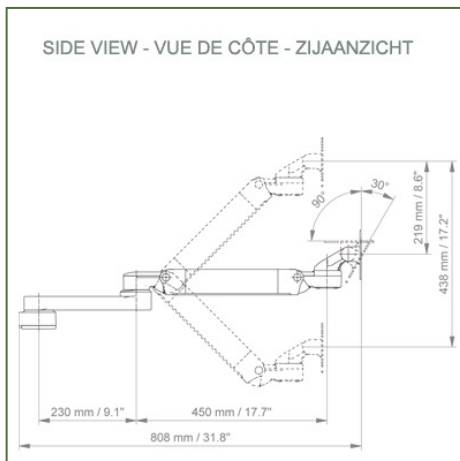
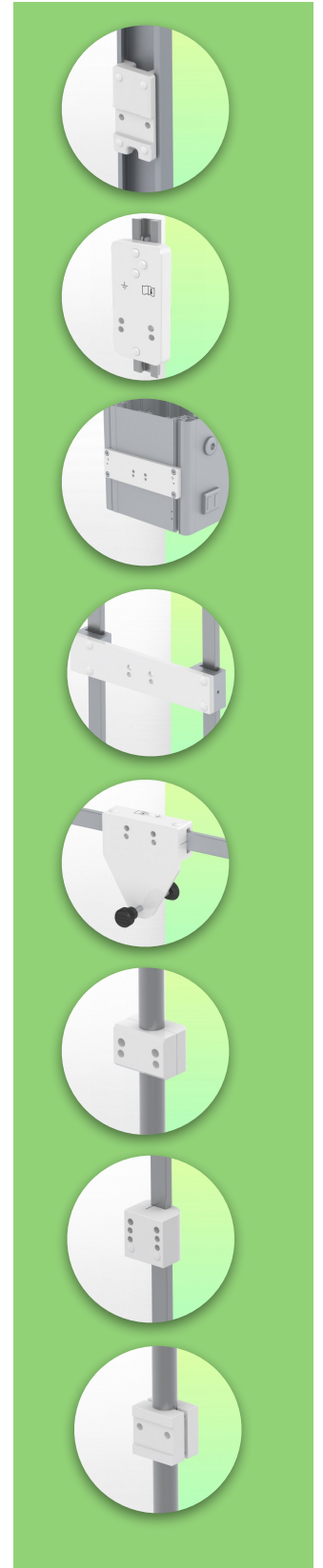
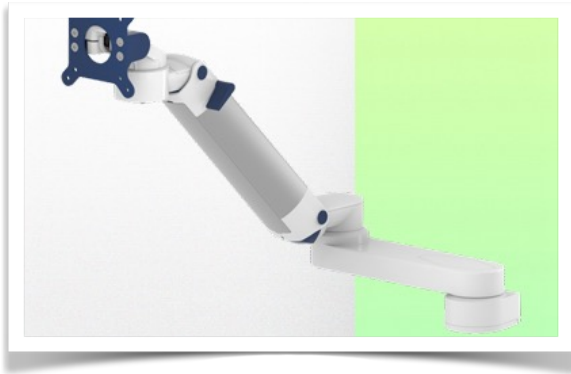

Monitor adaptation: VESA 75/100 mm

Colour: Decorative parts: RAL 5013 cobalt blue

Aluminium parts: RAL 9016 traffic white

Max. load capacity of the support arm: 22 kg

Max. load capacity of the monitor: 18 Kg

Monitor adaptation max. load: 18 Kg

Balancing scale for this medical arm: 2 - 5 Kg

Product weight: 4,8 Kg

Height adjustment: Parallel mechanism for a constant viewing angle
Safety: Has a safety stop button for the height adjustment, which allows the medical arm to remain in the chosen position.



Mounting Information - Adapter Amico

Part Number: WM 222.230

Extended Height Adjustable Arm, Mounting on Amico medical device pendants and headwalls. Supported weight balancing range from 2 to 5 Kg

Adapter Amico:

Mounting on Amico medical device pendants and headwalls



Mounting information - Mounting options

Part Number: WM 222.230

Extended Height Adjustable Arm, Mounting on Amico medical device pendants and headwalls. Supported weight balancing range from 2 to 5 Kg

Where do you want to mount the support arm?

At the hospital, there are different ways to fix our brackets: round tube, standard rail, wall rail or on an anaesthesia machine. We will always provide you with the adapter you need.



Adapter for vertical wall slide
For wall slide mounting



Adapter for Amico remote controls and wall panels



Adapter for Mindray medical power supply units



Double clamp for vertical standard rail
For mounting on two parallel vertical standard rails 10 x 25 mm



Fixed clamp for a standard rail
For mounting on a horizontal standard rail 10 x 25, 8 x 35, 10 x 30, 10 x 50 mm



Fixed clamp for round tube
For mounting on round tube \varnothing 25, 35, 38 mm



Adapter for Maquet anaesthesia machines
Cone Adapter for Model FLOW i



Adapter for Löwenstein anaesthesia machines
Medical Adapter for Leon / Leon plus

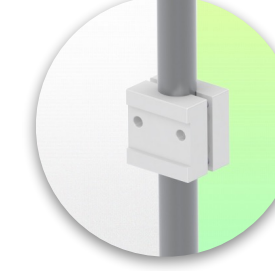

Universal round tube clamp
V-clamp for mounting on round tube \varnothing 23 - 40 mm

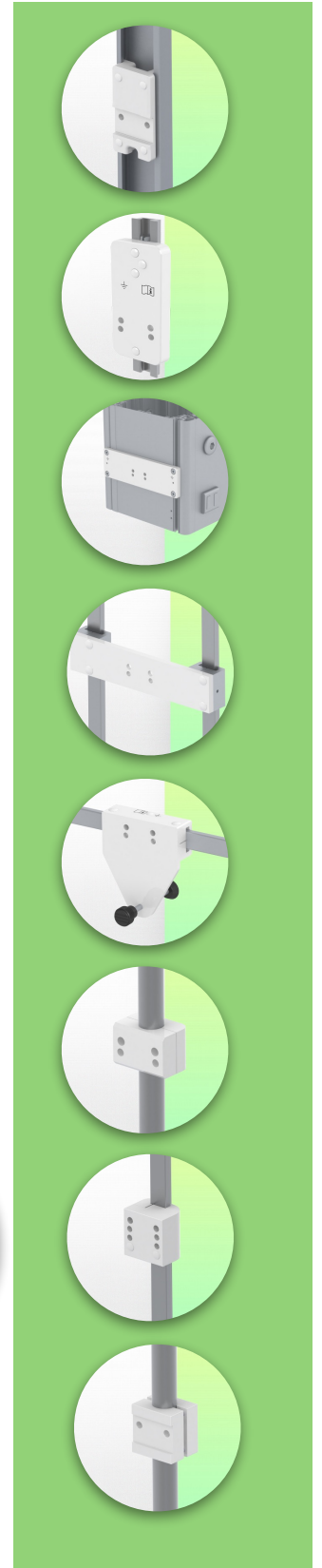

Mounting information - Mounting options

Part Number: WM 222.230

Extended Height Adjustable Arm, Mounting on Amico medical device pendants and headwalls. Supported weight balancing range from 2 to 5 Kg

Where do you want to mount the support arm?

At the hospital, there are different ways to fix our brackets: round tube, standard rail, wall rail or on an anaesthesia machine. We will always provide you with the adapter you need.



Adapter for anaesthesia machine (all suppliers)

H 80 mm, with existing side rail



Clamp for a vertical standard rail

For mounting on standard rail 10 x 25 mm



Considered to be the world's best in advanced hygiene control, our medical mounting systems include cable integration, a 5-year maintenance-free warranty and medical grade compliance. We're simply the best in the world at what we do.



Compatible accessories for this mount

Part Number: WM 222.230

Extended Height Adjustable Arm, Mounting on Amico medical device pendants and headwalls. Supported weight balancing range from 2 to 5 Kg

Compatible accessories for this Medical Arm

You can complete your installation with these additional accessories:



Triple hook for cable
For mounting on support arm



Double hook for cable
For mounting on support arm



Downward pole with cable hook
For mounting on support arm

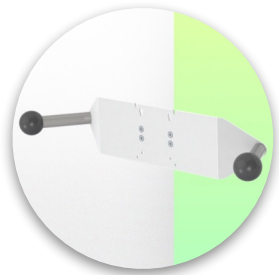

Double handle with VESA mounting
For VESA monitors



Handle for VESA monitor support
For VESA monitors



Double hook for cable
For wall or column rail mounting



Triple hook for cable
For wall or column rail mounting



Basket
For wall or column rail mounting



Downward Pole
For mounting on support arm

