

**Presentation**

**Part Number: WM 222.282**

**Height-adjustable medical arm, length 300 mm, Mounting on Amico medical device pendants and headwalls. Supported weight balancing range from 7,5 to 13 Kg. Overhead mount**

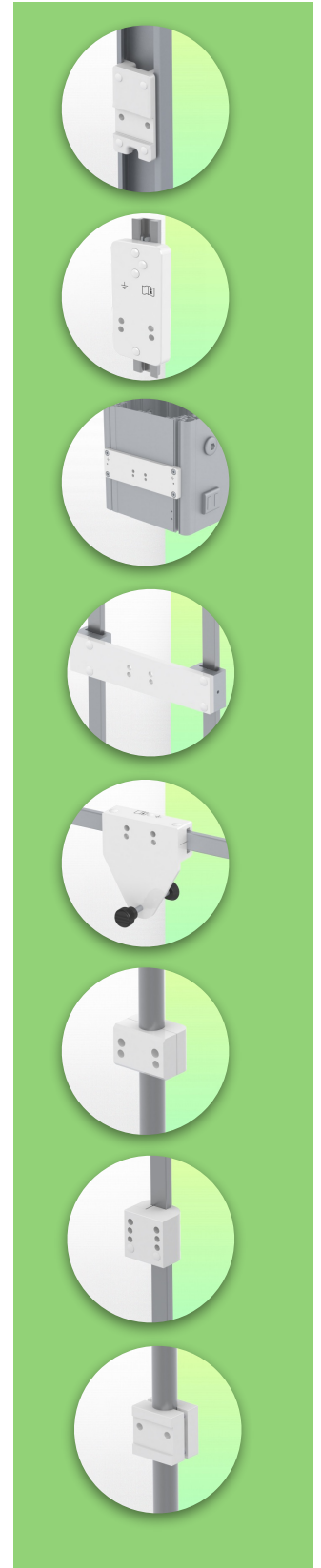
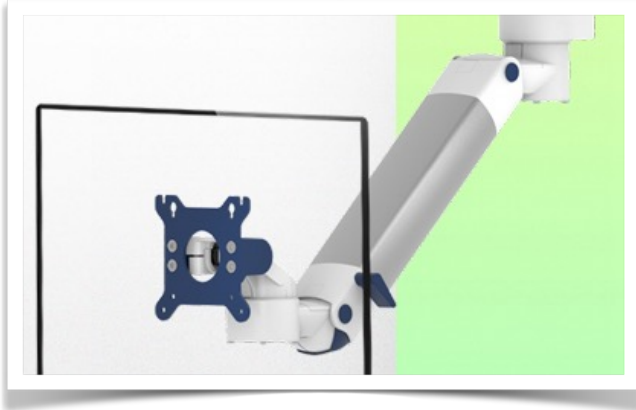

**Height-adjustable medical arm, length 300 mm, Mounting on Amico medical device pendants and headwalls. Supported weight balancing range from 7,5 to 13 Kg. Overhead mount**

Designed to gain those crucial few centimeters in its lowest position, when the only available mounting point is high up. The arm descends from the first joint and can be adjusted in height for ergonomic ease. Ideal when the only available mounting position is out of reach. Perfect for attachment to pendants, booms and horizontal rails that are mounted above supply ducts.

**Technical specifications:**

- \* Integrated cable passage
- \* Equipotential bonding
- \* Fixing on the chosen adapter solution
- \* This 300 mm Horizontal Arm with gas spring simply adjusts to the desired height and is fixed.
- \* It has a safety stop button for height adjustment, which allows the arm to remain in the chosen position.
- \* The head of this arm complies with the VESA 75/100 mm screen mounting standard.
- \* Compatible with screens weighing no more than 7,5-13 Kg.
- \* Stability touch screen.
- \* Screen tilt: 30° down and 90° up. Screen rotation: 130° right, 180° left.
- \* Arm rotation: 90° right, 90° left.
- \* Height adjustment: 45° down, 45° up
- \* Total length 578 mm
- \* All our medical arms are CE, ROHS, Medical Grade, Regulations MDD 93/42 ECC compliant.
- \* Colour RAL 5013 cobalt blue and RAL 9016 traffic white
- \* Warranty: 5 years

## Technical Specifications

Part Number: WM 222.282

Height-adjustable medical arm, length 300 mm, Mounting on Amico medical device pendants and headwalls. Supported weight balancing range from 7,5 to 13 Kg. Overhead mount

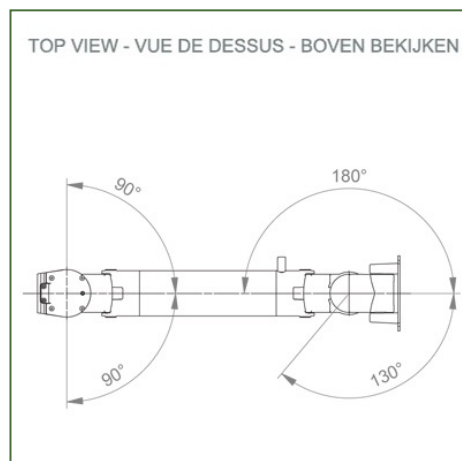
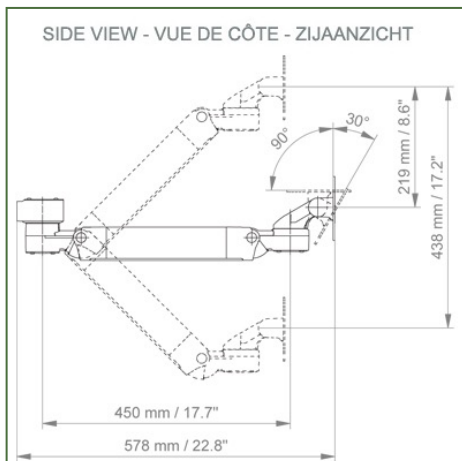
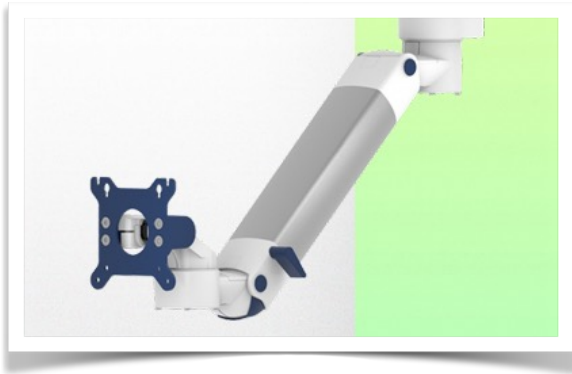

**Monitor adaptation:** VESA 75/100 mm

**Colour:** Decorative parts: RAL 5013 cobalt blue

**Aluminium parts:** RAL 9016 traffic white

**Max. load capacity of the support arm:** 22 kg

**Max. load capacity of the monitor:** 18 Kg

**Monitor adaptation max. load:** 18 Kg

**Balancing scale for this medical arm:** 7,5 - 13 Kg

**Product weight:** 5,2 Kg

**Height adjustment:** Parallel mechanism for a constant viewing angle  
**Safety:** Has a safety stop button for the height adjustment, which allows the medical arm to remain in the chosen position.

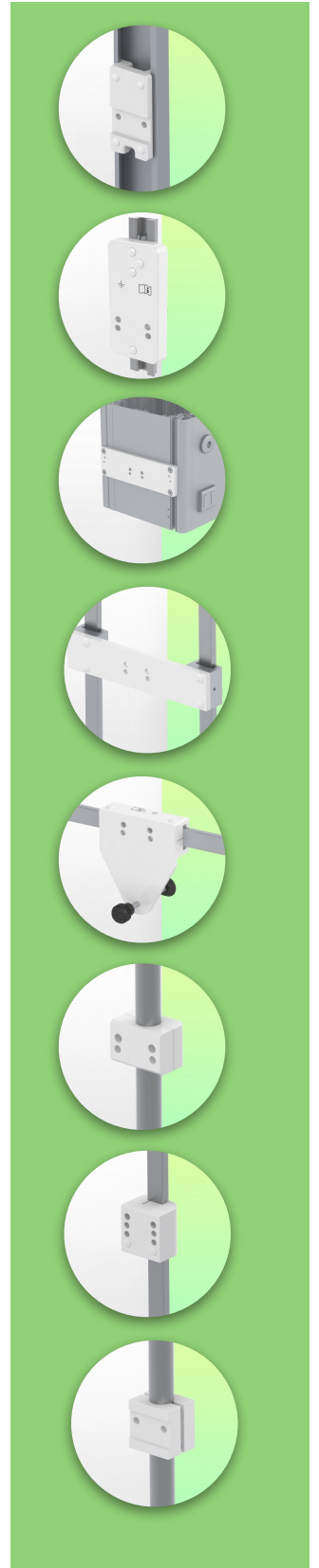

**Mounting Information - Adapter Amico**

**Part Number: WM 222.282**

**Height-adjustable medical arm, length 300 mm, Mounting on Amico medical device pendants and headwalls. Supported weight balancing range from 7,5 to 13 Kg. Overhead mount**

**Adapter Amico:**

Mounting on Amico medical device pendants and headwalls

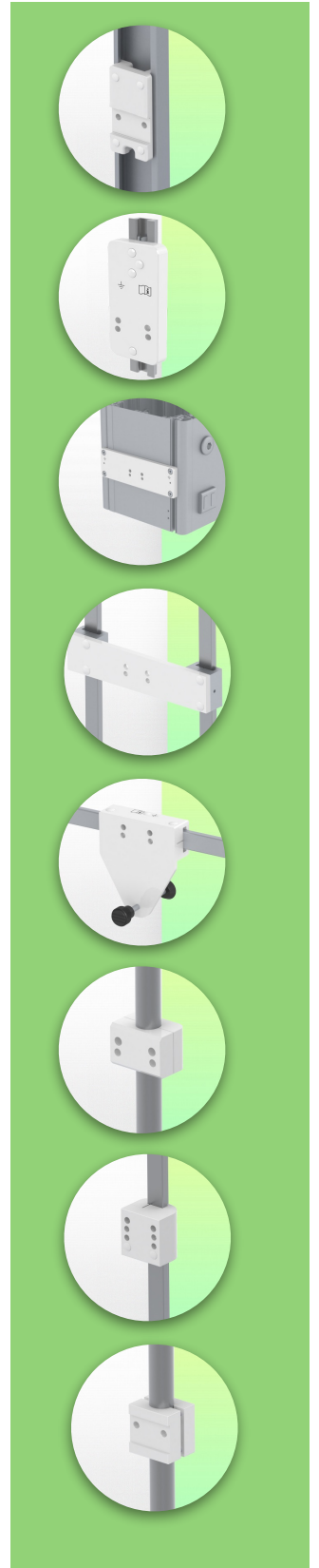

**Mounting information - Mounting options**

**Part Number: WM 222.282**

**Height-adjustable medical arm, length 300 mm, Mounting on Amico medical device pendants and headwalls. Supported weight balancing range from 7,5 to 13 Kg. Overhead mount**

**Where do you want to mount the support arm?**

At the hospital, there are different ways to fix our brackets: round tube, standard rail, wall rail or on an anaesthesia machine. We will always provide you with the adapter you need.

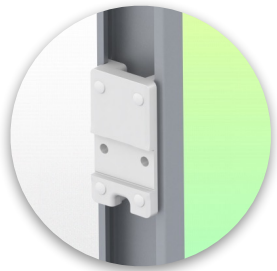

**Adapter for vertical wall slide**  
For wall slide mounting



**Adapter for Amico remote controls and wall panels**

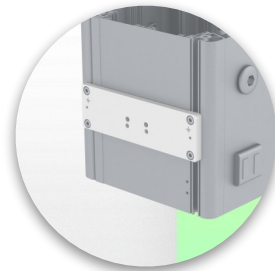

**Adapter for Mindray medical power supply units**



**Double clamp for vertical standard rail**  
For mounting on two parallel vertical standard rails 10 x 25 mm

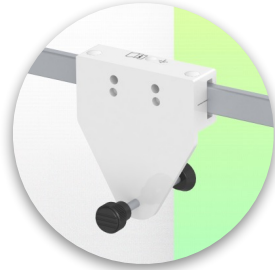

**Fixed clamp for a standard rail**  
For mounting on a horizontal standard rail 10 x 25, 8 x 35, 10 x 30, 10 x 50 mm

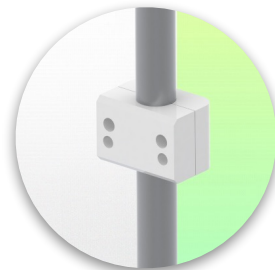

**Fixed clamp for round tube**  
For mounting on round tube  $\varnothing$  25, 35, 38 mm



**Adapter for Maquet anaesthesia machines**  
Cone Adapter for Model FLOW i



**Adapter for Löwenstein anaesthesia machines**  
Medical Adapter for Leon / Leon plus

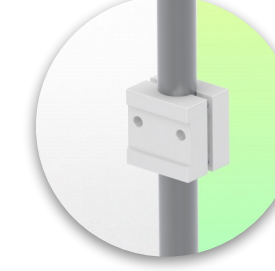

**Universal round tube clamp**  
V-clamp for mounting on round tube  $\varnothing$  23 - 40 mm

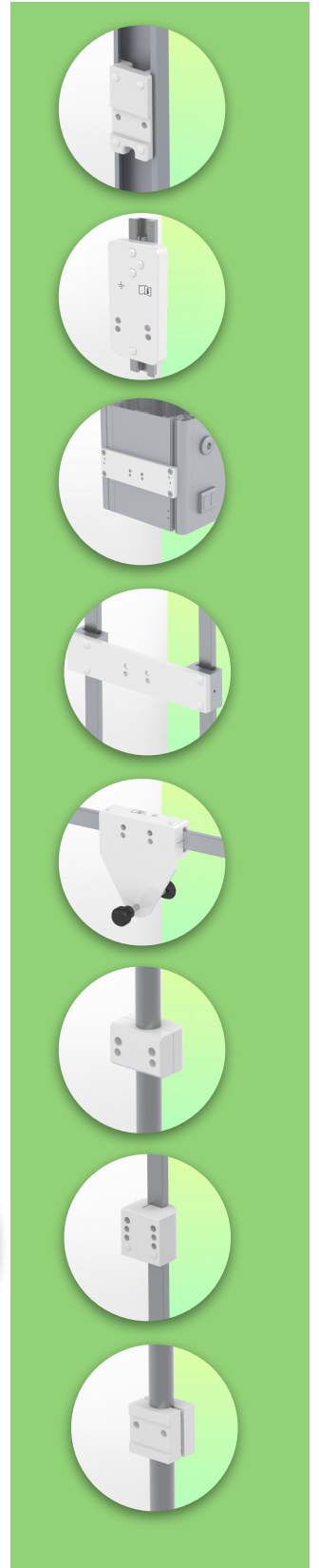

**Mounting information - Mounting options**

**Part Number: WM 222.282**

**Height-adjustable medical arm, length 300 mm, Mounting on Amico medical device pendants and headwalls. Supported weight balancing range from 7,5 to 13 Kg. Overhead mount**

**Where do you want to mount the support arm?**

At the hospital, there are different ways to fix our brackets: round tube, standard rail, wall rail or on an anaesthesia machine. We will always provide you with the adapter you need.

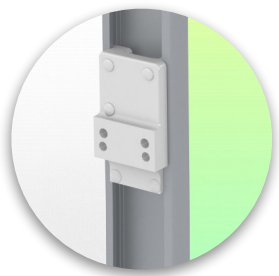

**Adapter for anaesthesia machine (all suppliers)**

H 80 mm, with existing side rail

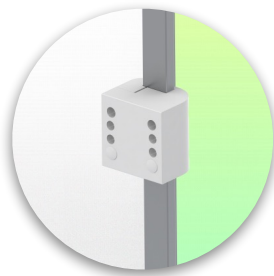

**Clamp for a vertical standard rail**

For mounting on standard rail 10 x 25 mm



Considered to be the world's best in advanced hygiene control, our medical mounting systems include cable integration, a 5-year maintenance-free warranty and medical grade compliance. We're simply the best in the world at what we do.

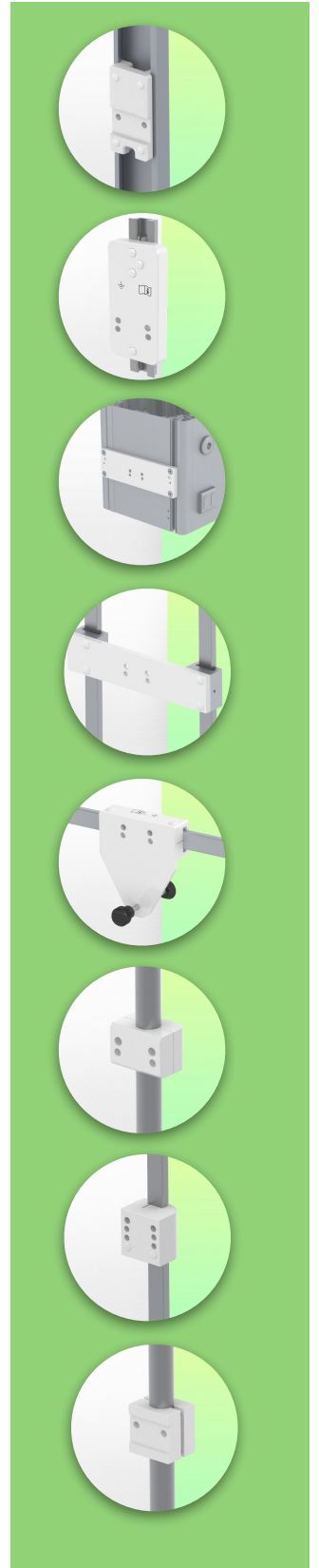

**Compatible accessories for this mount**

**Part Number: WM 222.282**

**Height-adjustable medical arm, length 300 mm, Mounting on Amico medical device pendants and headwalls. Supported weight balancing range from 7,5 to 13 Kg. Overhead mount**

**Compatible accessories for this Medical Arm**

You can complete your installation with these additional accessories:



**Triple hook for cable**  
For mounting on support arm



**Double hook for cable**  
For mounting on support arm



**Downward pole with cable hook**  
For mounting on support arm

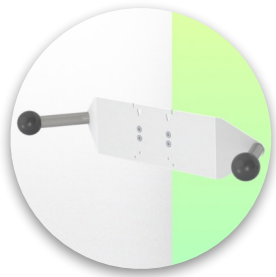

**Double handle with VESA mounting**  
For VESA monitors



**Handle for VESA monitor support**  
For VESA monitors



**Double hook for cable**  
For wall or column rail mounting



**Triple hook for cable**  
For wall or column rail mounting



**Basket**  
For wall or column rail mounting



**Downward Pole**  
For mounting on support arm

