

Presentation

Part Number: WM 222.291CT

Extended Height Adjustable Arm, table column mount.

Supported weight balancing range from 4 to 9 Kg. Overhead mount

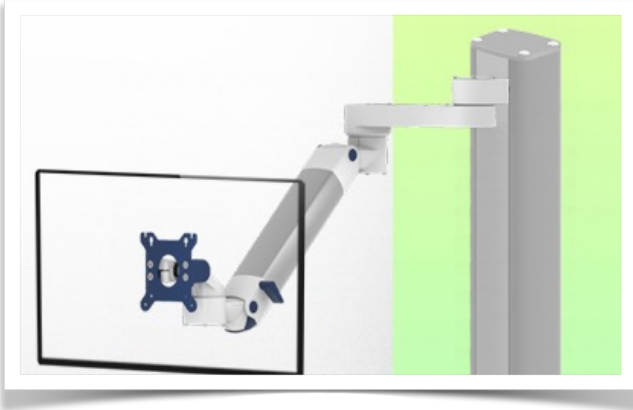

Cette colonne possède deux rails de fixation pour les différents éléments qui y seront fixés.
1 rail à l'avant de la colonne,
1 rail à l'arrière

Deze kolom heeft twee bevestigings rails voor de verschillende elementen die eraan zullen worden bevestigd.
1 rail aan de voorkant van de kolom,
1 rail aan de achterkant

This column has two fixing rails for the various elements that will be fixed to it. 1 rail at the front of the column, 1 rail at the back)

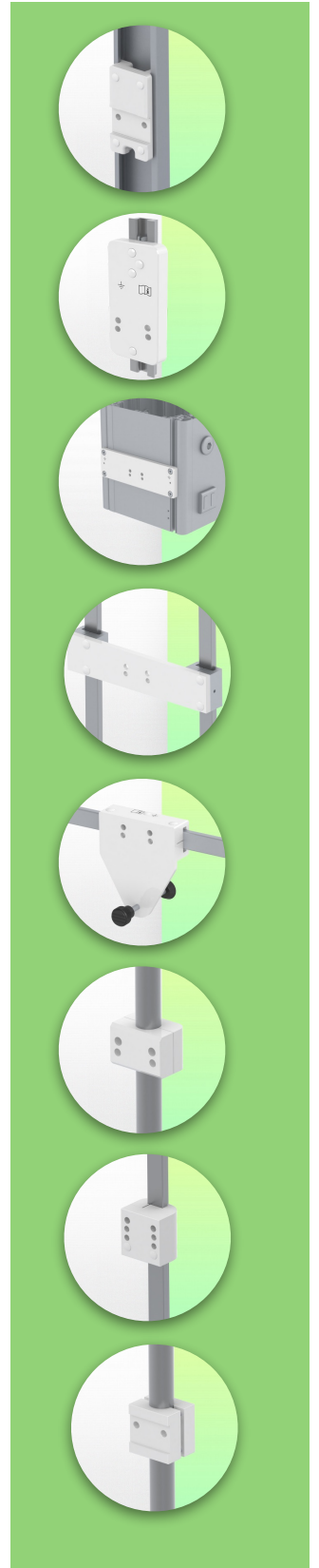
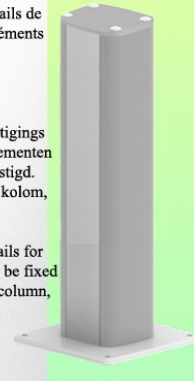

Extended Height Adjustable Arm, table column mount.

Supported weight balancing range from 4 to 9 Kg. Overhead mount

When the only available mounting point is high up, this arm gains those crucial extra centimeters lower for ergonomic ease. The Arm extends far in to working space, height adjusts and can be folded back neatly when not use. You need extended reach for your monitor? And the only available mounting position is too high to reach your device? This arm was especially designed for high mounting positions. The arm steps down from the first and second joint. Cable integration offers a neat and clean working environment. A medical-grade arm with easy-to-clean and infection control friendly surfaces, a 5-year warranty and a 6-fold safety factor.

Technical specifications:

* Integrated cable entry * Equipotential bonding * Optional table columns are available in various heights (500 - 300 mm). These columns can be easily cut to size. All cables are also routed through the column. (See Option on the following pages) * This Extended Height Adjustable Arm with gas spring simply slides into the column rail and then adjusts to the desired height and is fixed in place. It has a height adjustment safety stop button, which allows the arm to remain in the selected position. * The head of this arm complies with the VESA MIS-D 75 mm and 100 mm screen mounting standard.* Compatible with screens weighing no more than 4-9 Kg.* Touch screen stability. * Screen tilt: 30° down and 90° up * Screen rotation: 130° right, 180° left. * Arm rotation: 90° right, 90° left * Height adjustment: 45° down, 45° up * Total length 808 mm * All our medical arms are CE, ROHS, Medical Grade, Regulations MDD 93/42 ECC compliant. * Colour RAL 5013 cobalt blue and RAL 9016 traffic white * Warranty: 5 years

Technical Specifications

Part Number: WM 222.291CT

Extended Height Adjustable Arm, table column mount.

Supported weight balancing range from 4 to 9 Kg. Overhead mount

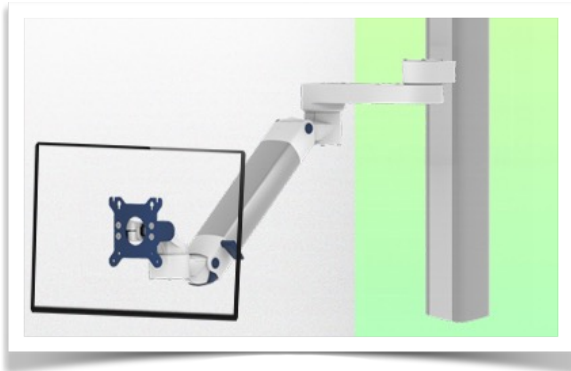

Cette colonne possède deux rails de fixation pour les différents éléments qui y seront fixés.

1 rail à l'avant de la colonne,
1 rail à l'arrière

Deze kolom heeft twee bevestigings rails voor de verschillende elementen die eraan zullen worden bevestigd.

1 rail aan de voorkant van de kolom,
1 rail aan de achterkant

This column has two fixing rails for the various elements that will be fixed to it. 1 rail at the front of the column, 1 rail at the back)

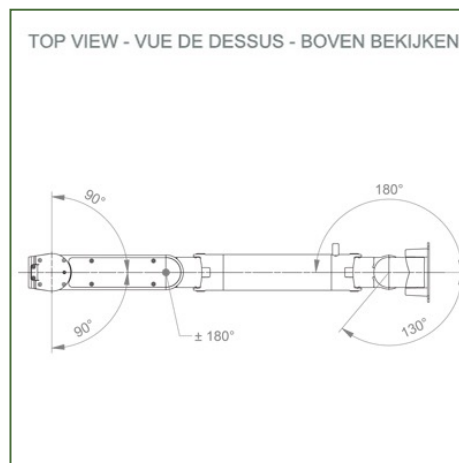
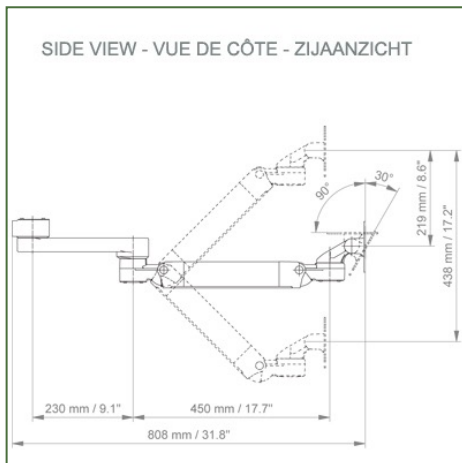
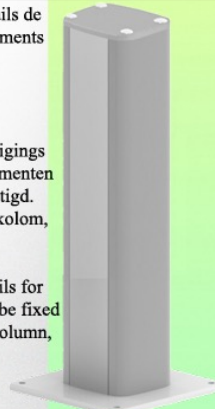

Monitor adaptation: VESA 75/100 mm

Colour: Decorative parts: RAL 5013 cobalt blue

Aluminium parts: RAL 9016 traffic white

Balancing scale for this medical arm: 4 - 9 Kg

Product weight: 5,2 Kg

Height adjustment: Parallel mechanism for a constant viewing angle
Safety: Has a safety stop button for the height adjustment, which allows the medical arm to remain in the chosen position.

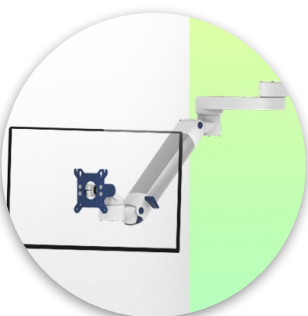

Mounting Information - Wall Slide Rail

Part Number: WM 222.291CT

Extended Height Adjustable Arm, table column mount.

Supported weight balancing range from 4 to 9 Kg. Overhead mount

Table column:

To install this medical arm, you need to use one of our medical columns. These are available in standard heights of 500 and 300 mm. Custom heights are available on request. Slide covers and end caps are supplied with every order.

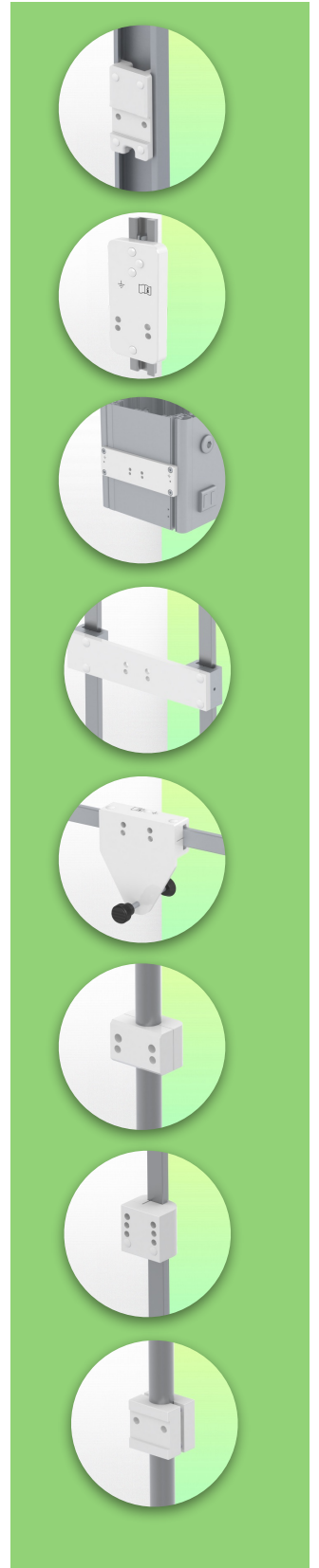
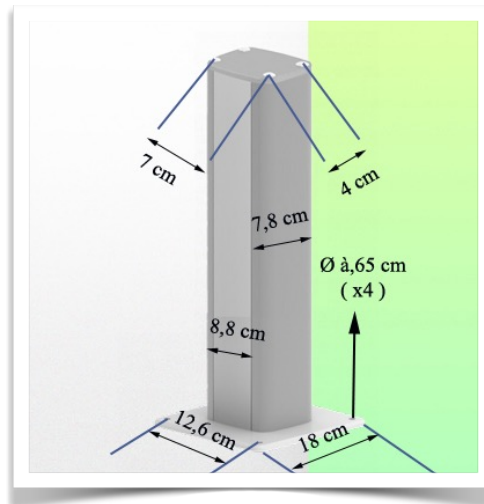
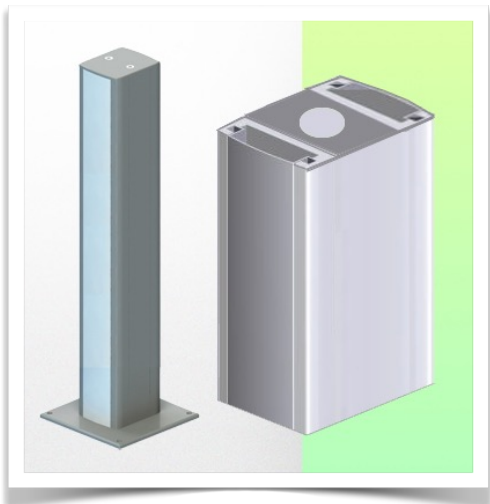
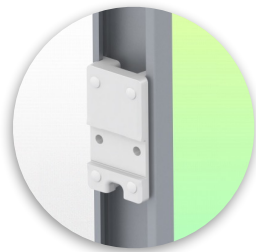
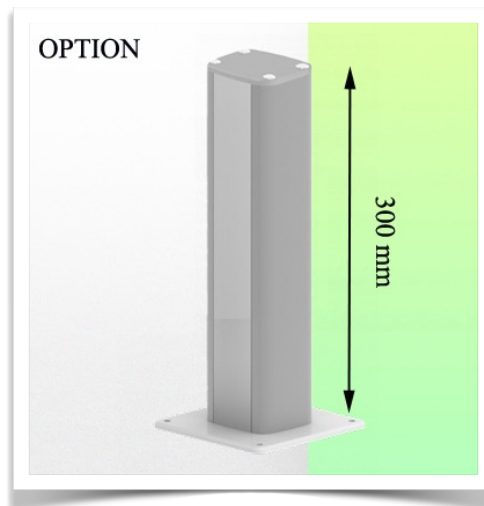
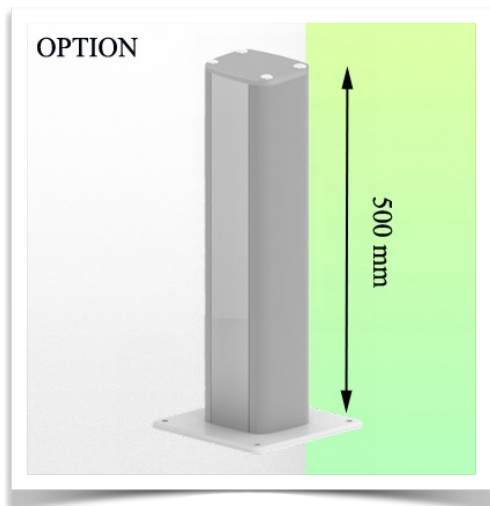

Mounting information - Mounting options

Part Number: WM 222.291CT

Extended Height Adjustable Arm, table column mount.

Supported weight balancing range from 4 to 9 Kg. Overhead mount

Where do you want to mount the support arm?

At the hospital, there are different ways to fix our brackets: round tube, standard rail, wall rail or on an anaesthesia machine. We will always provide you with the adapter you need.

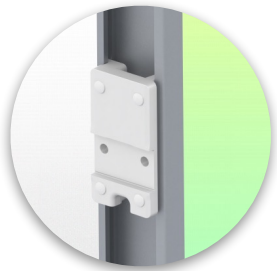

Adapter for vertical wall slide
For wall slide mounting



Adapter for Amico remote controls and wall panels

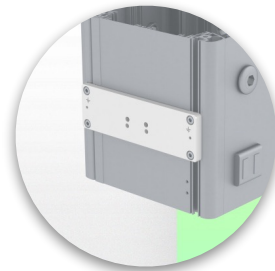

Adapter for Mindray medical power supply units



Double clamp for vertical standard rail
For mounting on two parallel vertical standard rails 10 x 25 mm

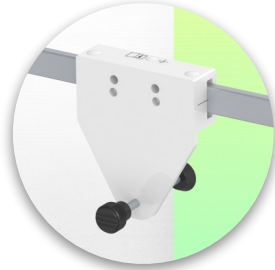

Fixed clamp for a standard rail
For mounting on a horizontal standard rail 10 x 25, 8 x 35, 10 x 30, 10 x 50 mm

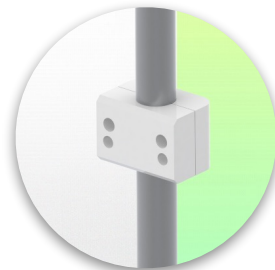

Fixed clamp for round tube
For mounting on round tube \varnothing 25, 35, 38 mm

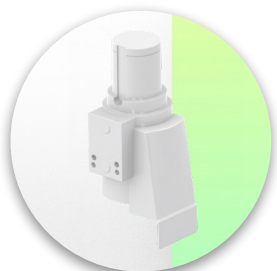

Adapter for Maquet anaesthesia machines
Cone Adapter for Model FLOW i



Adapter for Löwenstein anaesthesia machines
Medical Adapter for Leon / Leon plus

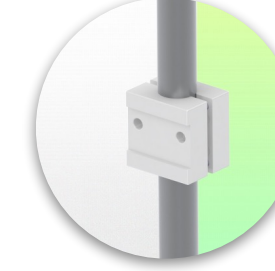

Universal round tube clamp
V-clamp for mounting on round tube \varnothing 23 - 40 mm

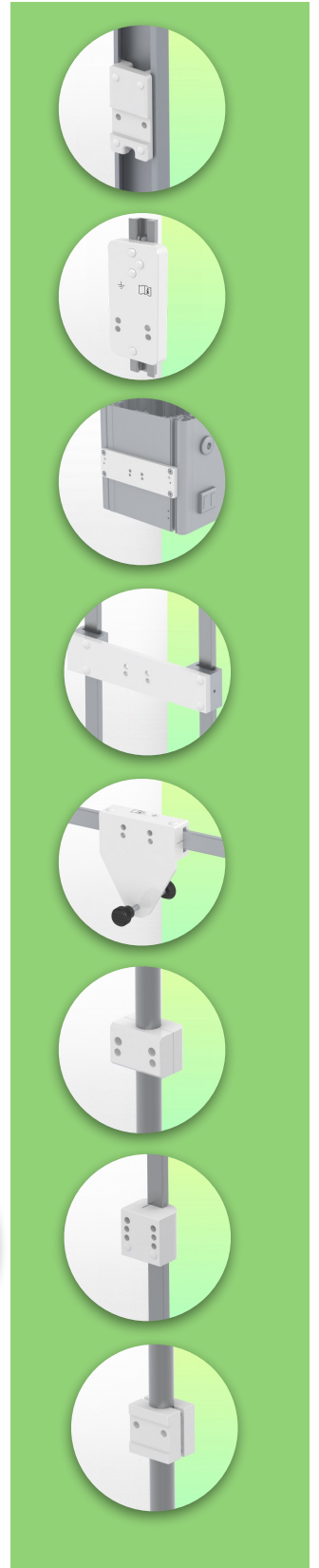

Mounting information - Mounting options

Part Number: WM 222.291CT

Extended Height Adjustable Arm, table column mount.

Supported weight balancing range from 4 to 9 Kg. Overhead mount

Where do you want to mount the support arm?

At the hospital, there are different ways to fix our brackets: round tube, standard rail, wall rail or on an anaesthesia machine. We will always provide you with the adapter you need.

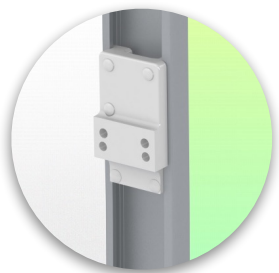

Adapter for anaesthesia machine (all suppliers)

H 80 mm, with existing side rail

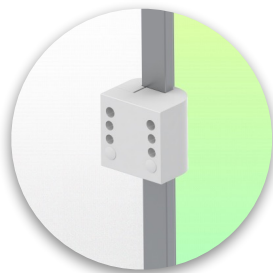

Clamp for a vertical standard rail

For mounting on standard rail 10 x 25 mm

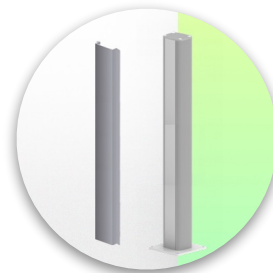
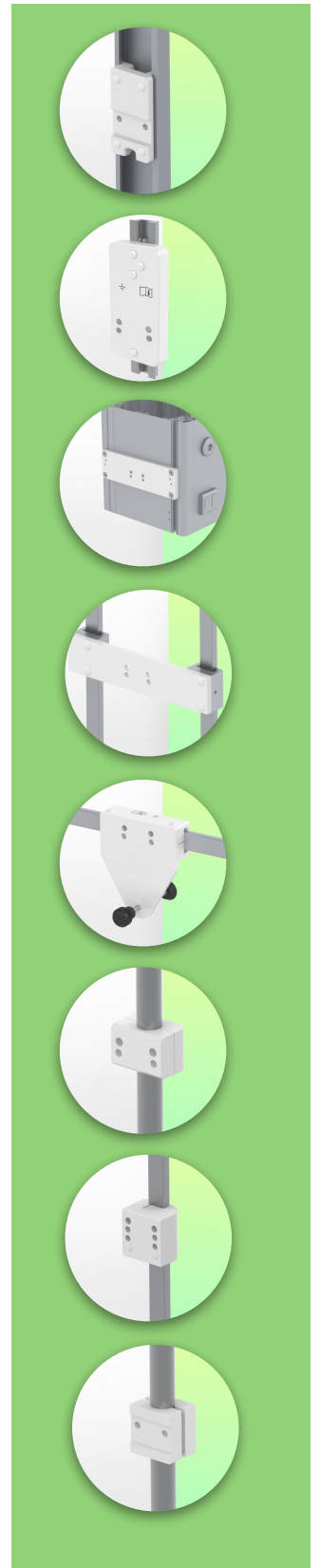
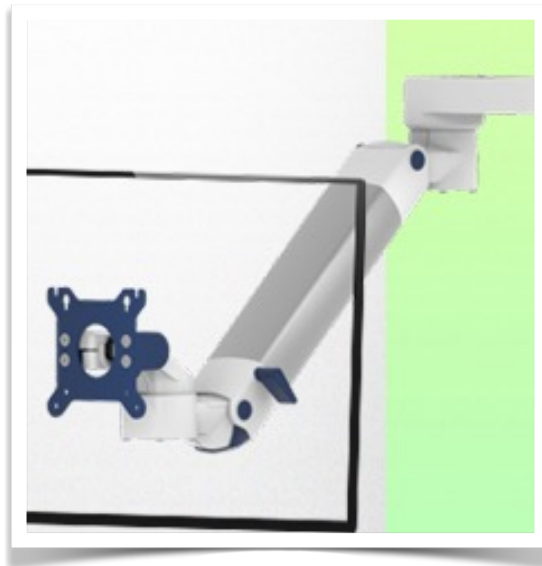
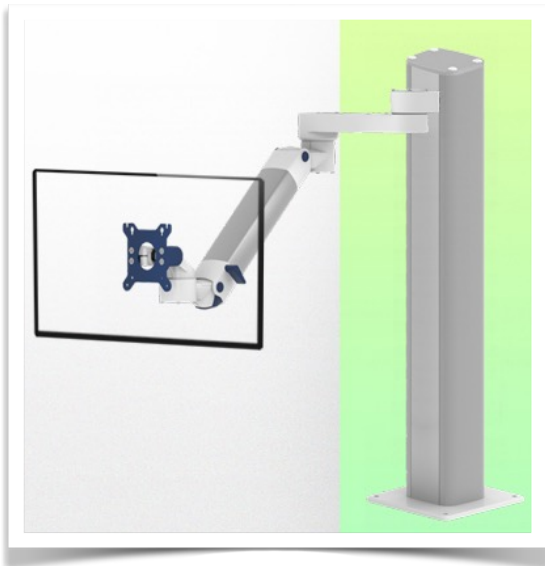

Table column
500 mm or 300 mm



Considered to be the world's best in advanced hygiene control, our medical mounting systems include cable integration, a 5-year maintenance-free warranty and medical grade compliance. We're simply the best in the world at what we do.

Compatible accessories for this mount

Part Number: WM 222.291CT

Extended Height Adjustable Arm, table column mount.

Supported weight balancing range from 4 to 9 Kg. Overhead mount

Compatible accessories for this medical arm

You can complete your installation with these additional accessories:



Triple hook for cable For mounting on support arm



Double hook for cable For mounting on support arm



Downward pole with cable hook For mounting on support arm

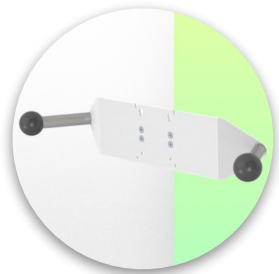

Double handle with VESA mounting For VESA monitors



Handle for VESA monitor support For VESA monitors



Double hook for cable For mounting on a wall or column rail



Triple hook for cable For wall or column rail mounting



Basket For wall or column rail mounting



Downward Pole For mounting on support arm

