

Presentation

Part Number: WM 222.323

**Extended Height Adjustable Arm, Variable Pole Mount from 23 to 40 mm.
Supported weight balancing range from 13 to 16 Kg. Overhead mount**

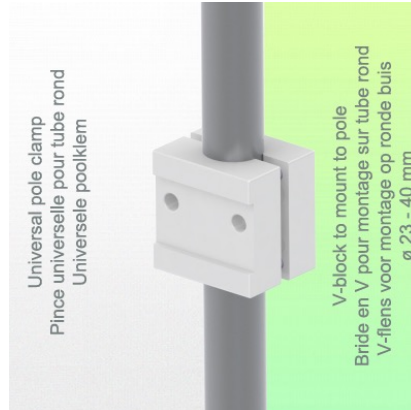
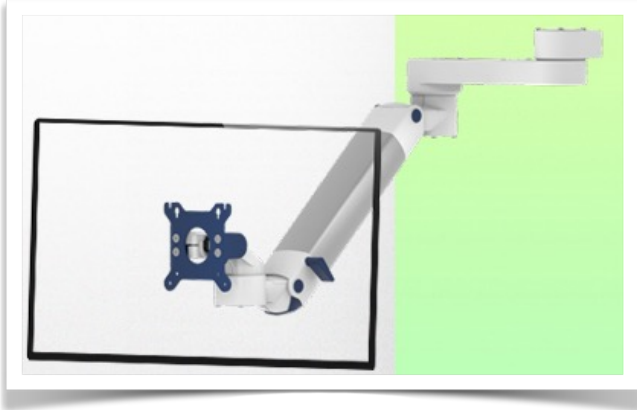

**Extended Height Adjustable Arm, Variable Pole Mount from 23 to 40 mm.
Supported weight balancing range from 13 to 16 Kg. Overhead mount**

When the only available mounting point is high up, this arm gains those crucial extra centimeters lower for ergonomic ease. The Arm extends far in to working space, height adjusts and can be folded back neatly when not use. You need extended reach for your monitor? And the only available mounting position is too high to reach your device? This arm was especially designed for high mounting positions. The arm steps down from the first and second joint. Cable integration offers a neat and clean working environment. A medical-grade arm with easy-to-clean and infection control friendly surfaces, a 5-year warranty and a 6-fold safety factor.

Technical specifications:

- * Integrated cable passage * Equipotential bonding
- * Fixing on the chosen adapter solution
- * This Horizontal extended Arm with gas spring simply adjusts to the desired height and is fixed. * It has a safety stop button for height adjustment, which allows the arm to remain in the chosen position. * The head of this arm complies with the VESA 75/100 mm screen mounting standard.
- * Compatible with screens weighing no more than 13-16 Kg. * Stability touch screen. * Screen tilt: 30° down and 90° up. Screen rotation: 130° right, 180° left.
- * Arm rotation: 90° right, 90° left. * Height adjustment: 45° down, 45° up
- * Total length 808 mm
- * All our medical arms are CE, ROHS, Medical Grade, Regulations MDD 93/42 ECC compliant.
- * Colour RAL 5013 cobalt blue and RAL 9016 traffic white
- * Warranty: 5 years

Technical Specifications

Part Number: WM 222.323

**Extended Height Adjustable Arm, Variable Pole Mount from 23 to 40 mm.
Supported weight balancing range from 13 to 16 Kg. Overhead mount**

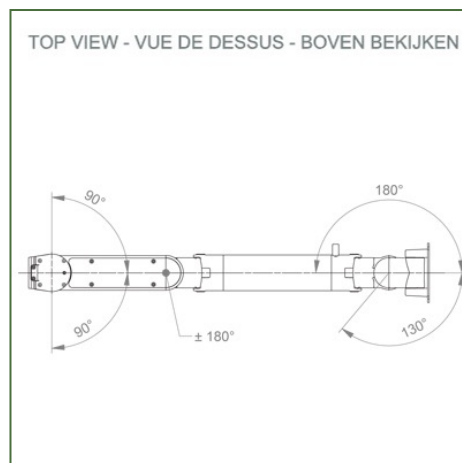
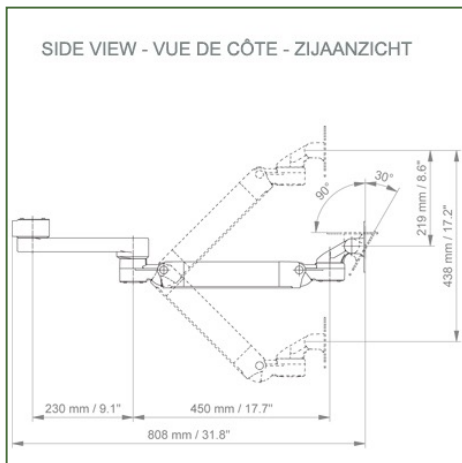
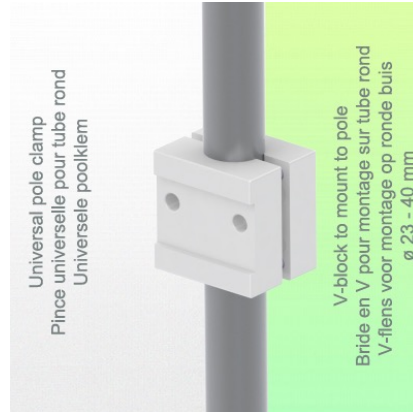
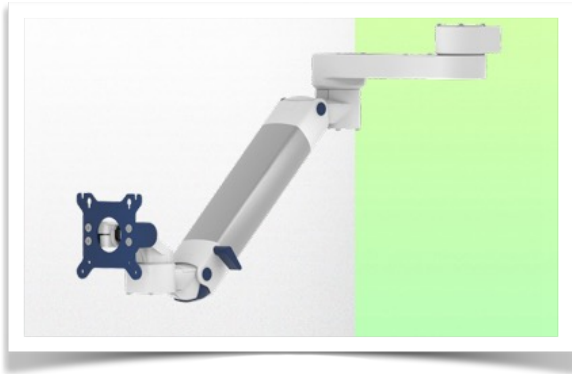

Monitor adaptation: VESA 75/100 mm

Colour: Decorative parts: RAL 5013 cobalt blue

Aluminium parts: RAL 9016 traffic white

Max. load capacity of the support arm: 22 kg

Max. load capacity of the monitor: 18 Kg

Monitor adaptation max. load: 18 Kg

Balancing scale for this medical arm: 13 - 16 Kg

Product weight: 5,2 Kg

Height adjustment: Parallel mechanism for a constant viewing angle
Safety: Has a safety stop button for the height adjustment, which allows the medical arm to remain in the chosen position.



Mounting Information - Fixed pole clamp

Part Number: WM 222.323

**Extended Height Adjustable Arm, Variable Pole Mount from 23 to 40 mm.
Supported weight balancing range from 13 to 16 Kg. Overhead mount**

Variable pole clamp:

Variable Pole mounting \varnothing 23 - 40 mm

* Please specify the diameter of the Pole when ordering.

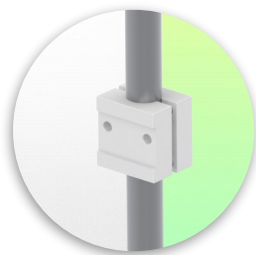
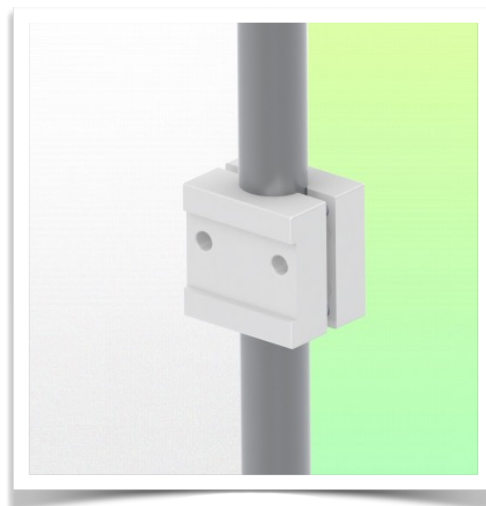

Mounting information - Mounting options

Part Number: WM 222.323

**Extended Height Adjustable Arm, Variable Pole Mount from 23 to 40 mm.
Supported weight balancing range from 13 to 16 Kg. Overhead mount**

Where do you want to mount the support arm?

At the hospital, there are different ways to fix our brackets: round tube, standard rail, wall rail or on an anaesthesia machine. We will always provide you with the adapter you need.



Adapter for vertical wall slide
For wall slide mounting



Adapter for Amico remote controls and wall panels

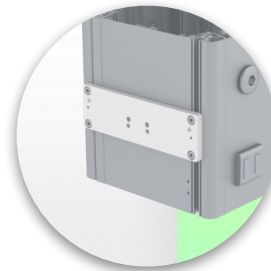

Adapter for Mindray medical power supply units



Double clamp for vertical standard rail
For mounting on two parallel vertical standard rails 10 x 25 mm



Fixed clamp for a standard rail
For mounting on a horizontal standard rail 10 x 25, 8 x 35, 10 x 30, 10 x 50 mm

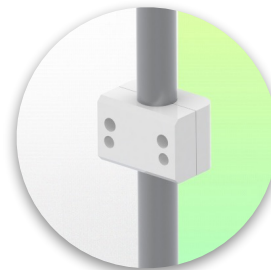

Fixed clamp for round tube
For mounting on round tube \varnothing 25, 35, 38 mm



Adapter for Maquet anaesthesia machines
Cone Adapter for Model FLOW i



Adapter for Löwenstein anaesthesia machines
Medical Adapter for Leon / Leon plus

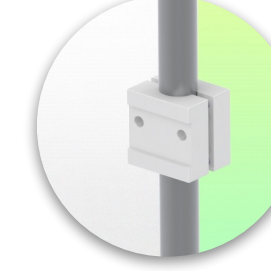

Universal round tube clamp
V-clamp for mounting on round tube \varnothing 23 - 40 mm

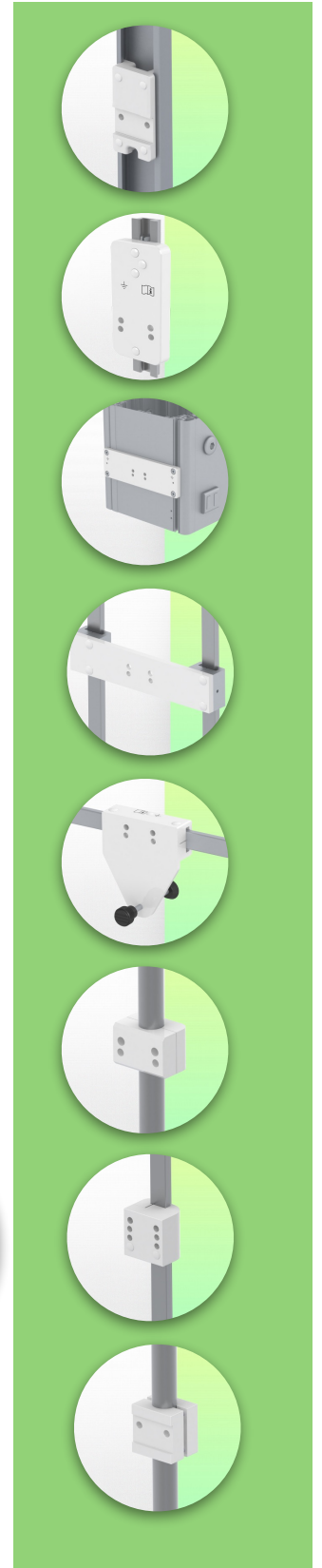

Mounting information - Mounting options

Part Number: WM 222.323

**Extended Height Adjustable Arm, Variable Pole Mount from 23 to 40 mm.
Supported weight balancing range from 13 to 16 Kg. Overhead mount**

Where do you want to mount the support arm?

At the hospital, there are different ways to fix our brackets: round tube, standard rail, wall rail or on an anaesthesia machine. We will always provide you with the adapter you need.



Adapter for anaesthesia machine (all suppliers)

H 80 mm, with existing side rail



Clamp for a vertical standard rail

For mounting on standard rail 10 x 25 mm



Considered to be the world's best in advanced hygiene control, our medical mounting systems include cable integration, a 5-year maintenance-free warranty and medical grade compliance. We're simply the best in the world at what we do.



Compatible accessories for this mount

Part Number: WM 222.323

**Extended Height Adjustable Arm, Variable Pole Mount from 23 to 40 mm.
Supported weight balancing range from 13 to 16 Kg. Overhead mount**

Compatible accessories for this medical Arm

You can complete your installation with these additional accessories:



Triple hook for cable
For mounting on support arm



Double hook for cable
For mounting on support arm



Downward pole with cable hook
For mounting on support arm

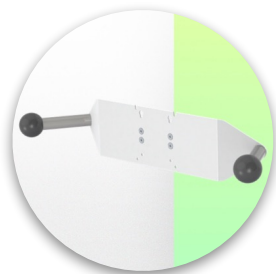

Double handle with VESA mounting
For VESA monitors



Handle for VESA monitor support
For VESA monitors



Double hook for cable
For wall or column rail mounting



Triple hook for cable
For wall or column rail mounting



Basket
For wall or column rail mounting



Downward Pole
For mounting on support arm

