

**Presentation**

**Part Number: WM 222.336**

**Extended Height Adjustable Arm, Mounting on Anesthesia Machines**

**(All manufacturers). Supported weight balancing range from 4 to 9 Kg. Overhead mount**

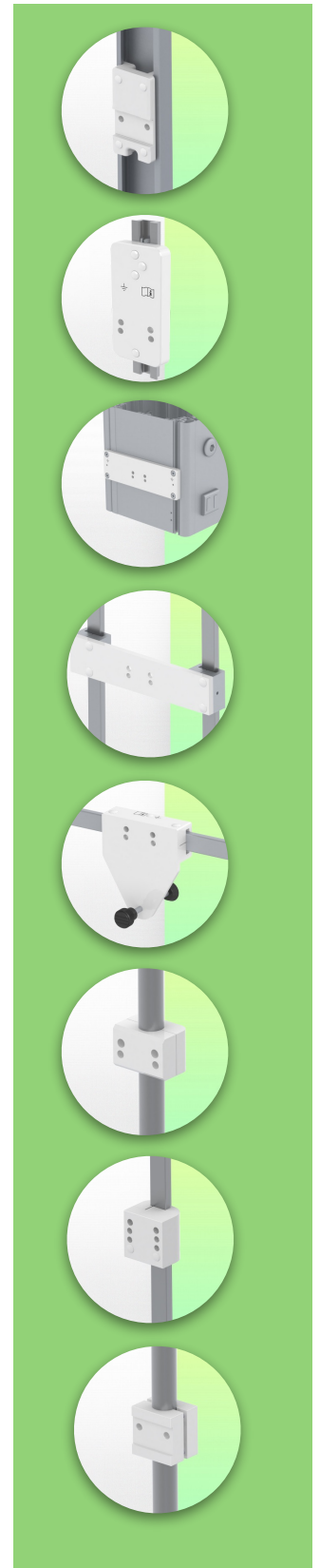
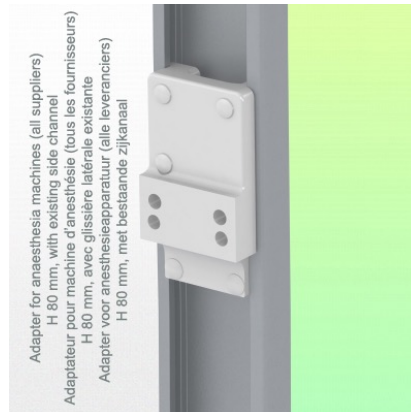
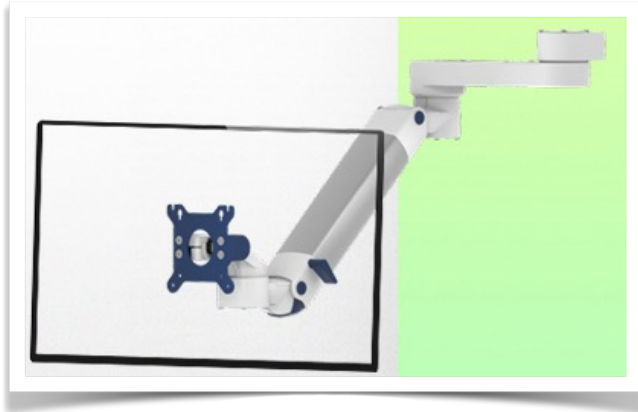

**Extended Height Adjustable Arm, Mounting on Anesthesia Machines (All manufacturers). Supported weight balancing range from 4 to 9 Kg. Overhead mount**

When the only available mounting point is high up, this arm gains those crucial extra centimeters lower for ergonomic ease. The Arm extends far in to working space, height adjusts and can be folded back neatly when not use. You need extended reach for your monitor? And the only available mounting position is too high to reach your device? This arm was especially designed for high mounting positions. The arm steps down from the first and second joint. Cable integration offers a neat and clean working environment. A medical-grade arm with easy-to-clean and infection control friendly surfaces, a 5-year warranty and a 6-fold safety factor.

**Technical specifications:**

- \* Integrated cable passage \* Equipotential bonding
- \* Fixing on the chosen adapter solution
- \* This Horizontal extended Arm with gas spring simply adjusts to the desired height and is fixed. \* It has a safety stop button for height adjustment, which allows the arm to remain in the chosen position. \* The head of this arm complies with the VESA 75/100 mm screen mounting standard.
- \* Compatible with screens weighing no more than 4-9 Kg. \* Stability touch screen.
- \* Screen tilt: 30° down and 90° up. Screen rotation: 130° right, 180° left.
- \* Arm rotation: 90° right, 90° left. \* Height adjustment: 45° down, 45° up
- \* Total length 808 mm
- \* All our medical arms are CE, ROHS, Medical Grade, Regulations MDD 93/42 ECC compliant.
- \* Colour RAL 5013 cobalt blue and RAL 9016 traffic white
- \* Warranty: 5 years

**Technical Specifications**

**Part Number: WM 222.336**

**Extended Height Adjustable Arm, Mounting on Anesthesia Machines**

**(All manufacturers). Supported weight balancing range from 4 to 9 Kg. Overhead mount**

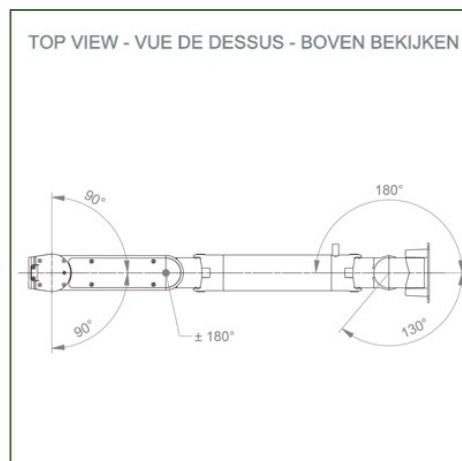
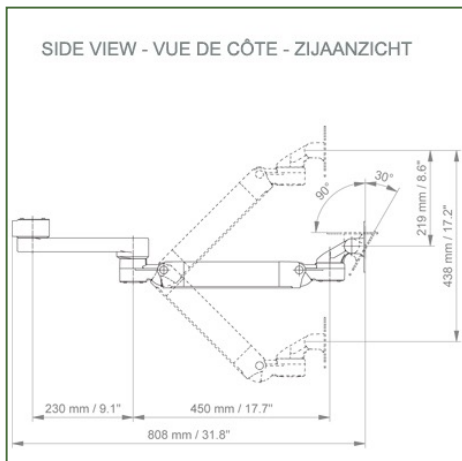
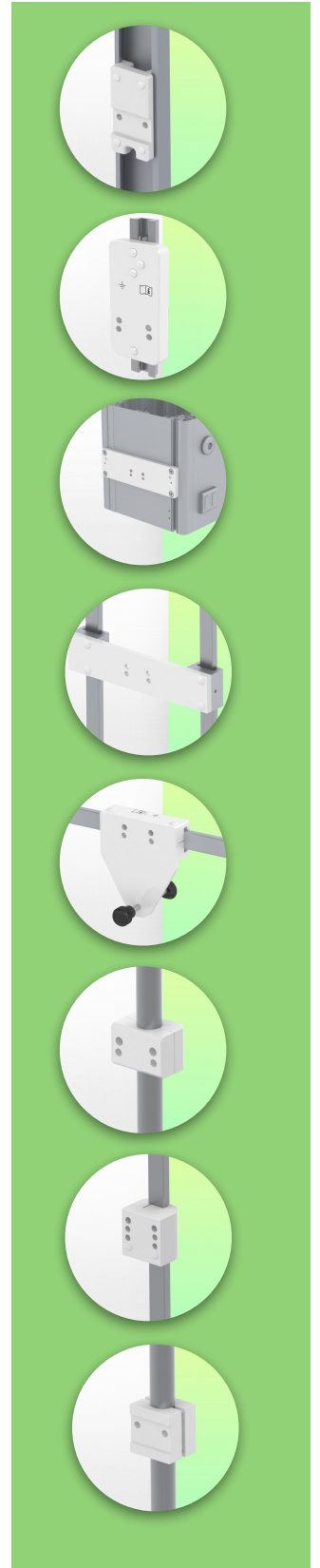
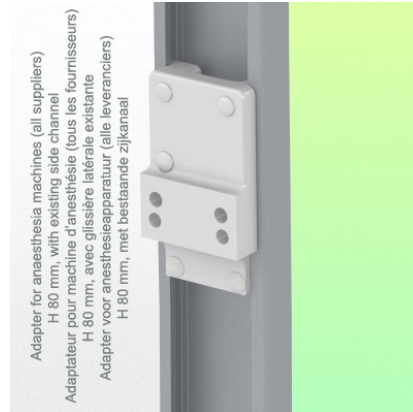
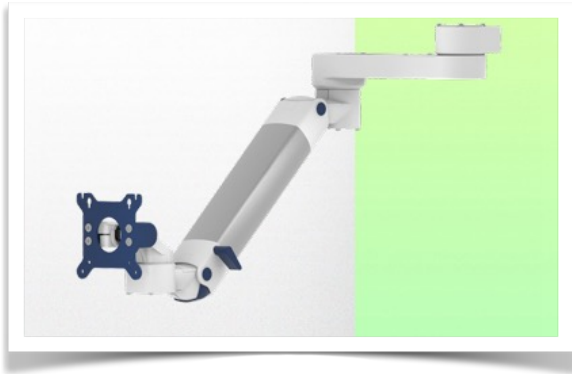

**Monitor adaptation:** VESA 75/100 mm

**Colour:** Decorative parts: RAL 5013 cobalt blue

**Aluminium parts:** RAL 9016 traffic white

**Max. load capacity of the support arm:** 22 kg

**Max. load capacity of the monitor:** 18 Kg

**Monitor adaptation max. load:** 18 Kg

**Balancing scale for this medical arm:** 4 - 9 Kg

**Product weight:** 5,2 Kg

**Height adjustment:** Parallel mechanism for a constant viewing angle  
**Safety:** Has a safety stop button for the height adjustment, which allows the medical arm to remain in the chosen position.



**Mounting Information - Adapter Anesthesia Machines**

**Part Number: WM 222.336**

**Extended Height Adjustable Arm, Mounting on Anesthesia Machines**

**(All manufacturers). Supported weight balancing range from 4 to 9 Kg. Overhead mount**

**Adapter Anesthesia Machines:**

**Mounting on Anaesthesia Machines (All Manufacturers)**

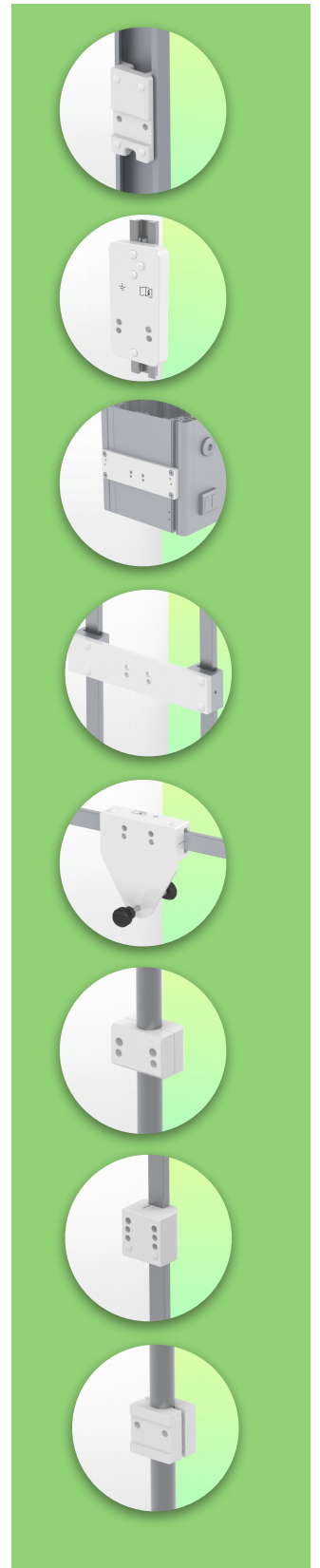

**Mounting information - Mounting options**

**Part Number: WM 222.336**

**Extended Height Adjustable Arm, Mounting on Anesthesia Machines**

**(All manufacturers). Supported weight balancing range from 4 to 9 Kg. Overhead mount**

**Where do you want to mount the support arm?**

At the hospital, there are different ways to fix our brackets: round tube, standard rail, wall rail or on an anaesthesia machine. We will always provide you with the adapter you need.

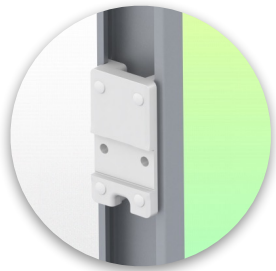

**Adapter for vertical wall slide**  
For wall slide mounting



**Adapter for Amico remote controls and wall panels**

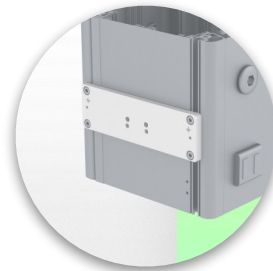

**Adapter for Mindray medical power supply units**



**Double clamp for vertical standard rail**  
For mounting on two parallel vertical standard rails 10 x 25 mm

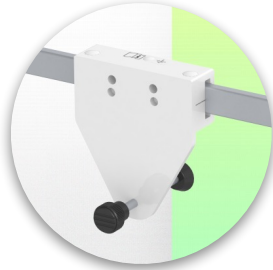

**Fixed clamp for a standard rail**  
For mounting on a horizontal standard rail 10 x 25, 8 x 35, 10 x 30, 10 x 50 mm

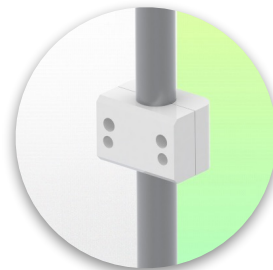

**Fixed clamp for round tube**  
For mounting on round tube  $\varnothing$  25, 35, 38 mm

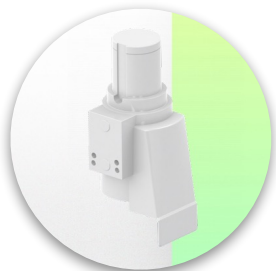

**Adapter for Maquet anaesthesia machines**  
Cone Adapter for Model FLOW i



**Adapter for Löwenstein anaesthesia machines**  
Medical Adapter for Leon / Leon plus

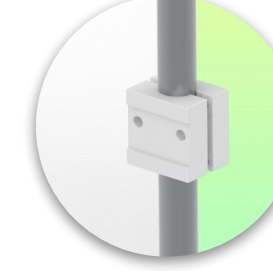

**Universal round tube clamp**  
V-clamp for mounting on round tube  $\varnothing$  23 - 40 mm

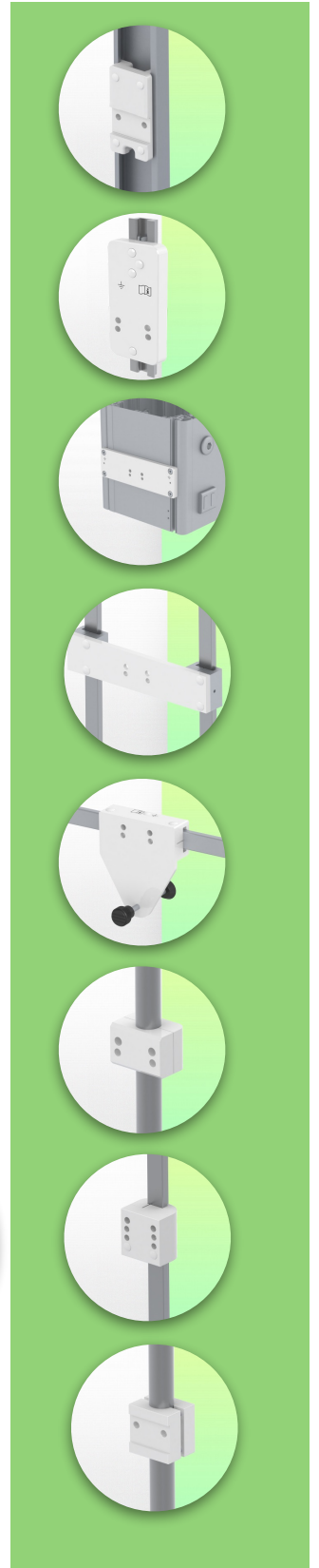



**Mounting information - Mounting options**

**Part Number: WM 222.336**

**Extended Height Adjustable Arm, Mounting on Anesthesia Machines  
(All manufacturers). Supported weight balancing range from 4 to 9 Kg. Overhead mount**

**Where do you want to mount the support arm?**

At the hospital, there are different ways to fix our brackets: round tube, standard rail, wall rail or on an anaesthesia machine. We will always provide you with the adapter you need.



**Adapter for anaesthesia machine (all suppliers)**

H 80 mm, with existing side rail



**Clamp for a vertical standard rail**

For mounting on standard rail 10 x 25 mm



Considered to be the world's best in advanced hygiene control, our medical mounting systems include cable integration, a 5-year maintenance-free warranty and medical grade compliance. We're simply the best in the world at what we do.



Compatible accessories for this mount

Part Number: WM 222.336

**Extended Height Adjustable Arm, Mounting on Anesthesia Machines  
(All manufacturers). Supported weight balancing range from 4 to 9 Kg. Overhead mount**

**Compatible accessories for this 300 mm Medical Arm**

You can complete your installation with these additional accessories:



**Triple hook for cable**  
For mounting on support arm



**Double hook for cable**  
For mounting on support arm



**Downward pole with cable hook**  
For mounting on support arm

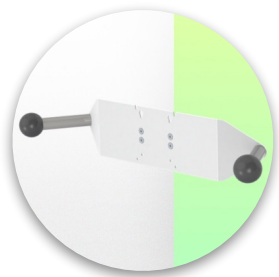

**Double handle with VESA mounting**  
For VESA monitors



**Handle for VESA monitor support**  
For VESA monitors



**Double hook for cable**  
For wall or column rail mounting



**Triple hook for cable**  
For wall or column rail mounting



**Basket**  
For wall or column rail mounting



**Downward Pole**  
For mounting on support arm

