

**Presentation**

**Part Number: WM 225.126**

**Medical Combo arm Standard adjustable in height by 300 mm, Vertical Din rail mounting. Supported weight balancing range from 2,5 to 5,5 Kg**

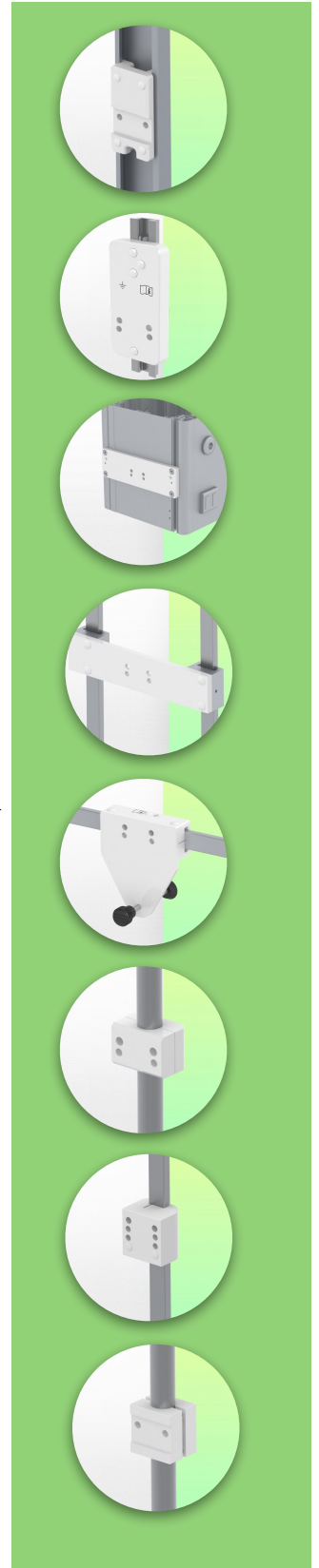
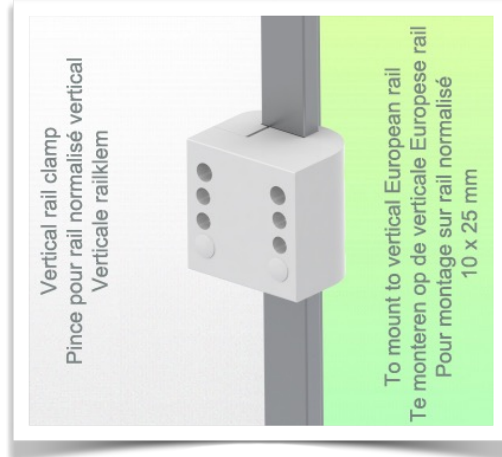

This 300 mm long height adjustable Combo Medical Arm allows to fix, orientate and adjust perfectly a screen, its keyboard support with dimensions of 500 x 202 mm delivered with this configuration allows to welcome a standard keyboard as well as a mouse. As an option, it can be equipped with a stand with a sliding right/left mouse tray with dimensions of 480 x 220 mm for the keyboard and 226 x 220 mm for the mouse, or with a large keyboard stand with dimensions of 580 x 200 mm. It has a safety stop button for the height adjustment, which allows the arm to remain in the selected position.

**Technical specifications:**

- \* Integrated cable channel
- \* Standard keyboard support 500 x 202 mm
- Fixing on Din Vertical Rail Standard 10 x 25, 8 x 35, 10 x 30, 10 x 50 mm.
- (See Options on the following pages)
- \* This standard Combo Arm with height adjustment is 300mm long and simply clips into the Din Horizontal Rail and then adjusts to the required height and is fixed
- \* The head of this arm conforms to the VESA 75/100mm screen mounting standard
- \* Compatible with equipment weighing up to 2,5-5,5 Kg
- \* Tilting of the screen: 10°
- \* Rotation of the arm: 90° to the right, 90° to the left from the fixing point
- \* Rotation of the keyboard and screen support: 100° to the right, 100° to the left
- \* Total length of the configuration 857 mm
- \* Colour RAL 5013 cobalt blue and RAL 9016 traffic white
- \* Warranty: 5 years

**Technical specifications**

**Part Number: WM 225.126**

**Medical Combo arm Standard adjustable in height by 300 mm, Vertical Din rail mounting.  
Supported weight balancing range from 2,5 to 5,5 Kg**

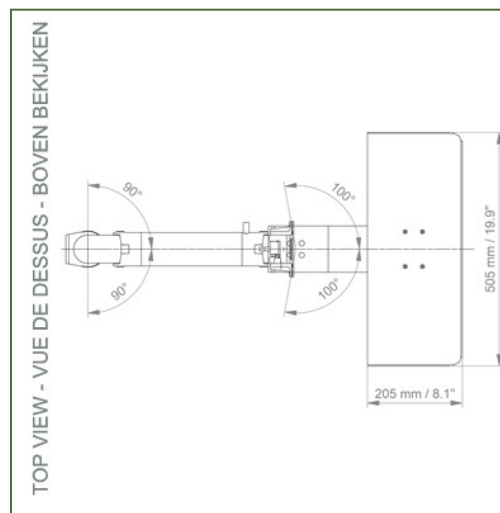
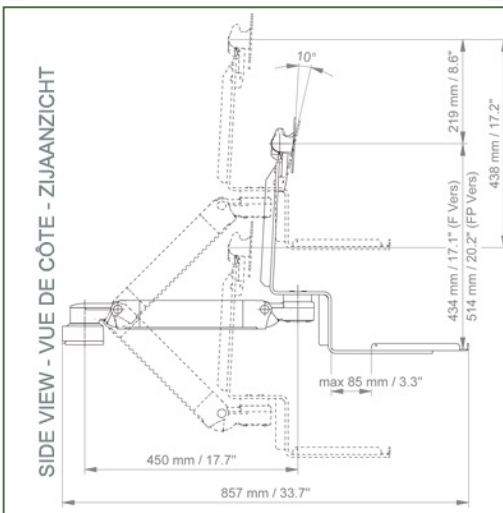
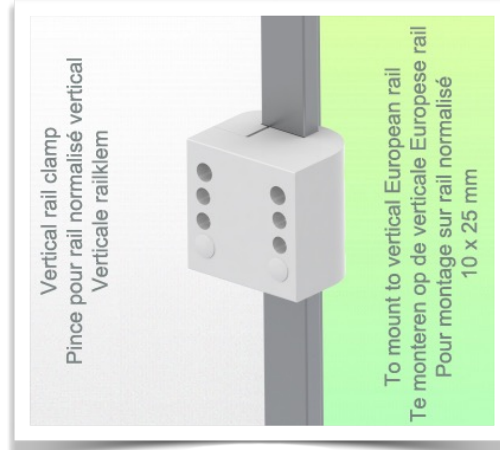

**Monitor adaptation:** VESA 75/100 mm

**Colour:** Decorative parts: RAL 5013 cobalt blue Aluminium parts: RAL 9016 traffic white

**Balance scale of this medical arm:** 2,5 - 5,5 Kg

**Product weight:** 4,9 - 6,5 Kg (depending on the dimensions of the keyboard tray)

**Height adjustment:** Parallel mechanism for a constant viewing angle

**Safety:** Has a safety stop button for height adjustment, which allows the medical arm to remain in the chosen position.

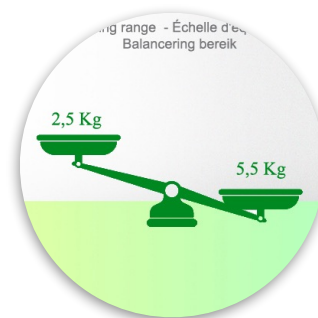
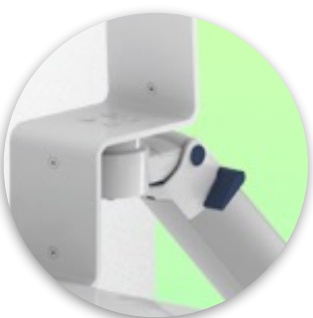

**Mounting information - Din Horizontal Rail**

**Part Number: WM 225.126**

**Medical Combo arm Standard adjustable in height by 300 mm, Vertical Din rail mounting.  
Supported weight balancing range from 2,5 to 5,5 Kg**

**Din Vertical Rail Mount:**

Standard Rail Clamp For mounting on a vertical standard rail  
10 x 25, 8 x 35, 10 x 30, 10 x 50 mm

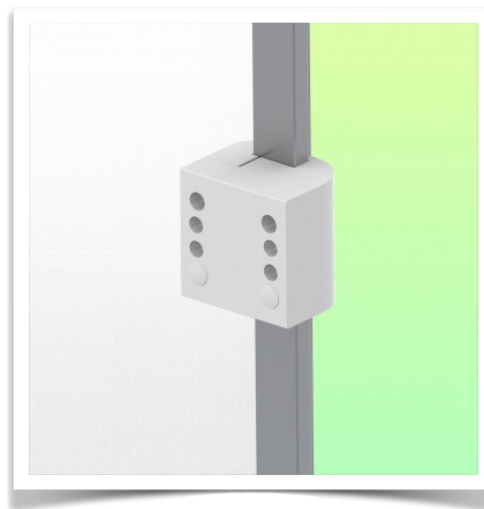
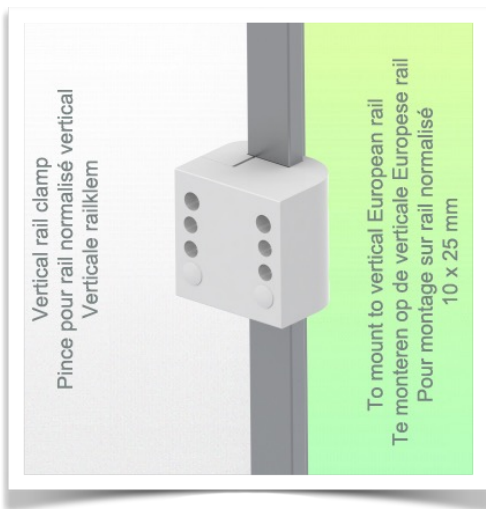

**Product Highlights:**

Height adjustable arms offer full cable integration and easy cleaning for infection control in all critical care areas of the clinical environment. Our 5-year warranty ensures reliable, trouble-free and maintenance-free operation. The swivel function at the point of attachment as well as the tilt and swivel function of the monitor adaptation offer optimal positioning of your device. The height-adjustable arm in its extended version is a two-part arm with a central pivot point between the two arm sections. All bottom mounted monitors have the safety feature of a 20° tilt stop.



**Mounting Information - Mounting Options**

**Part Number: WM 225.126**

**Medical Combo arm Standard adjustable in height by 300 mm, Vertical Din rail mounting.  
Supported weight balancing range from 2,5 to 5,5 Kg**

**Where do you want to mount the support arm?**

At the hospital, there are different ways to fix our brackets: round tube, standard rail, wall rail or on an anaesthesia machine. We will always provide you with the adapter you need.



**Adapter for vertical wall slide**  
For wall slide mounting



**Adapter for Amico remote controls and wall panels**



**Adapter for Mindray medical power supply units**



**Double clamp for vertical standard rail**  
For mounting on two parallel vertical standard rails 10 x 25 mm



**Fixed clamp for a standard rail**  
For mounting on a horizontal standard rail 10 x 25, 8 x 35, 10 x 30, 10 x 50 mm



**Fixed clamp for round tube**  
For mounting on round tube  $\varnothing$  25, 35, 38 mm



**Adapter for Maquet anaesthesia machines**  
Cone Adapter for Model FLOW i



**Adapter for Löwenstein anaesthesia machines**  
Medical Adapter for Leon / Leon plus



**Universal round tube clamp**  
V-clamp for mounting on round tube  $\varnothing$  23 - 40 mm





**Mounting Information - Mounting Options**

**Part Number: WM 225.126**

**Medical Combo arm Standard adjustable in height by 300 mm, Vertical Din rail mounting. Supported weight balancing range from 2,5 to 5,5 Kg**

**Where do you want to mount the support arm?**

At the hospital, there are different ways to fix our brackets: round tube, standard rail, wall rail or on an anaesthesia machine. We will always provide you with the adapter you need.

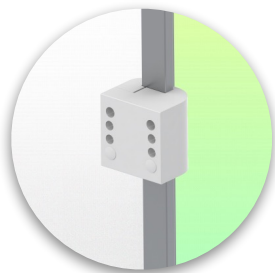
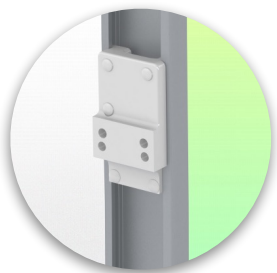

**Clamp for a vertical standard rail**

For mounting on standard rail 10 x 25 mm

**Adapter for anaesthesia machine (all suppliers)**

H 80 mm, with existing side rail

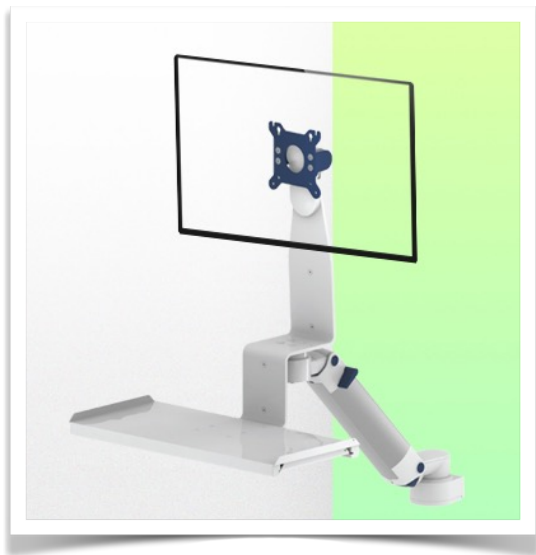

**Product Highlights:**

Height adjustable arms offer full cable integration and easy cleaning for infection control in all critical care areas of the clinical environment. Our 5-year warranty ensures reliable, trouble-free and maintenance-free operation. The swivel function at the point of attachment as well as the tilt and swivel function of the monitor adaptation offer optimal positioning of your device. The height-adjustable arm in its extended version is a two-part arm with a central pivot point between the two arm sections. All bottom mounted monitors have the safety feature of a 20° tilt stop.



Considered to be the world's best in advanced hygiene control, our medical mounting systems include cable integration, a 5-year maintenance-free warranty and medical grade compliance. We're simply the best in the world at what we do.

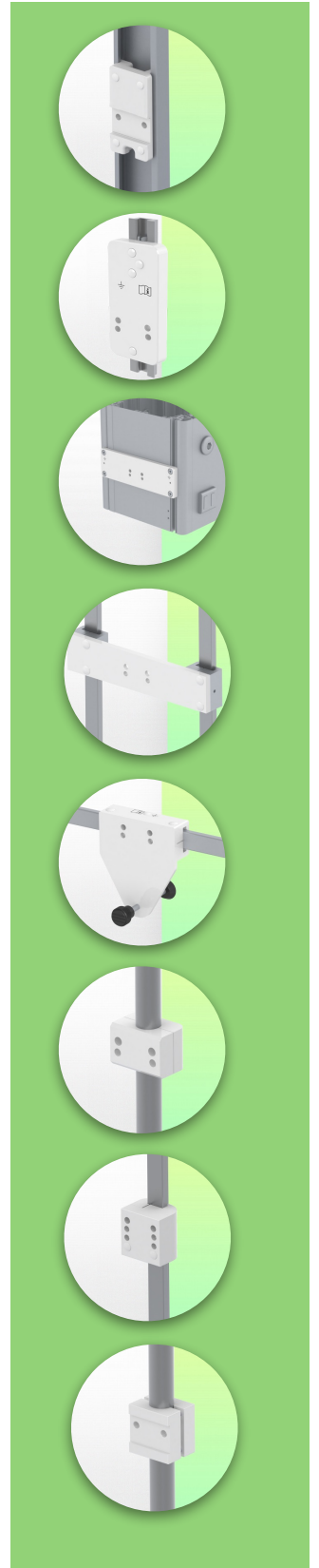

Technical drawing of this Combo configuration

Part Number: WM 225.126

Medical Combo arm Standard adjustable in height by 300 mm, Vertical Din rail mounting.  
Supported weight balancing range from 2,5 to 5,5 Kg

