

Presentation

Part Number: WM 225.127

Medical Combo arm Standard adjustable in height by 300 mm, Vertical Din rail mounting. Supported weight balancing range from 6 to 10 Kg

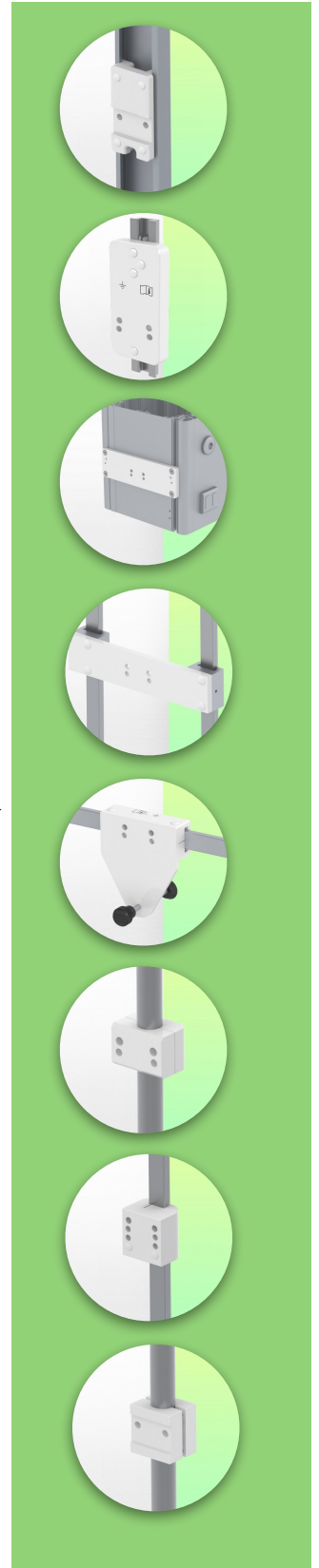
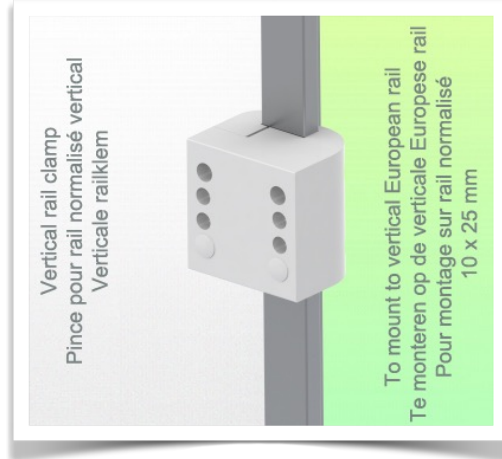
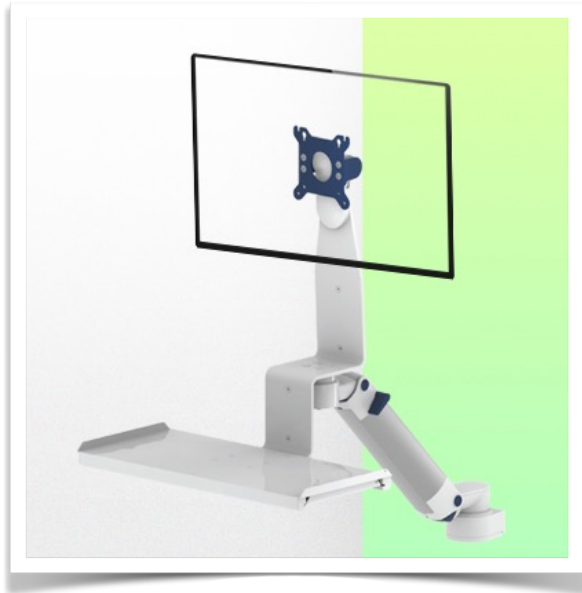

This 300 mm long height adjustable Combo Medical Arm allows to fix, orientate and adjust perfectly a screen, its keyboard support with dimensions of 500 x 202 mm delivered with this configuration allows to welcome a standard keyboard as well as a mouse. As an option, it can be equipped with a stand with a sliding right/left mouse tray with dimensions of 480 x 220 mm for the keyboard and 226 x 220 mm for the mouse, or with a large keyboard stand with dimensions of 580 x 200 mm. It has a safety stop button for the height adjustment, which allows the arm to remain in the selected position.

Technical specifications:

* Integrated cable channel * Standard keyboard support 500 x 202 mm Fixing on Din Vertical Rail Standard 10 x 25, 8 x 35, 10 x 30, 10 x 50 mm.

(See Options on the following pages) * This standard Combo Arm with height adjustment is 300mm long and simply clips into the Din Horizontal Rail and then adjusts to the required height and is fixed * The head of this arm conforms to the VESA 75/100mm screen mounting standard * Compatible with equipment weighing up to 6-10 Kg * Tilting of the screen: 10° * Rotation of the arm: 90° to the right, 90° to the left from the fixing point * Rotation of the keyboard and screen support: 100° to the right, 100° to the left * Total length of the configuration 857 mm * Colour RAL 5013 cobalt blue and RAL 9016 traffic white * Warranty: 5 years

Technical specifications

Part Number: WM 225.127

Medical Combo arm Standard adjustable in height by 300 mm, Vertical Din rail mounting.
Supported weight balancing range from 6 to 10 Kg

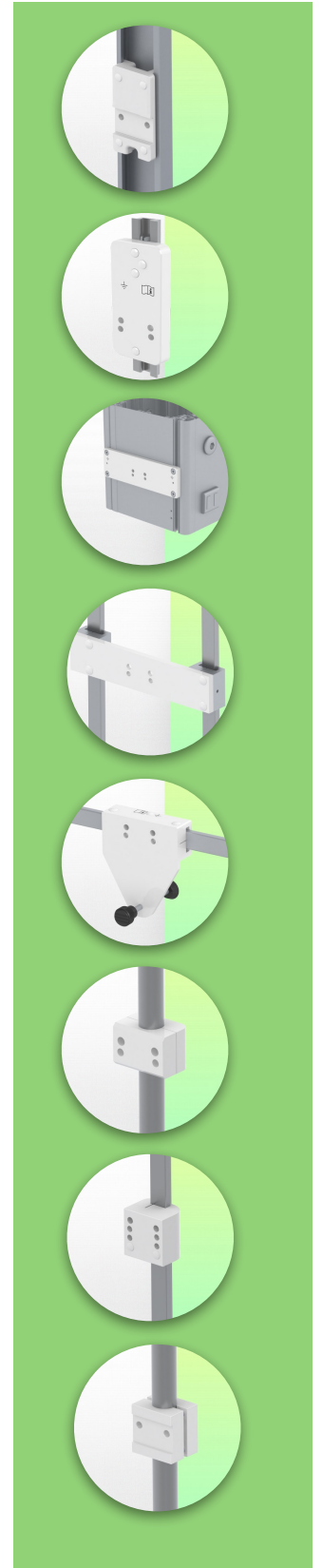
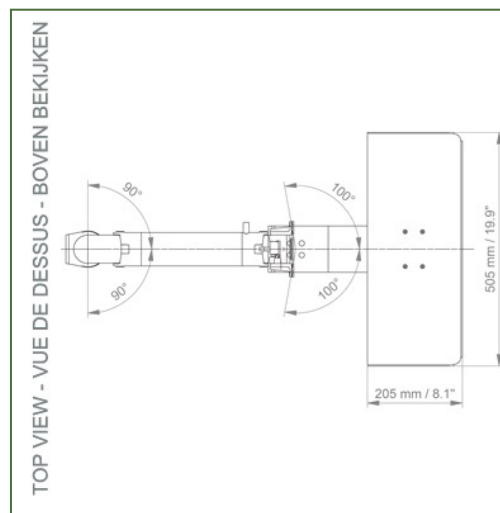
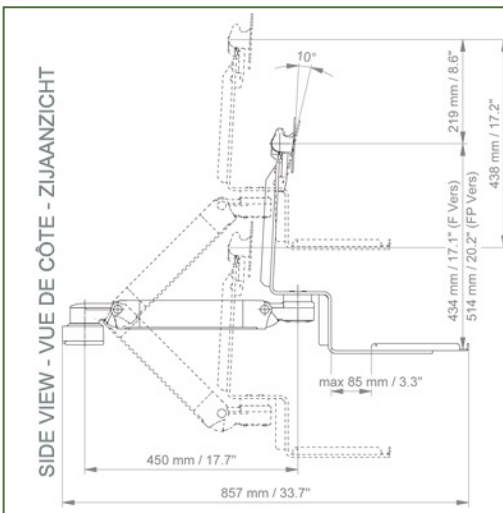
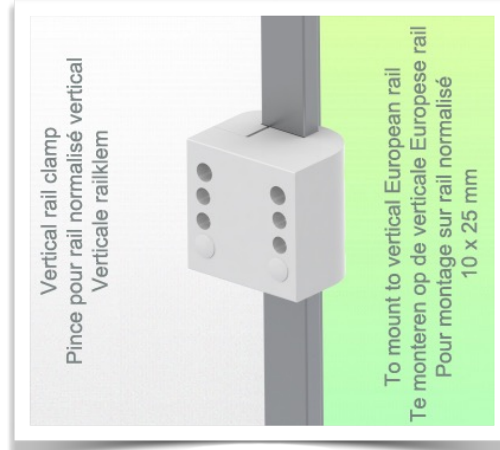

Monitor adaptation: VESA 75/100 mm

Colour: Decorative parts: RAL 5013 cobalt blue Aluminium parts: RAL 9016 traffic white

Balance scale of this medical arm: 6 - 10 Kg

Product weight: 4,9 - 6,5 Kg (depending on the dimensions of the keyboard tray)

Height adjustment: Parallel mechanism for a constant viewing angle

Safety: Has a safety stop button for height adjustment, which allows the medical arm to remain in the chosen position.

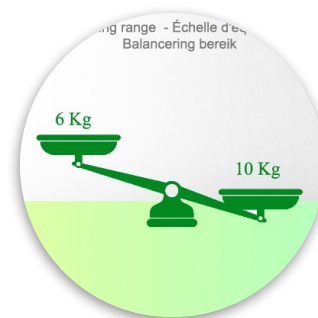
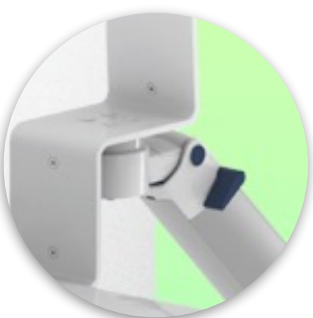

Mounting information - Din Horizontal Rail

Part Number: WM 225.127

Medical Combo arm Standard adjustable in height by 300 mm, Vertical Din rail mounting. Supported weight balancing range from 6 to 10 Kg

Din Vertical Rail Mount:

Standard Rail Clamp For mounting on a vertical standard rail
10 x 25, 8 x 35, 10 x 30, 10 x 50 mm

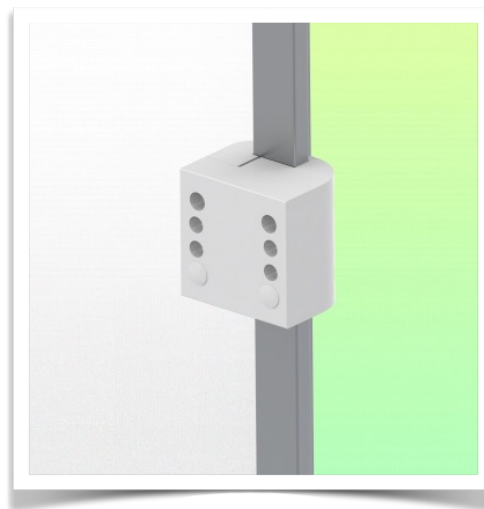
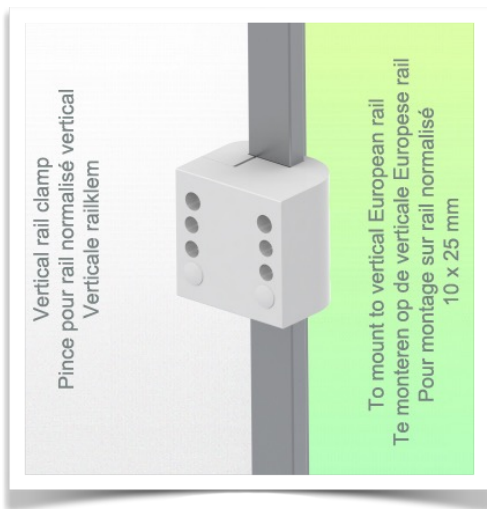

Product Highlights:

Height adjustable arms offer full cable integration and easy cleaning for infection control in all critical care areas of the clinical environment. Our 5-year warranty ensures reliable, trouble-free and maintenance-free operation. The swivel function at the point of attachment as well as the tilt and swivel function of the monitor adaptation offer optimal positioning of your device. The height-adjustable arm in its extended version is a two-part arm with a central pivot point between the two arm sections. All bottom mounted monitors have the safety feature of a 20° tilt stop.

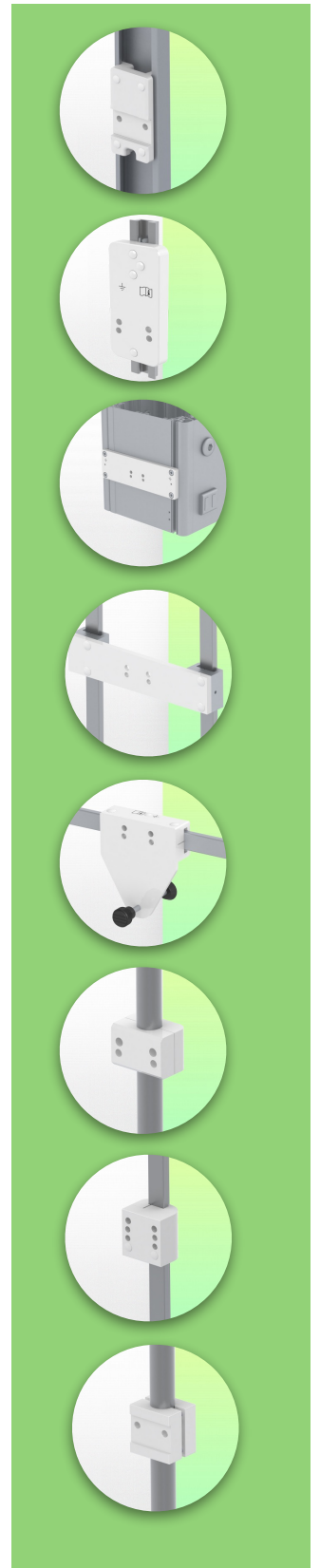

Mounting Information - Mounting Options

Part Number: WM 225.127

**Medical Combo arm Standard adjustable in height by 300 mm, Vertical Din rail mounting.
Supported weight balancing range from 6 to 10 Kg**

Where do you want to mount the support arm?

At the hospital, there are different ways to fix our brackets: round tube, standard rail, wall rail or on an anaesthesia machine. We will always provide you with the adapter you need.



Adapter for vertical wall slide
For wall slide mounting



Adapter for Amico remote controls and wall panels



Adapter for Mindray medical power supply units



Double clamp for vertical standard rail
For mounting on two parallel vertical standard rails 10 x 25 mm



Fixed clamp for a standard rail
For mounting on a horizontal standard rail 10 x 25, 8 x 35, 10 x 30, 10 x 50 mm



Fixed clamp for round tube
For mounting on round tube \varnothing 25, 35, 38 mm



Adapter for Maquet anaesthesia machines
Cone Adapter for Model FLOW i



Adapter for Löwenstein anaesthesia machines
Medical Adapter for Leon / Leon plus



Universal round tube clamp
V-clamp for mounting on round tube \varnothing 23 - 40 mm

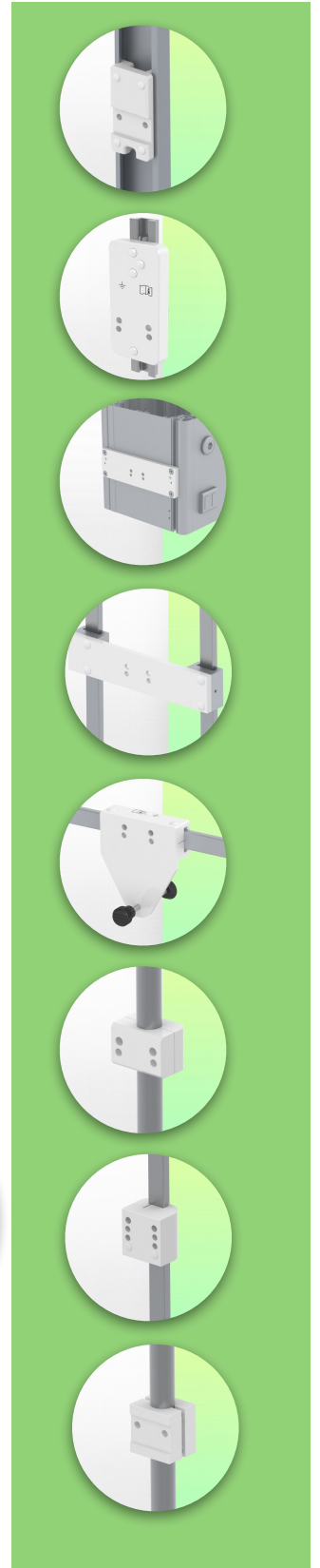

Mounting Information - Mounting Options

Part Number: WM 225.127

Medical Combo arm Standard adjustable in height by 300 mm, Vertical Din rail mounting. Supported weight balancing range from 6 to 10 Kg

Where do you want to mount the support arm?

At the hospital, there are different ways to fix our brackets: round tube, standard rail, wall rail or on an anaesthesia machine. We will always provide you with the adapter you need.

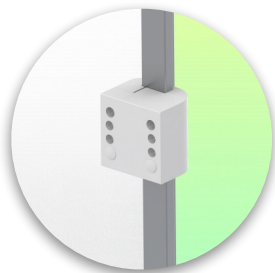
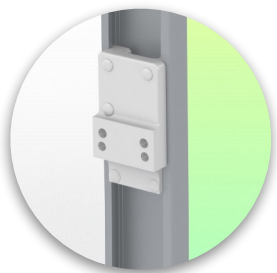

Clamp for a vertical standard rail

For mounting on standard rail 10 x 25 mm

Adapter for anaesthesia machine (all suppliers)

H 80 mm, with existing side rail

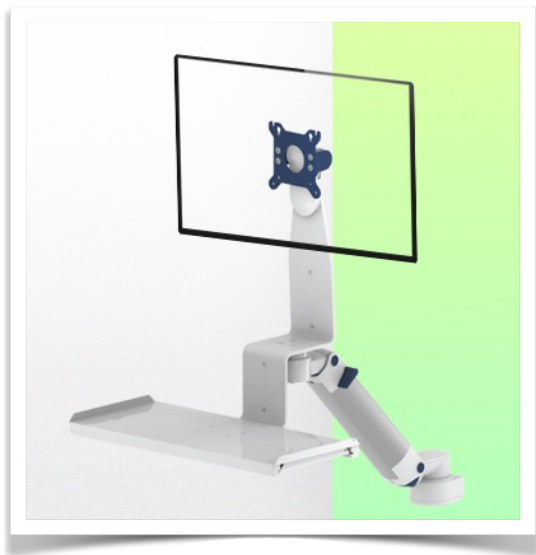

Product Highlights:

Height adjustable arms offer full cable integration and easy cleaning for infection control in all critical care areas of the clinical environment. Our 5-year warranty ensures reliable, trouble-free and maintenance-free operation. The swivel function at the point of attachment as well as the tilt and swivel function of the monitor adaptation offer optimal positioning of your device. The height-adjustable arm in its extended version is a two-part arm with a central pivot point between the two arm sections. All bottom mounted monitors have the safety feature of a 20° tilt stop.



Considered to be the world's best in advanced hygiene control, our medical mounting systems include cable integration, a 5-year maintenance-free warranty and medical grade compliance. We're simply the best in the world at what we do.

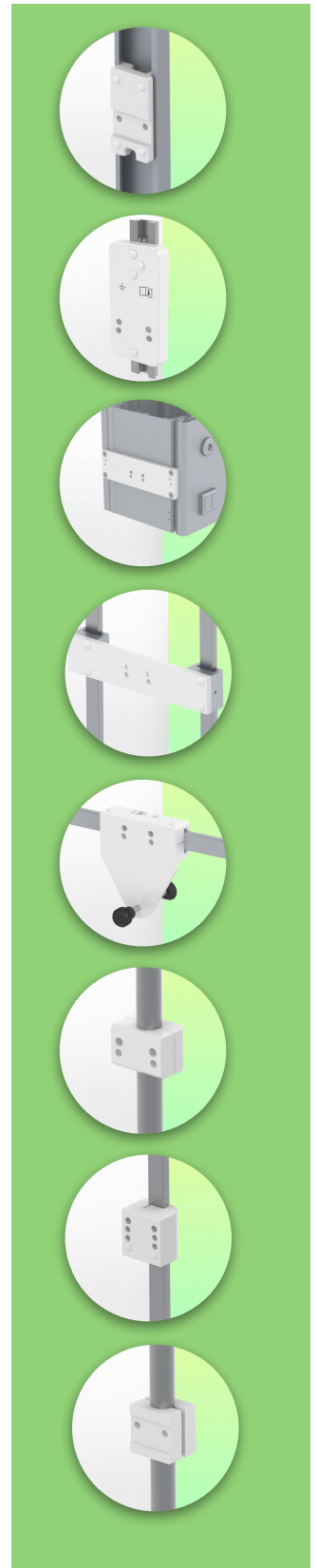



Technical drawing of this Combo configuration

Part Number: WM 225.127

Medical Combo arm Standard adjustable in height by 300 mm, Vertical Din rail mounting.
Supported weight balancing range from 6 to 10 Kg

