

## Presentation

Part Number: WM 225.181

Medical Combo arm Standard adjustable in height by 2 x 300 mm, fixing on table column.  
Supported weight balance scale from 6 to 10 Kg

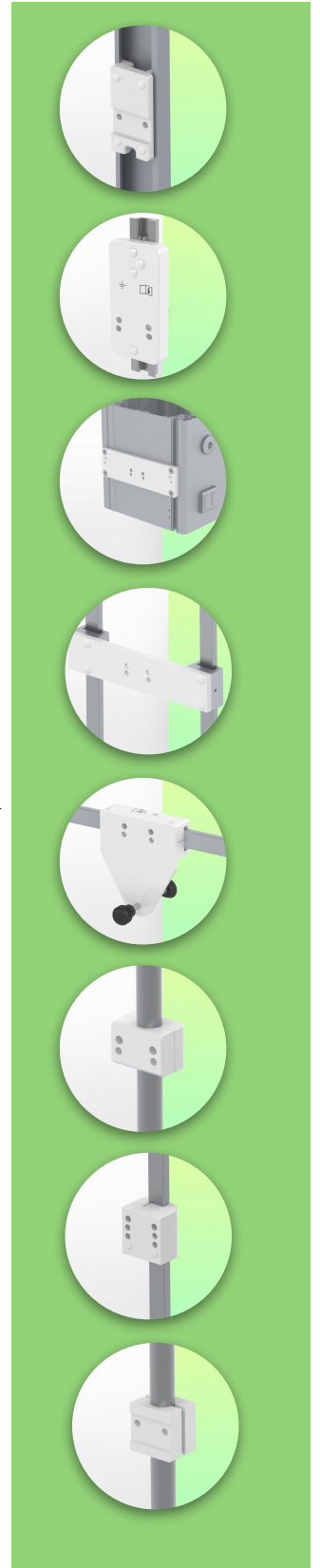
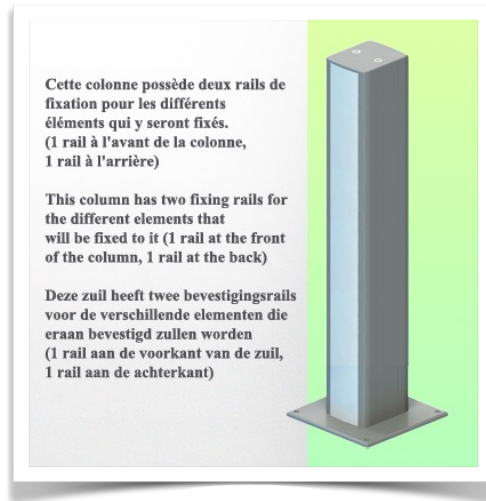
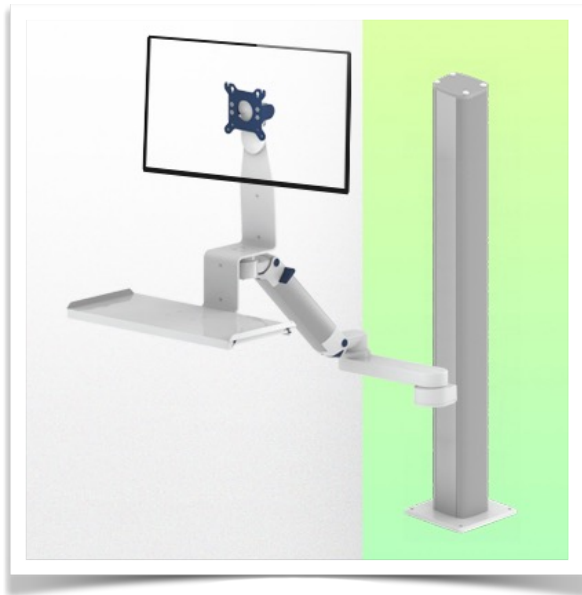

This 2 x 300 mm long height adjustable Combo Medical Arm allows to fix, orientate and adjust perfectly a screen, its keyboard support with dimensions of 500 x 202 mm delivered with this configuration allows to welcome a standard keyboard as well as a mouse. As an option, it can be equipped with a stand with a sliding right/left mouse tray with dimensions of 480 x 220 mm for the keyboard and 226 x 220 mm for the mouse, or with a large keyboard stand with dimensions of 580 x 200 mm. It has a safety stop button for the height adjustment, which allows the arm to remain in the selected **position**.

## Technical specifications:

- \* Integrated cable management \* Standard keyboard support 500 x 202 mm Optional floor or table columns are available in various heights (300 - 500 mm). These columns can be easily cut to size. All cables are also routed through the column. (See Option on the following pages) \* This standard Combo Arm with height adjustment is 2 x 300 mm long and simply slides into the column rail and then adjusts to the required height and is fixed \* The head of this arm complies with the screen mounting standard: VESA 75/100 mm \* Compatible with equipment weighing up to 6 - 10 kg.
- \* Tilting of the screen: 10° \* Rotation of the arm: 90° to the right, 90° to the left from the fixing point \* Rotation of the keyboard and screen support: 100° to the right, 100° to the left. \* Rotation of the central axis between the two arms 180°.
- \* Total length of the configuration 1087 mm \* Colour RAL 5013 cobalt blue and RAL 9016 traffic white \* Warranty: 5 years

**Technical specifications**

**Part Number: WM 225.181**

**Medical Combo arm Standard adjustable in height by 2 x 300 mm, fixing on table column.  
Supported weight balance scale from 6 to 10 Kg**

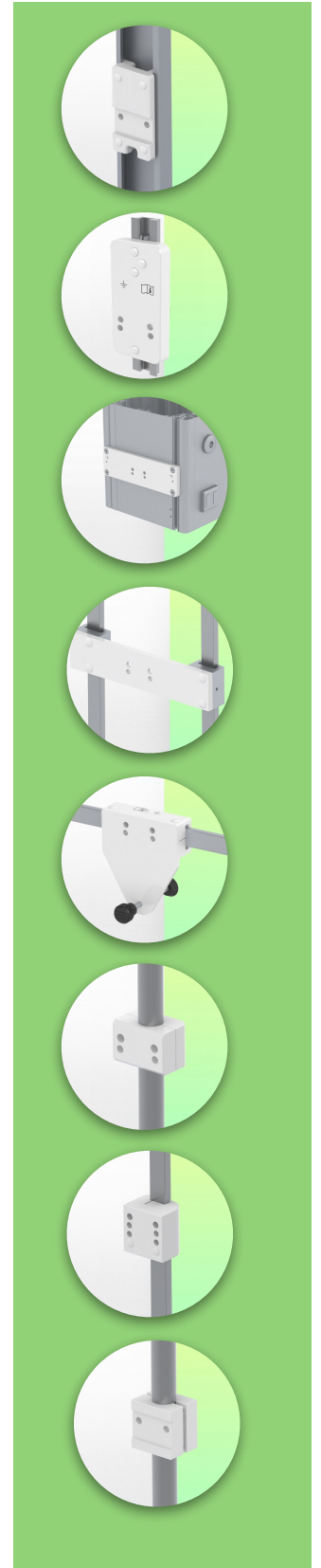
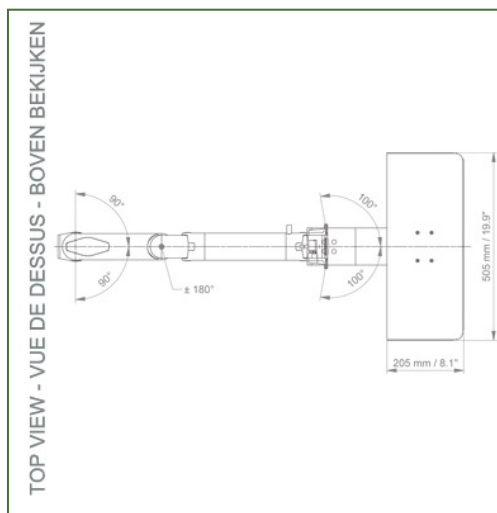
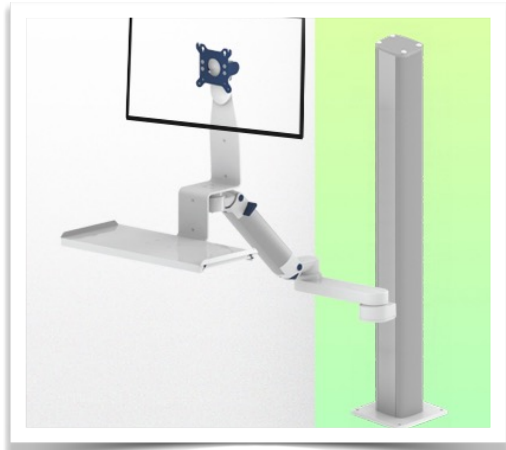

**Monitor adaptation:** VESA 75/100 mm

**Colour:** Decorative parts: RAL 5013 cobalt blue

**Aluminium parts:** RAL 9016 traffic white

**Balance scale of this medical arm:** 6 - 10 Kg

**Product weight:** 6,4 - 7,9 Kg (depending on the dimensions of the keyboard tray)

**Height adjustment:** Parallel mechanism for a constant viewing angle  
**Safety:** Has a safety stop button for height adjustment, which allows the medical arm to remain in the chosen position.

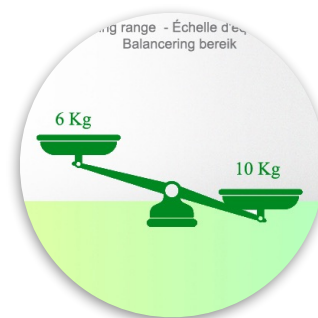
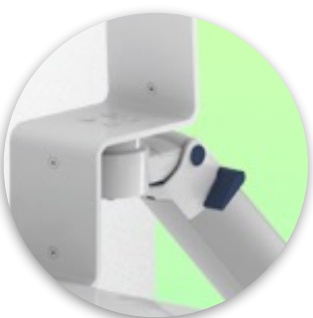

**Mounting Information - Column Slide Rail**

**Part Number: WM 225.181**

**Medical Combo arm Standard adjustable in height by 2 x 300 mm, fixing on table column.  
Supported weight balance scale from 6 to 10 Kg**

**Table column Mount:**

To install this medical arm, you need to use one of our medical columns. These are available in standard heights of 500 and 300 mm. Custom heights are available on request. Slide covers and end caps are supplied with every order.

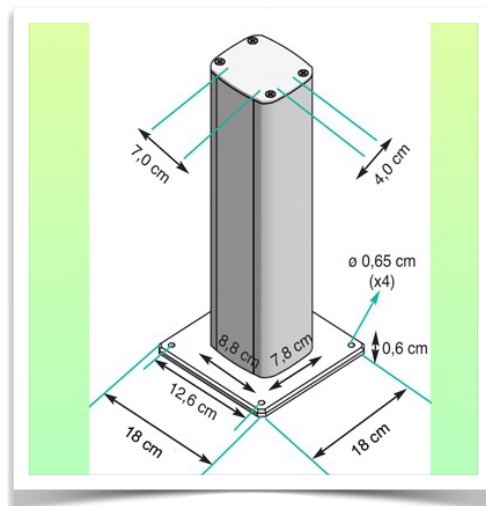
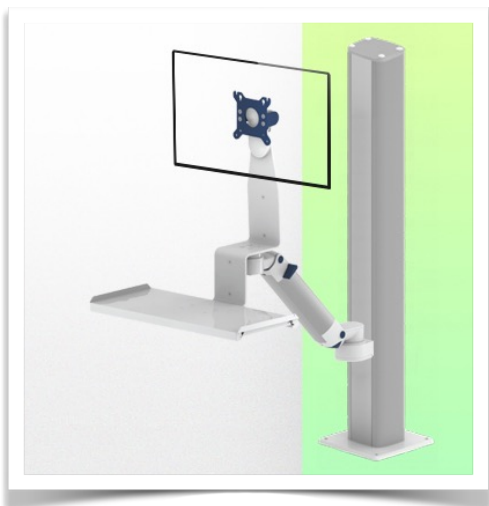

**Mounting Information - Mounting Options**

**Part Number: WM 225.181**

**Medical Combo arm Standard adjustable in height by 2 x 300 mm, fixing on table column.  
Supported weight balance scale from 6 to 10 Kg**

**Where do you want to mount the support arm?**

At the hospital, there are different ways to fix our brackets: round tube, standard rail, wall rail or on an anaesthesia machine. We will always provide you with the adapter you need.



**Adapter for vertical wall slide**  
For wall slide mounting



**Adapter for Amico remote controls and wall panels**



**Adapter for Mindray medical power supply units**



**Double clamp for vertical standard rail**  
For mounting on two parallel vertical standard rails 10 x 25 mm



**Fixed clamp for a standard rail**  
For mounting on a horizontal standard rail 10 x 25, 8 x 35, 10 x 30, 10 x 50 mm



**Fixed clamp for round tube**  
For mounting on round tube  $\varnothing$  25, 35, 38 mm



**Adapter for Maquet anaesthesia machines**  
Cone Adapter for Model FLOW i



**Adapter for Löwenstein anaesthesia machines**  
Medical Adapter for Leon / Leon plus



**Universal round tube clamp**  
V-clamp for mounting on round tube  $\varnothing$  23 - 40 mm





**Mounting Information - Mounting Options**

**Part Number: WM 225.181**

**Medical Combo arm Standard adjustable in height by 2 x 300 mm, fixing on table column.  
Supported weight balance scale from 6 to 10 Kg**

**Where do you want to mount the support arm?**

At the hospital, there are different ways to fix our brackets: round tube, standard rail, wall rail or on an anaesthesia machine. We will always provide you with the adapter you need.

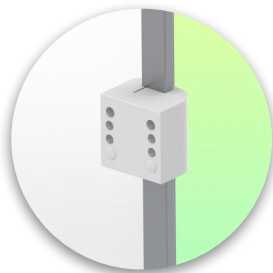

**Clamp for a vertical standard rail**

For mounting on standard rail 10 x 25 mm

**Adapter for anaesthesia machine (all suppliers)**

H 80 mm, with existing side rail

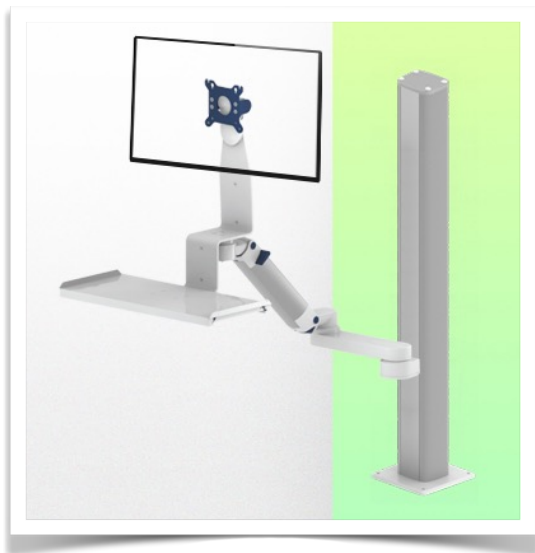

**Product Highlights:**

Height adjustable arms offer full cable integration and easy cleaning for infection control in all critical care areas of the clinical environment. Our 5-year warranty ensures reliable, trouble-free and maintenance-free operation. The swivel function at the point of attachment as well as the tilt and swivel function of the monitor adaptation offer optimal positioning of your device. The height-adjustable arm in its extended version is a two-part arm with a central pivot point between the two arm sections. All bottom mounted monitors have the safety feature of a 20° tilt stop.



Considered to be the world's best in advanced hygiene control, our medical mounting systems include cable integration, a 5-year maintenance-free warranty and medical grade compliance. We're simply the best in the world at what we do.

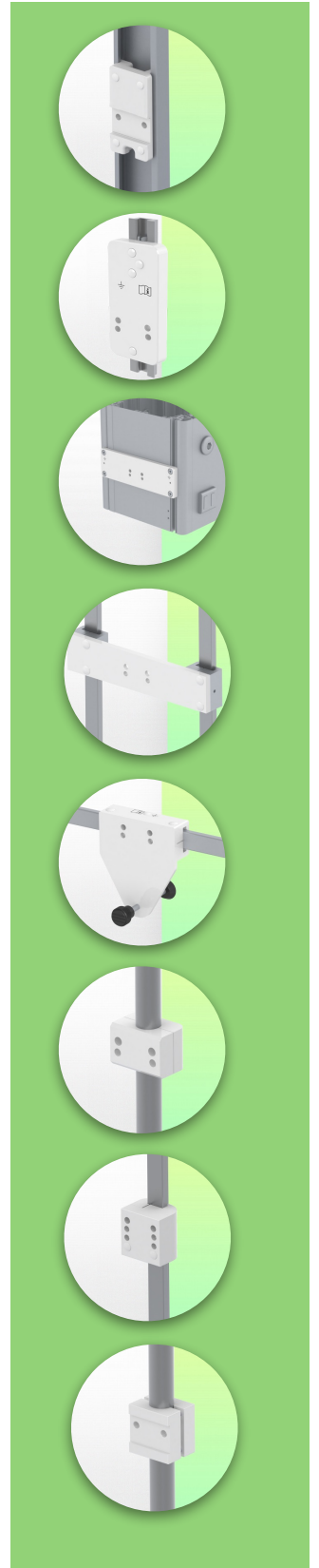

Technical drawing of this Combo configuration

Part Number: WM 225.181

Medical Combo arm Standard adjustable in height by 2 x 300 mm, fixing on table column.  
Supported weight balance scale from 6 to 10 Kg

SIDE VIEW - VUE DE CÔTE - ZIJAANZICHT

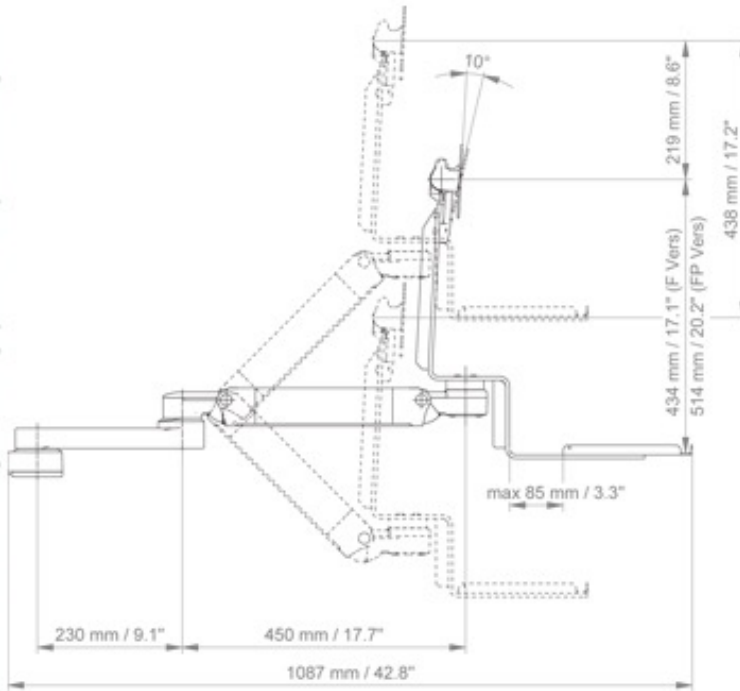

TOP VIEW - VUE DE DESSUS - BOVEN BEKIJKEN

