

Presentation

Part Number: WM 226.101

**Medical Combo 2 x 300 mm swivel arm Foldable for monitor and keyboard,
(weight supported up to 18 Kg), wall mount on vertical slide rail**

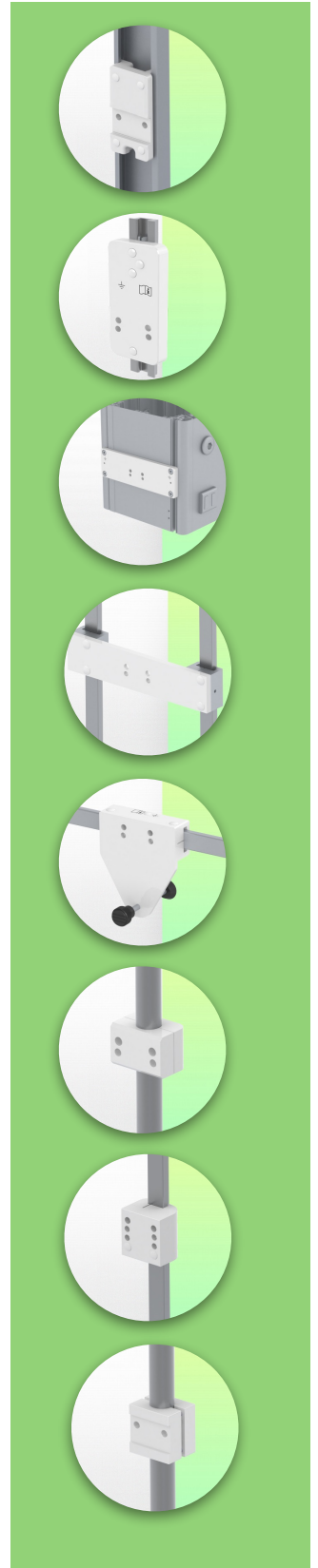
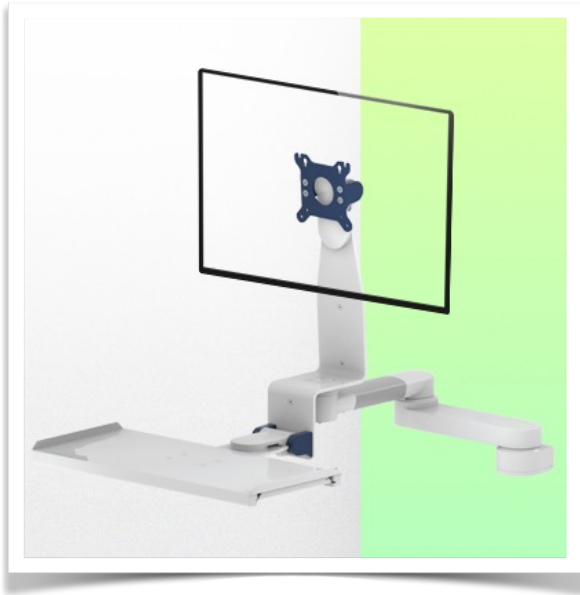

The 2 x 300 mm long Combo Medical Arm Foldable can be used to mount, orientate and adjust a monitor perfectly. The supplied 500 x 202 mm keyboard holder can accommodate a standard keyboard and mouse. As an option, it can be equipped with a stand with a sliding right/left mouse tray with dimensions of 480 x 220 mm for the keyboard and 226 x 220 mm for the mouse or with a large keyboard stand with dimensions of 580 x 200 mm.

Technical specifications:

- * Integrated cable management
- * Standard 500 x 202 mm keyboard support foldable at 90°
- * Optional Vertical Wall Rail mounting, of which several lengths are available (480 mm - 720 mm - 960 mm - 1200 mm). These wall rails can be easily cut to size. All cables are also routed through the wall rail. (See Option on following pages)
- * This 300mm long Combo Arm simply slides into the wall rail and then adjusts to the required height and is fixed. It does not have a height adjustment but does have the ability to rotate.
- * The head of this arm complies with the VESA 75/100mm screen mounting standard.
- * Compatible with equipment weighing up to 18kg.
- * Screen tilt: 10° * Arm rotation: 105° right, 105° left. 180° central rotation
- * Keyboard support rotation: 110° right, 110° left
- * Total length of the configuration 986 mm * Colour RAL 5013 cobalt blue and RAL 9016 traffic white
- * **Warranty: 5 years**

Technical specifications

Part Number: WM 226.101

**Medical Combo 2 x 300 mm swivel arm Foldable for monitor and keyboard,
(weight supported up to 18 Kg), wall mount on vertical slide rail**

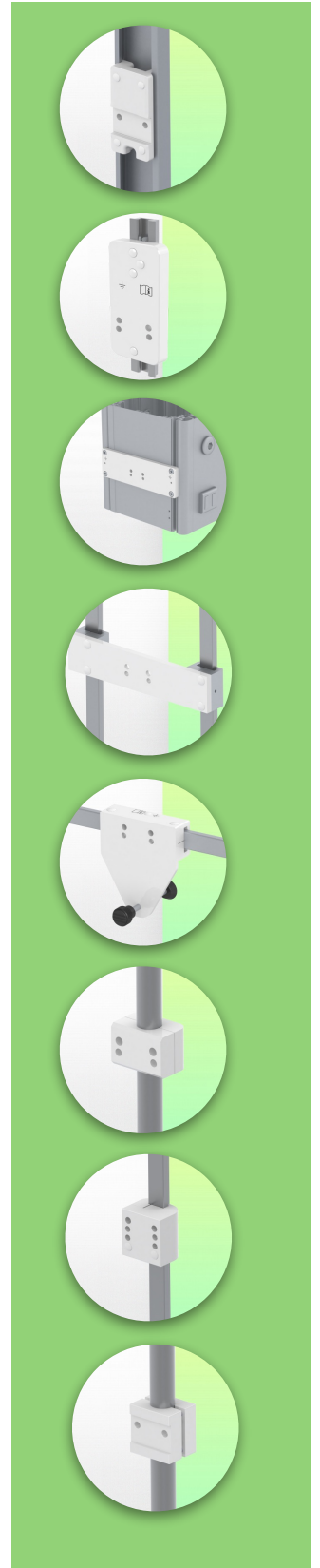
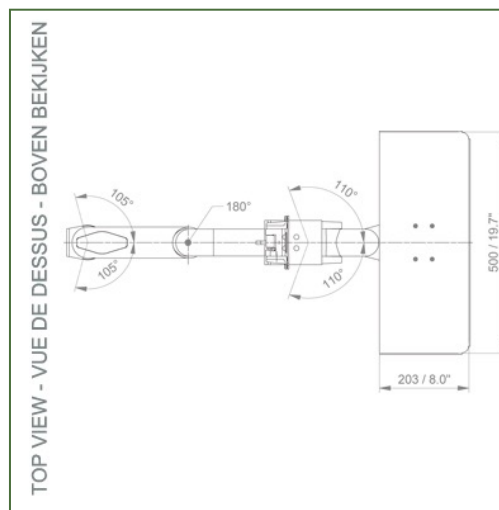
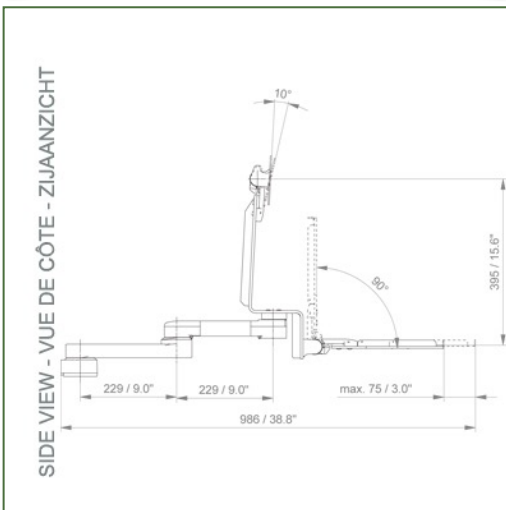

Monitor adaptation: VESA 75/100 mm

Colour: Les pièces décoratives: RAL 5013 cobalt blue

Aluminium parts: RAL 9016 traffic white

Max. load capacity of the support arm: 18 kg

Monitor adaptation Max. load capacity: 18 Kg

Product weight: 4,7 to 6,3 Kg - depending on the size of the keyboard tray

Product highlights:

Non-height adjustable arm. The extended swivel arms and swivel arms provide full cable integration and easy cleaning for infection control in all ICU areas of the clinical environment. Our 5-year warranty guarantees reliable, trouble-free and maintenance-free operation. The swivel function at the attachment point as well as the tilt and swivel function of the monitor adapter provide optimal positioning of your device. The extended swing arm is a two-part arm with a central pivot point between the two sections of the arm. All bottom-mounted monitors have the safety function of a 20° tilt stop.

Mounting Information - Wall Slide Rail

Part Number: WM 226.101

**Medical Combo 2 x 300 mm swivel arm Foldable for monitor and keyboard,
(weight supported up to 18 Kg), wall mount on vertical slide rail**

Wall Slide Rail:

To install this short pivot medical arm, you must either use an existing rail from your facility or order one of our slide rails. These are available in standard lengths of 480 mm, 720 mm, 960 mm and 1200 mm. Custom lengths are available on request. Slide covers and end caps supplied with each order.

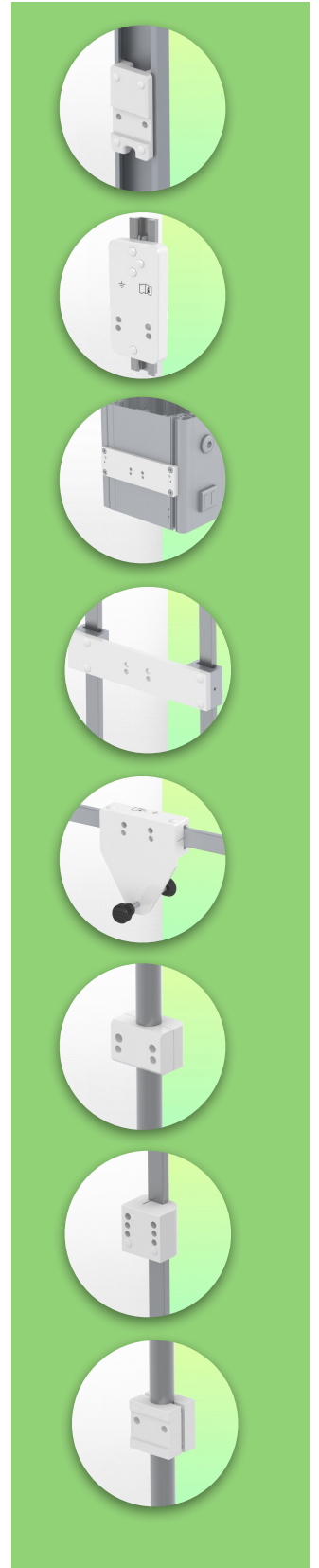
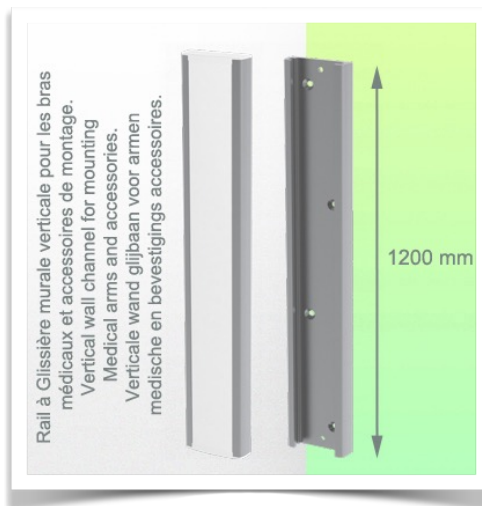
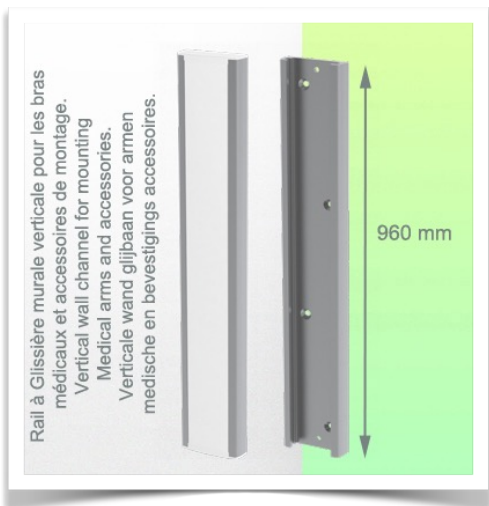
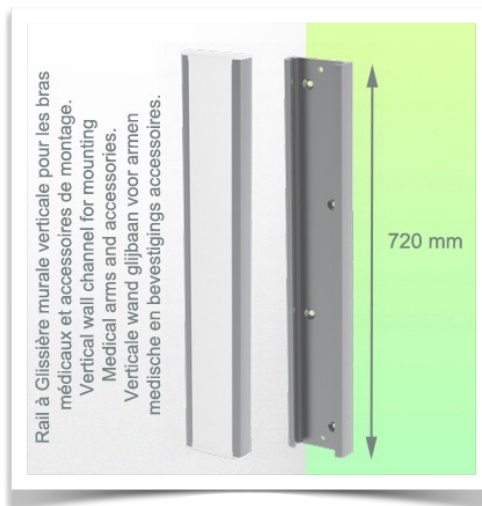
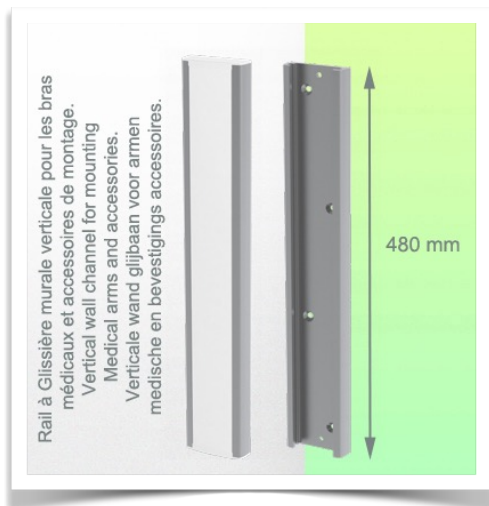

Mounting Information - Mounting Options

Part Number: WM 226.101

**Medical Combo 2 x 300 mm swivel arm Foldable for monitor and keyboard,
(weight supported up to 18 Kg), wall mount on vertical slide rail**

Where do you want to mount the support arm?

At the hospital, there are different ways to fix our brackets: round tube, standard rail, wall rail or on an anaesthesia machine. We will always provide you with the adapter you need.



Adapter for vertical wall slide
For wall slide mounting



Adapter for Amico remote controls and wall panels



Adapter for Mindray medical power supply units



Double clamp for vertical standard rail
For mounting on two parallel vertical standard rails 10 x 25 mm

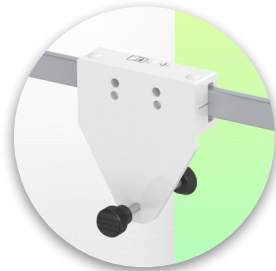

Fixed clamp for a standard rail
For mounting on a horizontal standard rail 10 x 25, 8 x 35, 10 x 30, 10 x 50 mm



Fixed clamp for round tube
For mounting on round tube \varnothing 25, 35, 38 mm



Adapter for Maquet anaesthesia machines
Cone Adapter for Model FLOW i

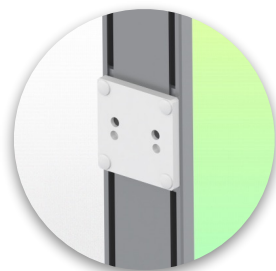

Adapter for Löwenstein anaesthesia machines
Medical Adapter for Leon / Leon plus



Universal round tube clamp
V-clamp for mounting on round tube \varnothing 23 - 40 mm

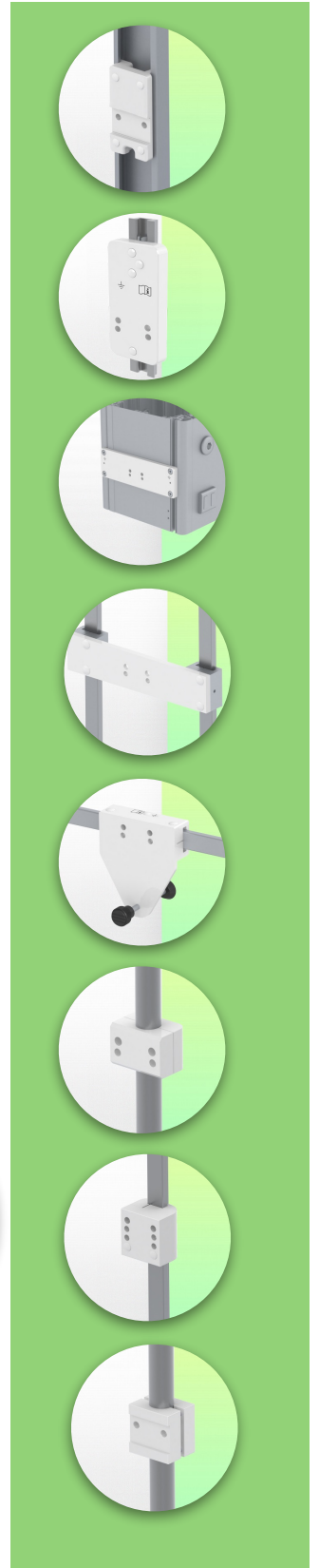

Mounting Information - Mounting Options

Part Number: WM 226.101

**Medical Combo 2 x 300 mm swivel arm Foldable for monitor and keyboard,
(weight supported up to 18 Kg), wall mount on vertical slide rail**

Where do you want to mount the support arm?

At the hospital, there are different ways to fix our brackets: round tube, standard rail, wall rail or on an anaesthesia machine. We will always provide you with the adapter you need.



Adapter for anaesthesia machine (all suppliers)

H 80 mm, with existing side rail

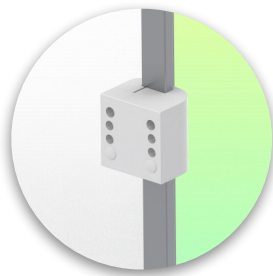

Clamp for a vertical standard rail

For mounting on standard rail 10 x 25 mm

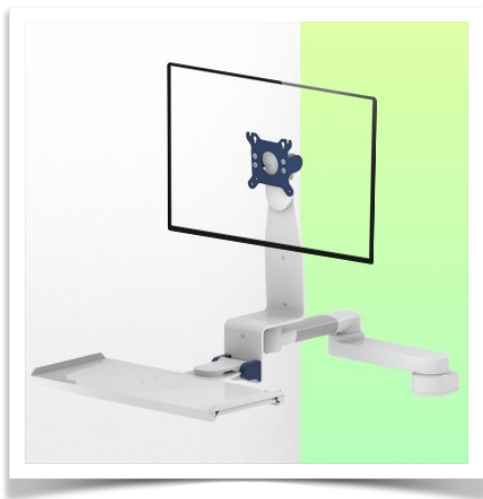

Considered to be the world's best in advanced hygiene control, our medical mounting systems include cable integration, a 5-year maintenance-free warranty and medical grade compliance. We're simply the best in the world at what we do.

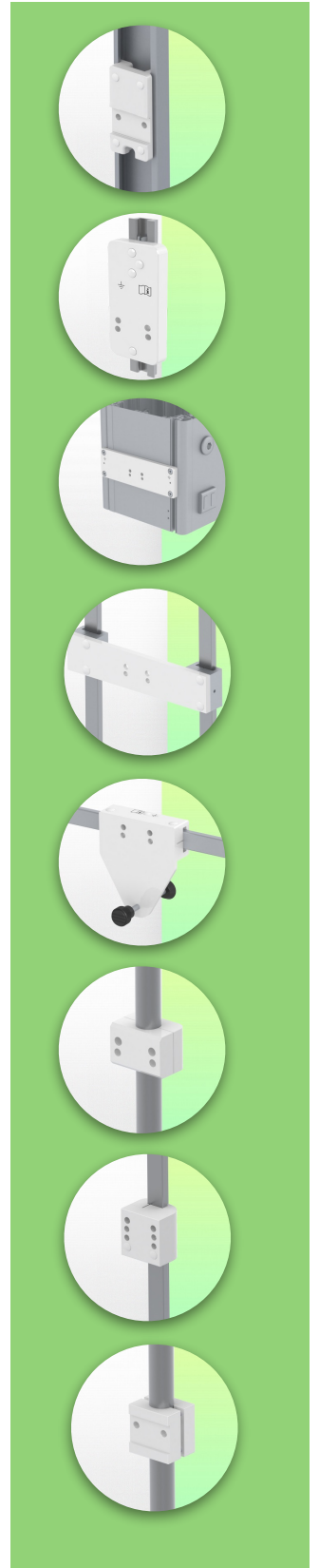

Technical drawing of this Combo configuration

Part Number: WM 226.101

Medical Combo 2 x 300 mm swivel arm Foldable for monitor and keyboard,
(weight supported up to 18 Kg), wall mount on vertical slide rail

SIDE VIEW - VUE DE CÔTE - ZIJAANZICHT

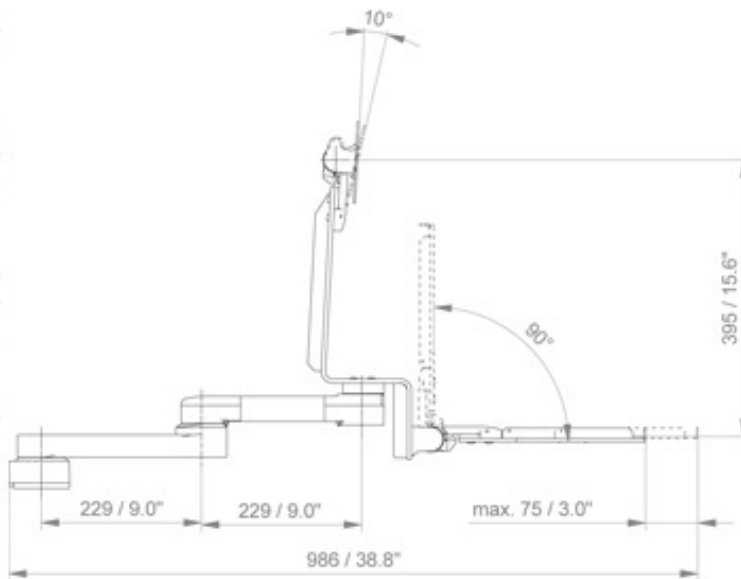

TOP VIEW - VUE DE DESSUS - BOVEN BEKIJKEN

