

Presentation

Part Number: WM 227.131

Medical swivel arm for infusion pump stand 261 mm, For mounting to fixed tube ø 30 mm

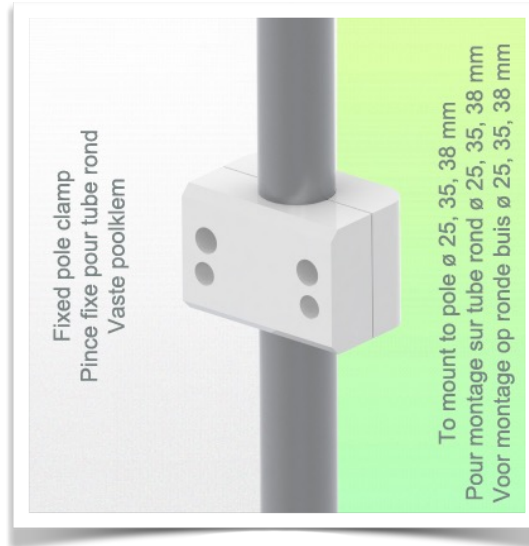

This standard 261mm long infusion pump stand swivel arm allows a 25mm diameter infusion pole or a pole of the same diameter to be fixed, oriented and adjusted perfectly. Optional lengths of 321mm and 421mm are available.

Axis of rotation from mounting: 105° right and 105° left

Maximum supported weight 30 kg including infusion pump.

Technical data:

- * Arm rotation: 105° right, 105° left.
- * Length of the arm 261 mm
- * Weight supported by the arm: 30 Kg
- * Color RAL RAL 9002 grey-white
- * All our medical arms are in conformity: CE, ROHS, Medical Grade, Regulations MDD 93/42 ECC.
- * Fixed tube adapter ø 30 mm included in this configuration
- * Fixing head for 25 mm diameter tube * Warranty: 5 years

(See options for infusion pump stand in the accessories section)

Technical specifications

Part Number: WM 227.131

Medical swivel arm for infusion pump stand 261 mm, For mounting to fixed tube \varnothing 30 mm

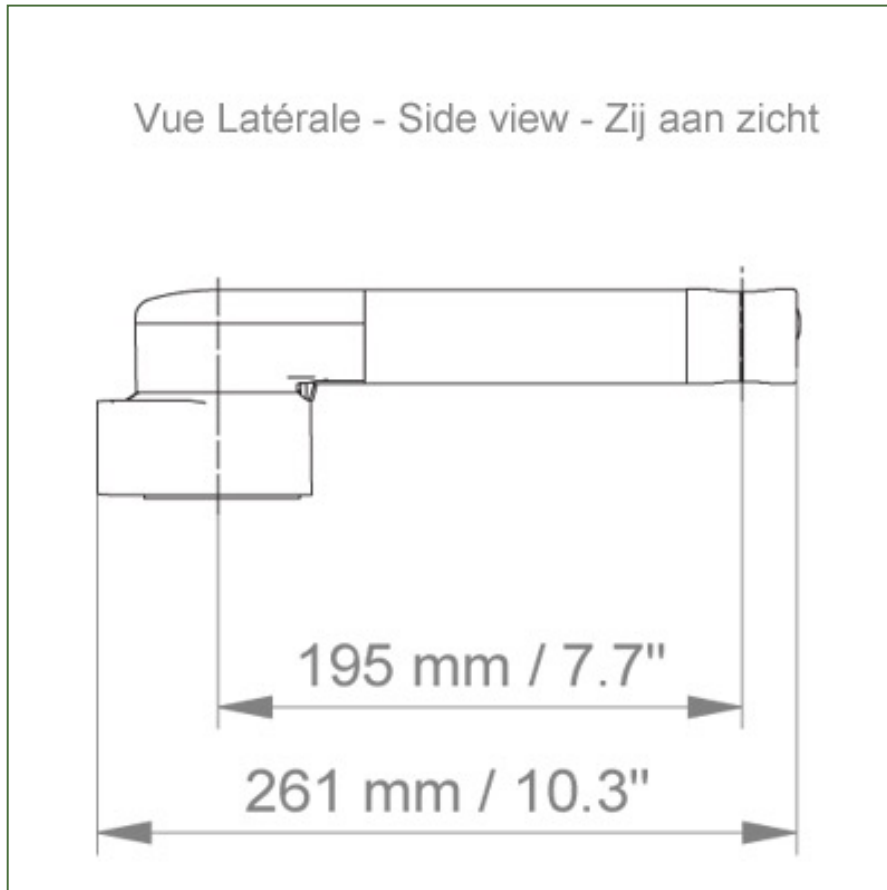

+

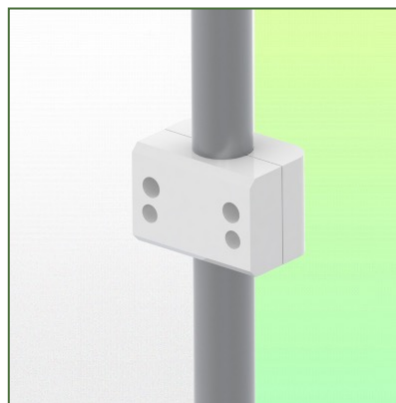

Technical specifications

Part Number: WM 227.131

Medical swivel arm for infusion pump stand 261 mm, For mounting to fixed tube \varnothing 30 mm

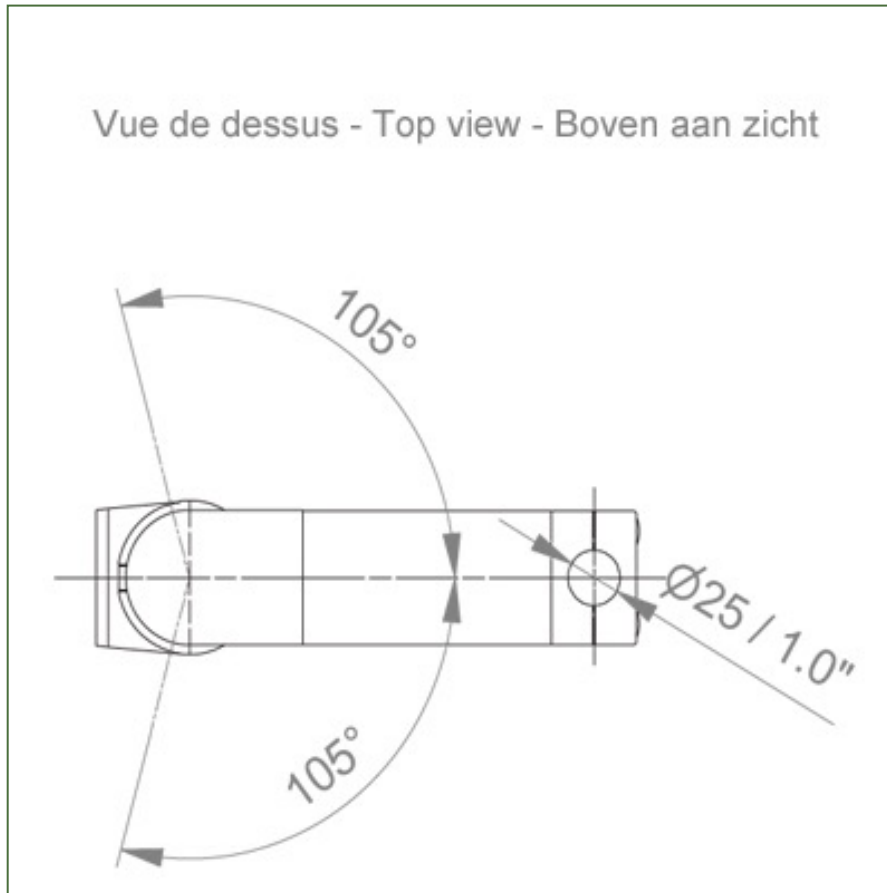

+

