

Presentation

Part Number: WM 227.272

Bar code scanner holder mount for mounting to fixed tube \varnothing 25 mm

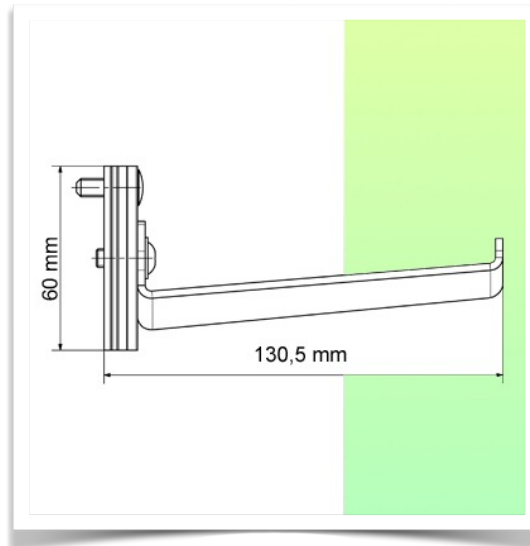
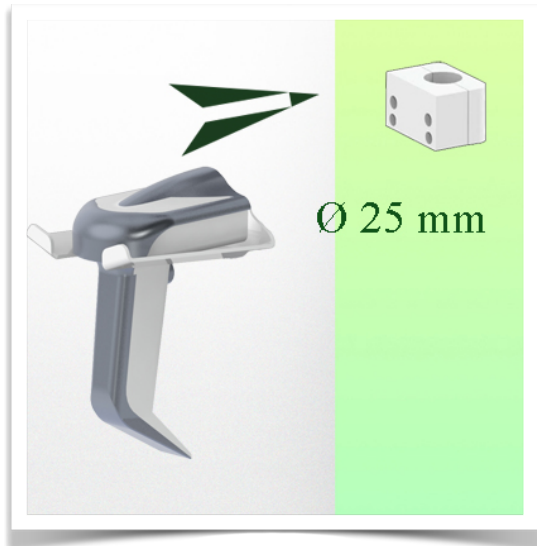

Universal barcode scanner holder.

This universal barcode scanner stand is ideal for keeping the scanner close to the medical facility. This sturdy barcode scanner stand is the perfect storage place where scanning is in application.

Technical specifications

- * Dimensions: 13.5 x 10.31 x 6 cm
- * Bar code scanner holder for mounting to fixed tube \varnothing 25 mm
- * Color: RAL 7034 Graphite Grey
- * 5 year warranty

