

Presentation

Part Number: WM 250.113NK

Double 615 mm Horizontal Medical Arm for monitoring Adaptation for 5" plate and Nihon Kohden Interface, fixing on Din Vertical Rail. Compatible with Nihon Kohden monitoring.

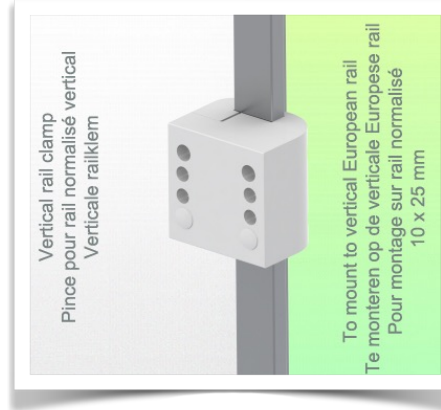
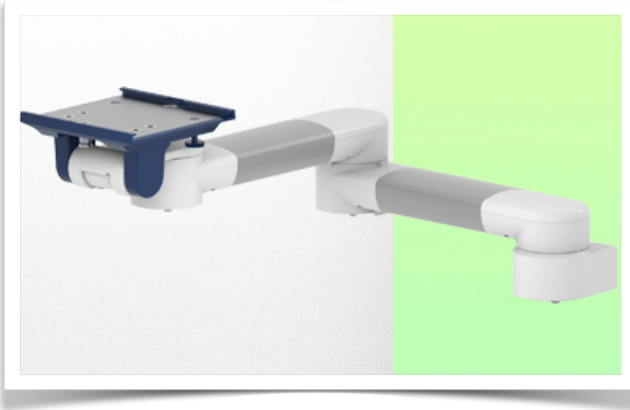

Double 615 mm Horizontal Medical Arm for monitoring Adaptation for 5" plate and Nihon Kohden Interface, fixing on Din Vertical Rail. Compatible with Nihon Kohden monitoring.

This dual 615 mm Vertical Arm allows the monitor to be fixed, oriented and adjusted perfectly. It is coated with an anti-microbial agent for hygiene and cleaning down to the smallest detail. Its modern design has been specially developed for healthcare environments.

Technical specifications:

- * Integral cable management
- * Lightweight application
- * Mounted on Din rail Vertical Universal clamp included
(10 x 25 mm, 8 x 35 mm, 10 x 30 mm, 10 x 50 mm)
- * This medical arm simply attaches to the Din rail Horizontal and then adjusts to the rail and clamped with the two grips. There is no height adjustment.
- * The head of this arm complies with the mounting standard for Nihon Kohden monitors weighing up to 8 kg.
- * Monitor tilt: 20° down and 12° up
- * Monitor rotation: 115° right, 115° left.
- * Arm rotation: 105° right, 105° left.
- * Total length 615 mm
- * Colour RAL 5013 cobalt blue and RAL 9016 traffic white
- * Warranty: 5 years

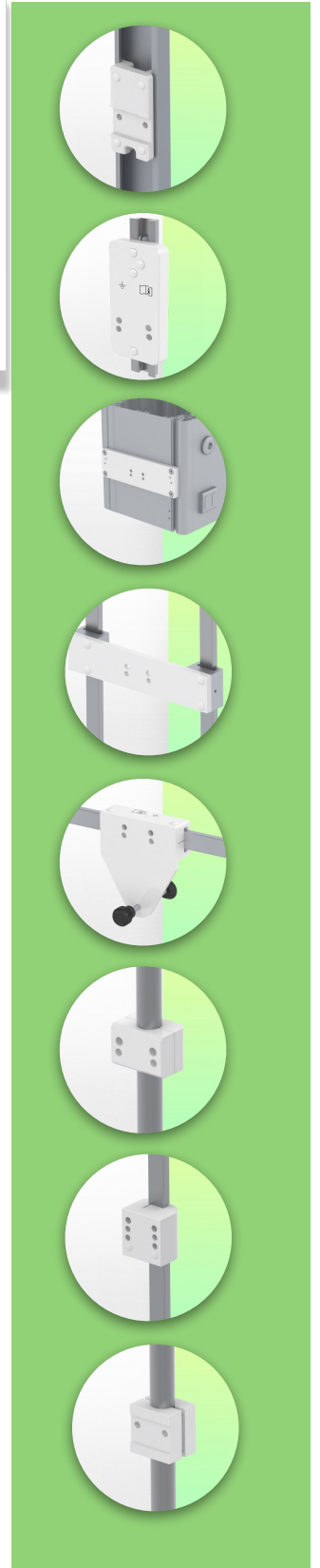

Technical specifications

Part Number: WM 250.113NK

Double 615 mm Horizontal Medical Arm for monitoring Adaptation for 5" plate and Nihon Kohden Interface, fixing on Din Vertical Rail. Compatible with Nihon Kohden monitoring.

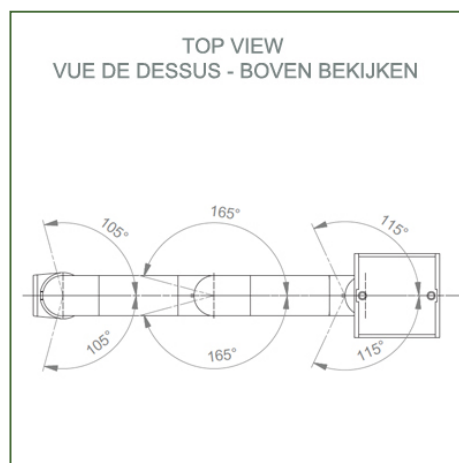
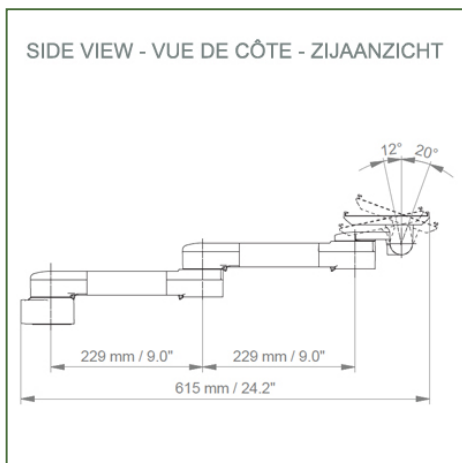
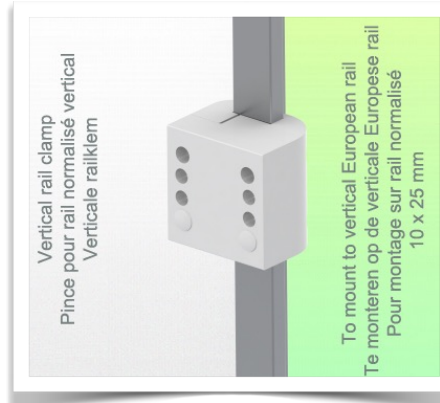
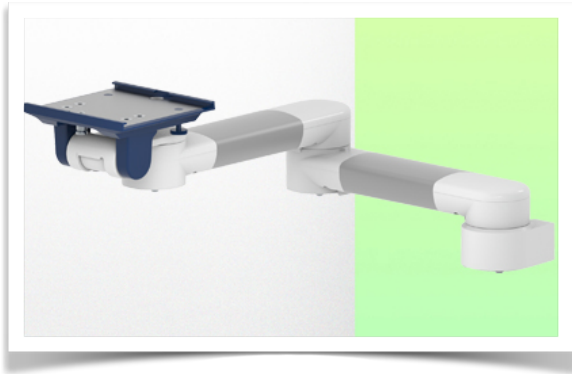

Monitor fitting: 5" Plunge plate
Colour: Decorative parts: RAL 5013 cobalt blue
 Aluminium parts: RAL 9016 traffic white
Max. load capacity of support arm: 8 kg
Monitor fitting max. load: 8 Kg
Product weight: 2,8 Kg

Product strengths:

Non-height-adjustable arm. Swivel arms and extended swivel arms offer full cable integration and easy cleaning for infection control in all critical care areas of the clinical environment. Our 5-year guarantee ensures reliable, trouble-free and maintenance-free operation. The swivel function at the point of attachment and the tilt and swivel function of the monitor adaptation provide optimum positioning of your unit. The extended swivel arm is a two-part arm with a central pivot point between the two arm sections. All bottom-mounted monitors have the safety feature of a 20° tilt stop.

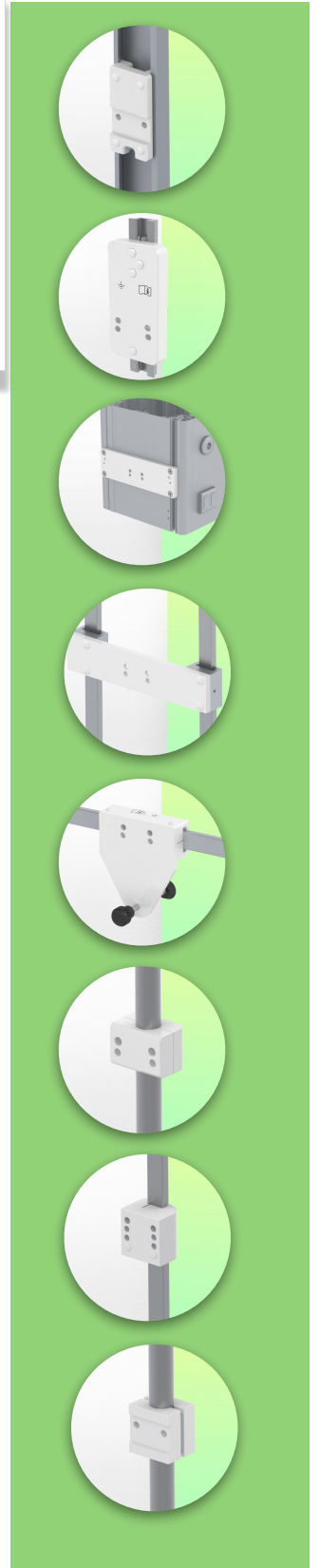

Installation information - Din Rail Vertical standard

Part Number: WM 250.113NK

Double 615 mm Horizontal Medical Arm for monitoring Adaptation for 5" plate and Nihon Kohden Interface, fixing on Din Vertical Rail. Compatible with Nihon Kohden monitoring.

Din Vertical Rail:

Fixed clamp for standard rail For mounting on a vertical standard rail 10 x 25 mm

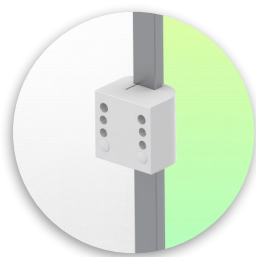
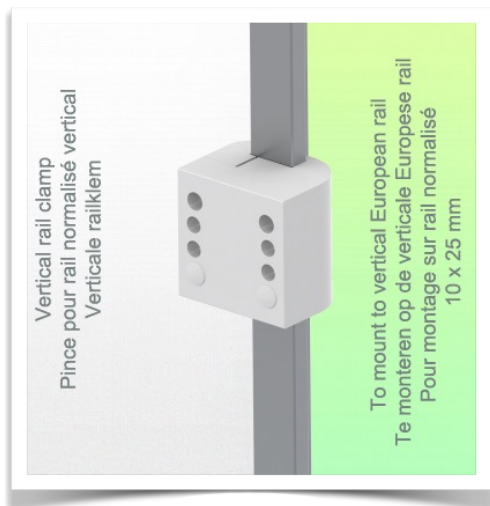

Presentation

Part Number: WM 250.113NK

Double 615 mm Horizontal Medical Arm for monitoring Adaptation for 5" plate and Nihon Kohden Interface, fixing on Din Vertical Rail. Compatible with Nihon Kohden monitoring.

**Adaptateur pour Nihon Kohden
Adapter for Nihon Kohden
Adapter voor Nihon Kohden**

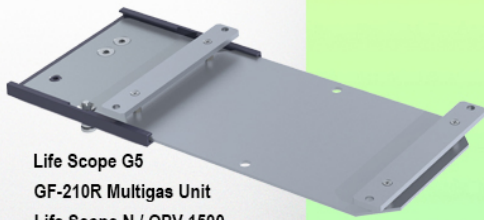

Life Scope G5
GF-210R Multigas Unit
Life Scope N / OPV 1500
Life Scope i / Life Scope L / BSM 2301 / BSM 2303
Vismo PVM 2700 Vismo PVM 4000
Life Scope VS / BSM 3500 / BSM 3700, Vismo PVM 2700
Life Scope A / BSM 5105 / BSM 5135
Life Scope TR / BSM 6301K / BSM 6501K / BSM 6701K



Adaptation with 5" plunger plate

Monitor mounting plates for monitoring

The 5" plunger plate is designed to accommodate bottom-mounted monitors. Please note that a special mounting adapter is required for some monitors. The mounting adapter is installed on the bottom and slides into the 5" immersion plate. For Dräger and GE monitors, a special mounting adapter is not required. For Mindray, Nihon Kohden, Spacelabs and Philips Sure Signs/ Vital Signs monitors, mounting adapters are required. For the Philips IntelliVue series, please refer to the Philips Monitoring IntelliVue Series.

All our medical arms can be equipped with this adaptation, of which you will find some illustrations here.

All height-adjustable arms have a weight capacity of 22 kg. Rear-mounted monitor adapters and horizontally mounted 5" plinths accept a maximum monitor weight of 18 kg. An additional 4 kg can be mounted on a downstand under the front rotating part. Depending on the material and the strength factor, all weight indications have a safety factor of 4 and/or 6 times according to NF 60601-1 regulations. The current IEC 60601-1 standard for medical electrical equipment is the 3rd edition

For customised solutions and MRI applications please contact us

Presentation

Part Number: WM 250.113NK

Double 615 mm Horizontal Medical Arm for monitoring Adaptation for 5" plate and Nihon Kohden Interface, fixing on Din Vertical Rail. Compatible with Nihon Kohden monitoring.

