

**Presentation**

**Part Number: WM 250.125MD**

**Horizontal 592 mm double medical arm for monitoring. Adaptation to 5" plate or Quick Release, Mounting on Amico medical device pendants and headwalls. Mindray compatible.**

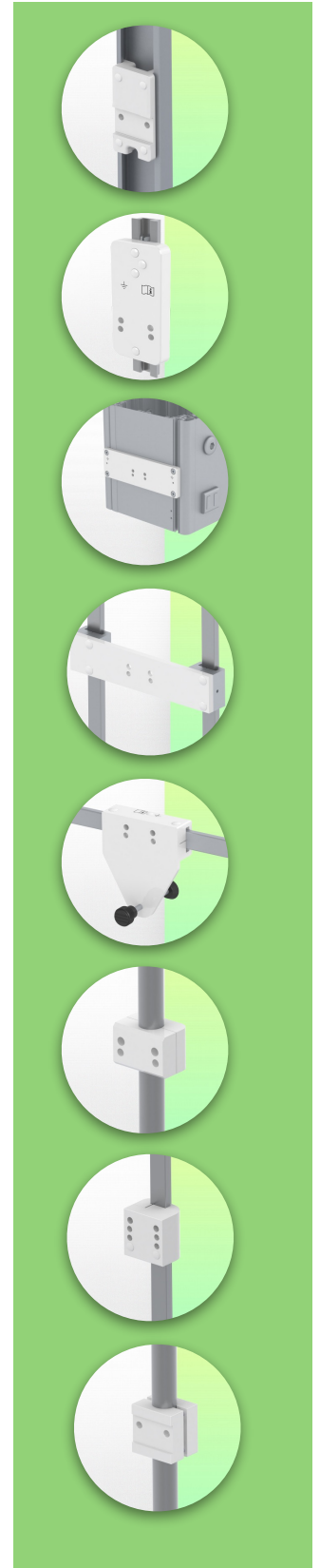
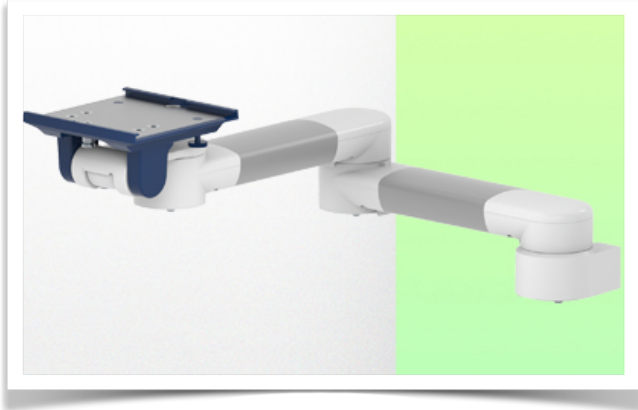

**Horizontal 592 mm double medical arm for monitoring. Adaptation to 5" plate or Quick Release, Mounting on Amico medical device pendants and headwalls. Mindray compatible.**

This 592 mm Horizontal Arm allows you to fix, orient and adjust the monitor perfectly. It is covered with an anti-microbial agent offering hygiene and cleaning in every detail. Its modern design has been specially designed for healthcare environments.

**Technical characteristics:**

- \* Built-in cable passage
- \* For Light Application
- \* Mounting on Amico medical device pendants and headwalls
- \* This 592 mm arm simply attaches to the Amico unit using the adapter and adjusts to the desired height and fixed. It has no height adjustment.
- \* The head of this arm complies with the Mindray Monitor mounting standard, which does not exceed 8 Kg.
- \* Monitor tilt: 16° down and 20° up
- \* Monitor rotation: 115° right, 115° left.
- \* Arm rotation: 105° right, 105° left.
- \* Total length 592 mm
- \* Color RAL 5013 cobalt blue and RAL 9016 traffic white
- \* Warranty: 5 years

## Technical specifications

Part Number: WM 250.125MD

Horizontal 592 mm double medical arm for monitoring. Adaptation to 5" plate or Quick Release, Mounting on Amico medical device pendants and headwalls. Mindray compatible.

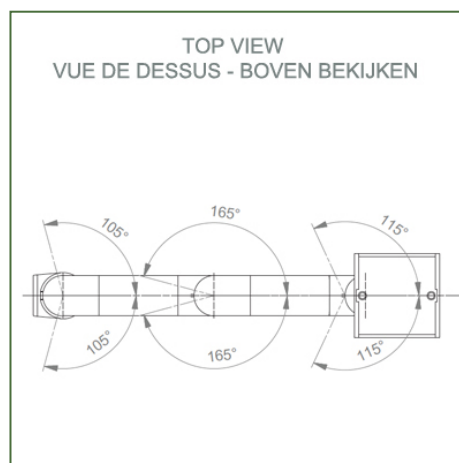
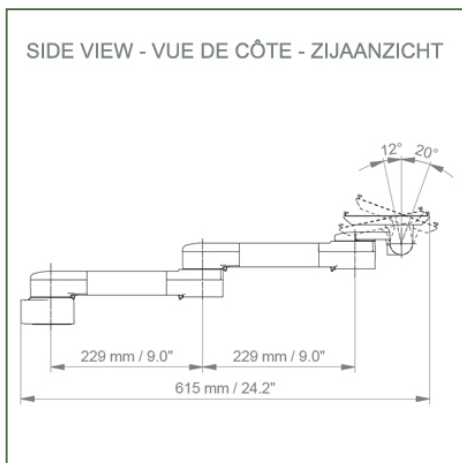
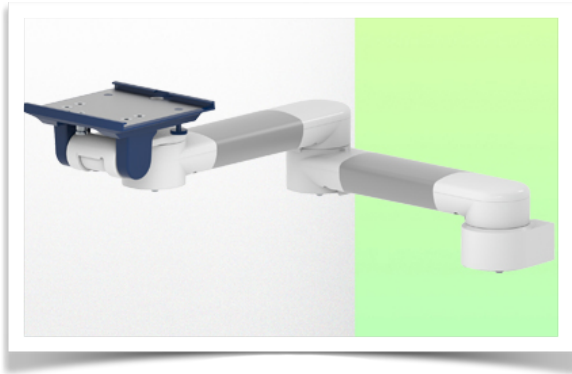

**Monitor adaptation:** Diving plate 5" or Quick Release

**Color: Decorative parts:** RAL 5013 cobalt blue

**Aluminum parts:** RAL 9016 traffic white

**Max load capacity, support arm:** 8 kg

**Max load monitor adaptation:** 8 kg

**Product weight:** 2.8 kg

### Product highlights:

Arm not adjustable in height. The pivoting arms and extended pivoting arms provide complete cable integration and easy cleaning for infection control in all critical care areas of the clinical environment. Our 5-year warranty guarantees reliable, trouble-free and maintenance-free operation. The swivel function at the attachment point as well as the tilt and swivel function of the monitor adaptation provide optimal positioning of your device. The extended swing arm is a two-part arm with a central pivot point between the two arm sections. All monitors mounted at the bottom have the safety function of a 20° tilt stop.



## Mounting information - Adapter Amico

Horizontal 592 mm double medical arm for monitoring. Adaptation to 5" plate or Quick Release, Mounting on Amico medical device pendants and headwalls. Mindray compatible.

### Adapter for Amico pendants & headwalls

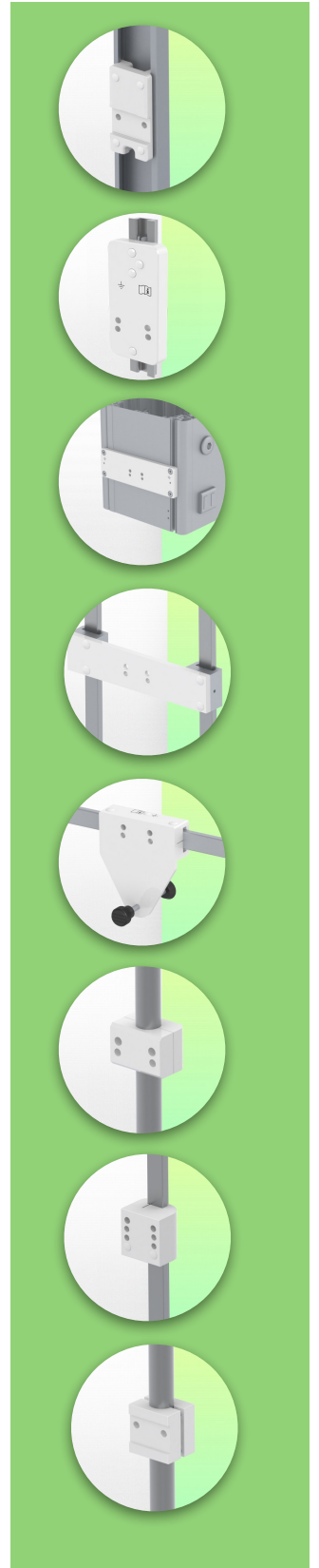

Presentation

Part Number: WM 250.125MD

Horizontal 592 mm double medical arm for monitoring. Adaptation to 5" plate or Quick Release, Mounting on Amico medical device pendants and headwalls. Mindray compatible.

**Mounting adapter 5" Plunge plate**

The 5" plunge plate is suitable for the following Mindray monitors:  
BeneVision series: N12, iMEC, uMEC, iPM, ePM, BeneView series: T5, T8, T9 and VS series VS-600, VS-900, VS 8, VS 9.

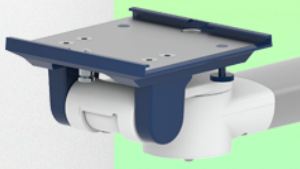

**Mounting adapter (quick release)**

The monitor adaption is prepared to accept the mounting adapter from Mindray and is suitable for the following Mindray monitors: BeneVision series: N12, iMEC, uMEC, iPM, ePM and BeneView series: T5, T8, T9.

