

Presentation

Part Number: WM 250.125NK

Double 615 mm Horizontal Medical Arm for monitoring Adaptation 5" plate and Nihon Kohden Interface, Mounting on Amico pendants and headwalls. Nihon Kohden monitoring compatible.

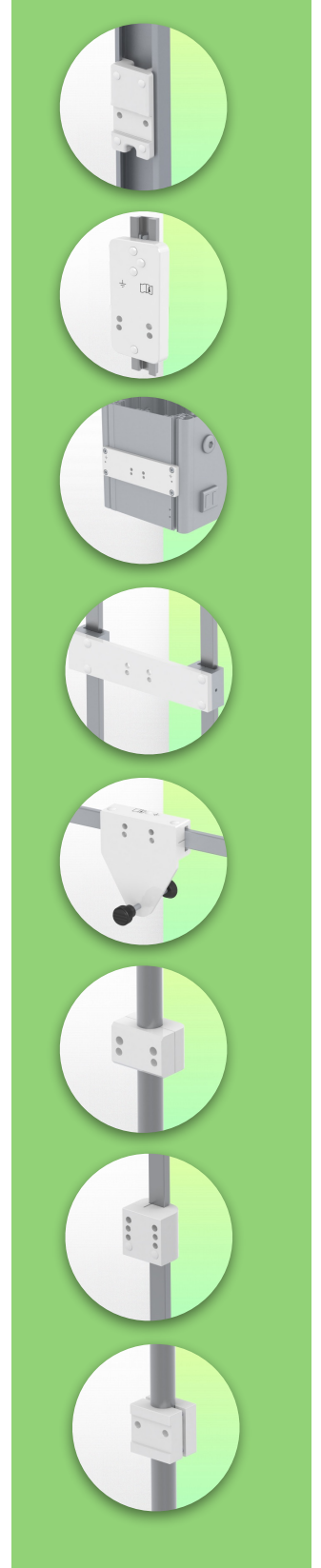
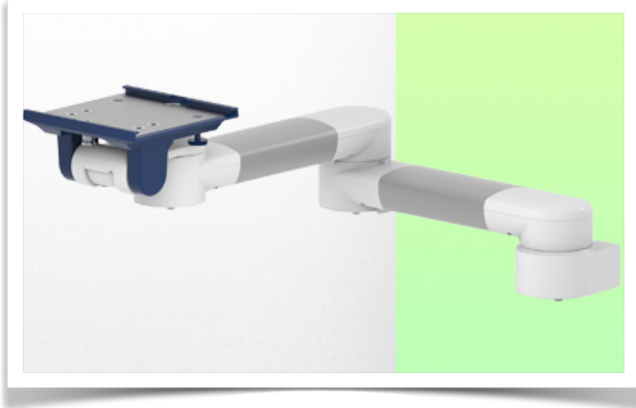

Double 615 mm Horizontal Medical Arm for monitoring Adaptation 5" plate and Nihon Kohden Interface, Mounting on Amico pendants and headwalls. Nihon Kohden monitoring compatible.

This 615 mm Horizontal Arm allows you to fix, orient and adjust the monitor perfectly. It is covered with an anti-microbial agent offering hygiene and cleaning in every detail. Its modern design has been specially designed for healthcare environments.

Technical characteristics:

- * Built-in cable passage
- * For Light Application
- * Mounting on Amico medical device pendants and headwalls
- * This 615 mm arm simply attaches to the Amico unit using the adapter and adjusts to the desired height and fixed. It has no height adjustment.
- * The head of this arm complies with the Nihon Kohden Monitor mounting standard, which does not exceed 8 Kg.
- * Monitor tilt: 20° down and 12° up
- * Monitor rotation: 115° right, 115° left.
- * Arm rotation: 105° right, 105° left.
- * Total length 615 mm
- * Color RAL 5013 cobalt blue and RAL 9016 traffic white
- * Warranty: 5 years

Technical specifications

Part Number: WM 250.125NK

Double 615 mm Horizontal Medical Arm for monitoring Adaptation 5" plate and Nihon Kohden Interface, Mounting on Amico pendants and headwalls. Nihon Kohden monitoring compatible.

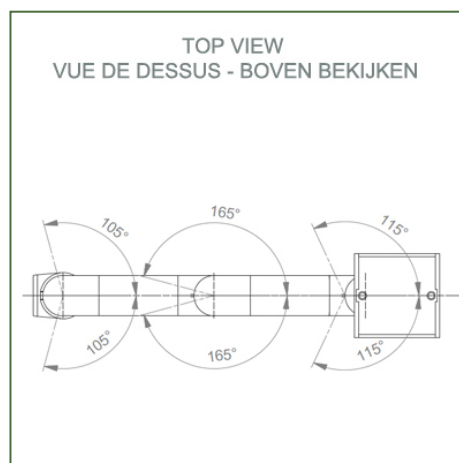
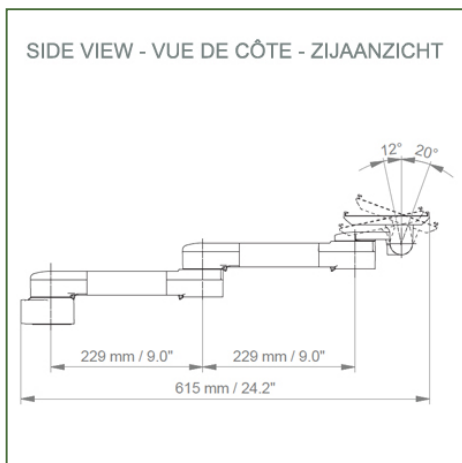
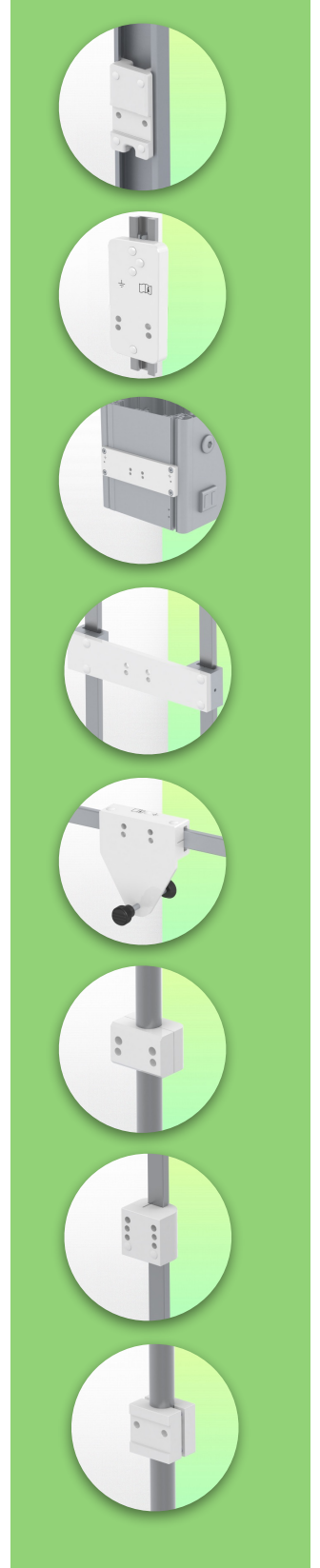
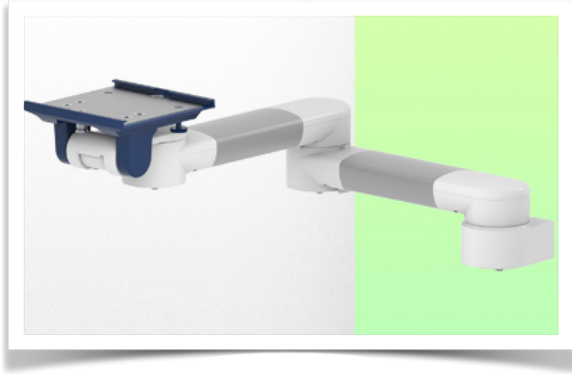

Monitor adaptation: Diving plate 5"
Color: Decorative parts: RAL 5013 cobalt blue
Aluminum parts: RAL 9016 traffic white
Max load capacity, support arm: 8 kg
Max load monitor adaptation: 8 kg
Product weight: 2.8 kg

Product highlights:

Arm not adjustable in height. The pivoting arms and extended pivoting arms provide complete cable integration and easy cleaning for infection control in all critical care areas of the clinical environment. Our 5-year warranty guarantees reliable, trouble-free and maintenance-free operation. The swivel function at the attachment point as well as the tilt and swivel function of the monitor adaptation provide optimal positioning of your device. The extended swing arm is a two-part arm with a central pivot point between the two arm sections. All monitors mounted at the bottom have the safety function of a 20° tilt stop.

Mounting information - Adapter Amico

Part Number: WM 250.125NK

Double 615 mm Horizontal Medical Arm for monitoring Adaptation 5" plate and Nihon Kohden Interface, Mounting on Amico pendants and headwalls. Nihon Kohden monitoring compatible.

Adapter for Amico pendants & headwalls

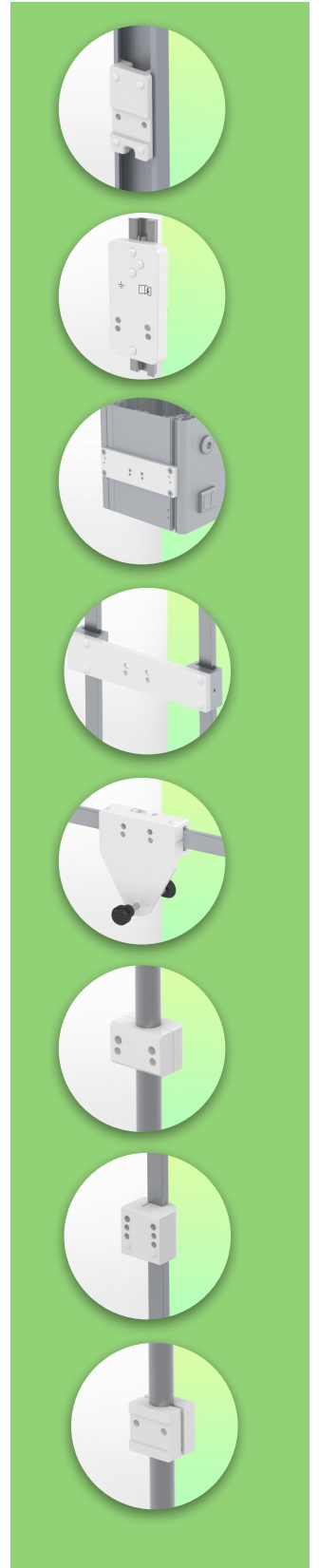

Presentation

Part Number: WM 250.125NK

Double 615 mm Horizontal Medical Arm for monitoring Adaptation 5" plate and Nihon Kohden Interface, Mounting on Amico pendants and headwalls. Nihon Kohden monitoring compatible.

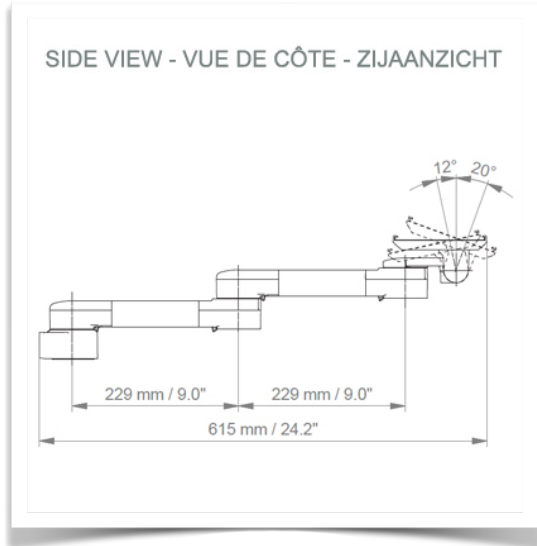

Adaptation with 5" plunger plate

Monitor mounting plates for monitoring

The 5" plunger plate is designed to accommodate bottom-mounted monitors. Please note that a special mounting adapter is required for some monitors. The mounting adapter is installed on the bottom and slides into the 5" immersion plate. For Dräger and GE monitors, a special mounting adapter is not required. For Mindray, Nihon Kohden, Spacelabs and Philips Sure Signs/ Vital Signs monitors, mounting adapters are required. For the Philips IntelliVue series, please refer to the Philips Monitoring IntelliVue Series.

All our medical arms can be equipped with this adaptation, of which you will find some illustrations here.

All height-adjustable arms have a weight capacity of 22 kg. Rear-mounted monitor adapters and horizontally mounted 5" plinths accept a maximum monitor weight of 18 kg. An additional 4 kg can be mounted on a downstand under the front rotating part. Depending on the material and the strength factor, all weight indications have a safety factor of 4 and/or 6 times according to NF 60601-1 regulations. The current IEC 60601-1 standard for medical electrical equipment is the 3rd edition

For customised solutions and MRI applications please contact us

Presentation

Part Number: WM 250.125NK

Double 615 mm Horizontal Medical Arm for monitoring Adaptation 5" plate and Nihon Kohden Interface, Mounting on Amico pendants and headwalls. Nihon Kohden monitoring compatible.

