

**Presentation**

**Part Number: WM 250.131**

**Medical arm with 5" plunge plate for height-adjustable monitoring, wall-mounted on vertical sliding rail. Supported weight balance scale from 4 to 9 kg. Compatible with Dräger and GE monitoring.**

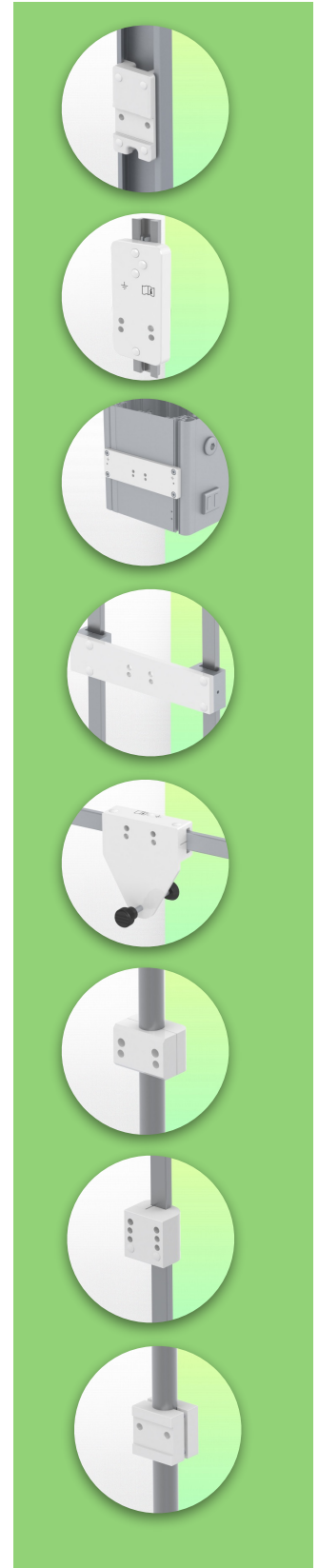
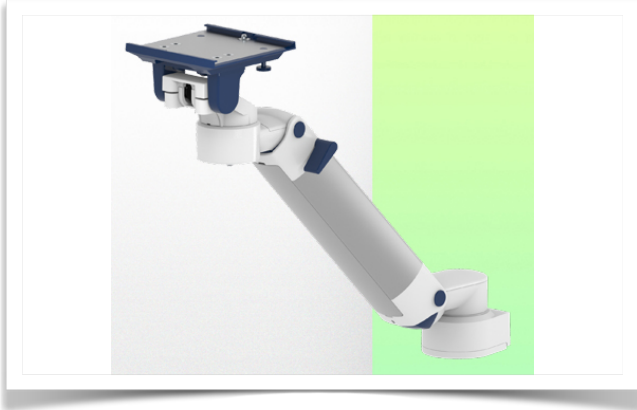

**Medical arm with 5" plunge plate for height-adjustable monitoring, wall-mounted on vertical sliding rail. Supported weight balance scale from 4 to 9 kg. Compatible with Dräger and GE monitoring.**

Full cable integration and infection prevention thanks to easy-to-clean surfaces make this arm ideal for emergency care areas. Height adjustment for ergonomic, customised positioning of the monitor. This 450 mm Horizontal Medical Arm with gas-lift height adjustment enables the monitor to be fixed, oriented and adjusted perfectly. It is coated with an anti-microbial agent for hygiene and cleaning down to the smallest detail. Its modern design has been specially developed for healthcare environments.

**Technical specifications:**

\* Integral cable entry \* Equipotential bonding \* Optional Vertical Wall Slide Rail mounting, of which several lengths are available (480 mm - 720 mm - 960 mm - 1200 mm). These wall rails can be easily cut to size. All cables also run through the wall rail. (See Options on the following pages) \* This 450 mm gas-pressurised Horizontal Arm simply slides into the wall rail, then adjusts to the required height and locks in place. It has a safety stop button for height adjustment, allowing the arm to remain in the chosen position. \* The head of this arm has a 5" Plunge Plate and is compatible with Dräger and GE monitors. \* Suitable for monitors weighing up to 4-9 Kg. \* Monitor tilt: 21° down and 20° up \* Monitor rotation: 115° right, 115° left. \* Arm rotation: 105° right, 105° left \* Height adjustment: 438 mm \* Total length: 589 mm \* All our medical arms comply with CE, ROHS, Medical Grade, Regulations MDD 93/42 ECC. \* Colour: RAL 5013 cobalt blue and RAL 9016 traffic white \* Warranty: 5 years

## Technical specifications

Part Number: WM 250.131

Medical arm with 5" plunge plate for height-adjustable monitoring, wall-mounted on vertical sliding rail. Supported weight balance scale from 4 to 9 kg. Compatible with Dräger and GE monitoring.

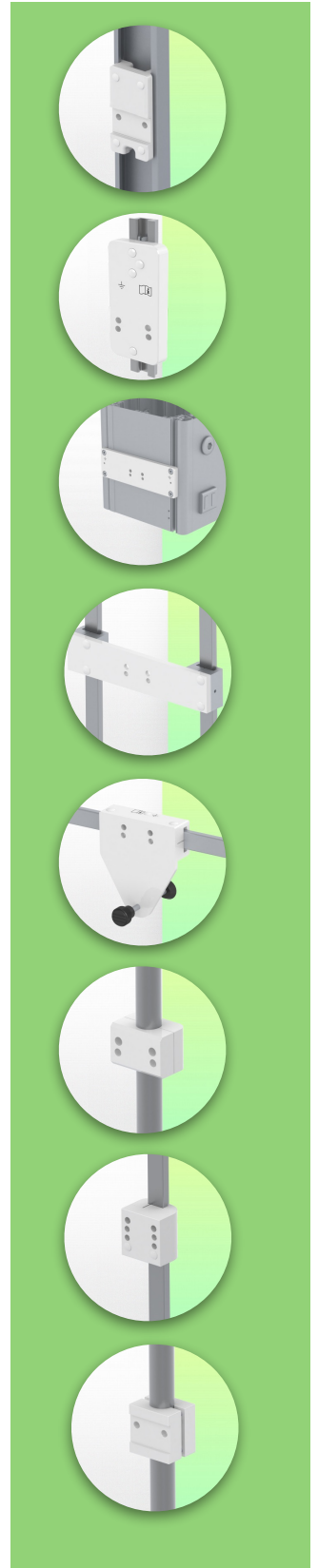

SIDE VIEW - VUE DE CÔTE - ZIJAAZICHT

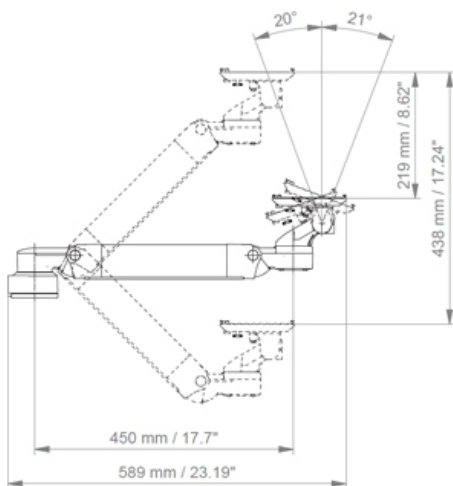

TOP VIEW  
VUE DE DESSUS - BOVEN BEKIJKEN

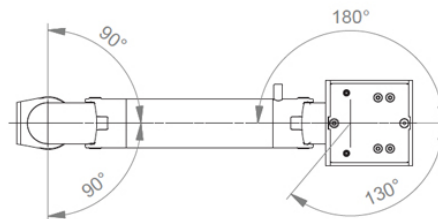

**Monitor adaptation:** 5" Plunge Plate

**Height adjustment:** Slow-release spring, parallel adapter for constant viewing angle

**Colour:** Decorative parts: RAL 5013 cobalt blue

**Aluminium parts:** RAL 9016 traffic white

**Max. load capacity:** 22 kg

**Monitor adaptation max. load:** 18 Kg

**Balance scale on this medical arm:** 4 - 9 Kg

**Product weight:** 3.8 Kg

**Safety:** Has a safety stop button for height adjustment, which allows the medical arm to remain in the chosen position.

**Compatibility:** Monitoring Dräger and GE

**Presentation**

**Part Number: WM 250.131**

Medical arm with 5" plunge plate for height-adjustable monitoring, wall-mounted on vertical sliding rail. Supported weight balance scale from 4 to 9 kg. Compatible with Dräger and GE monitoring.

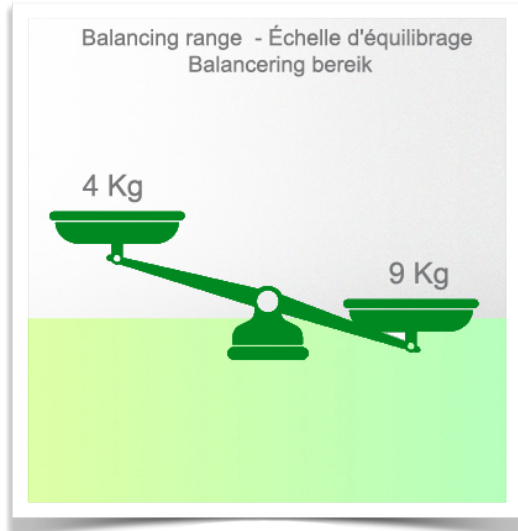
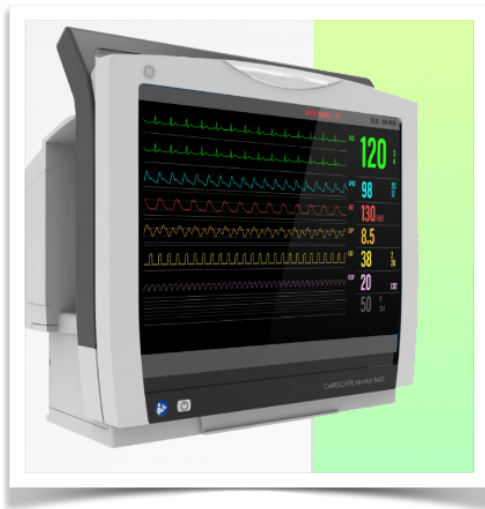

**Installation information - Wall-mounted slide rail**

**Part Number: WM 250.131**

**Medical arm with 5" plunge plate for height-adjustable monitoring, wall-mounted on vertical sliding rail. Supported weight balance scale from 4 to 9 kg. Compatible with Dräger and GE monitoring.**

**Wall-mounted slide rail:**

To install this medical arm, you must either use an existing rail in your installation or order one of our slide rails. These are available in standard lengths of 480mm, 720mm, 960mm and 1200mm. Custom lengths are available on request. Slide covers and end caps are supplied with every order.

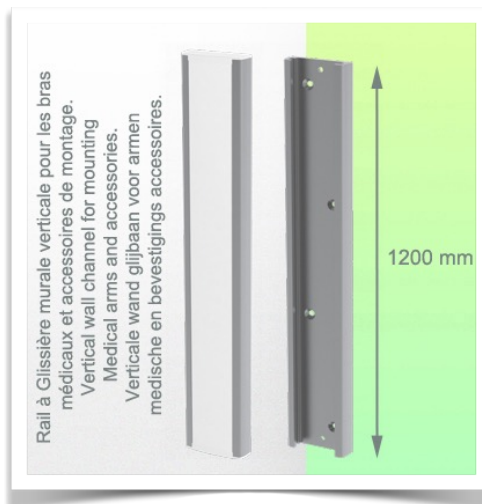
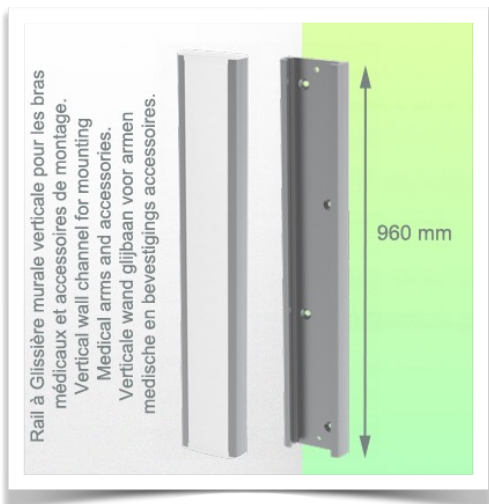
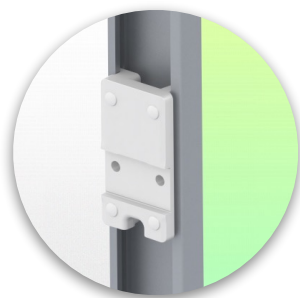
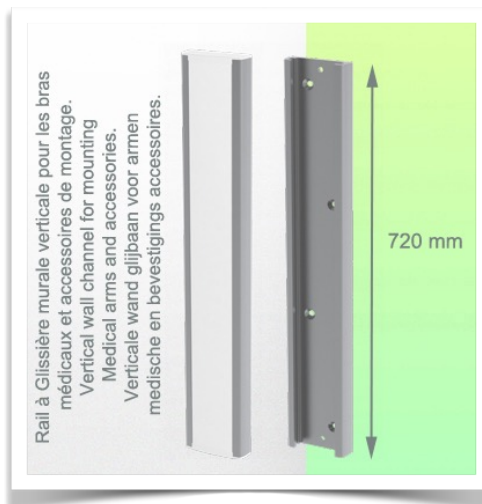
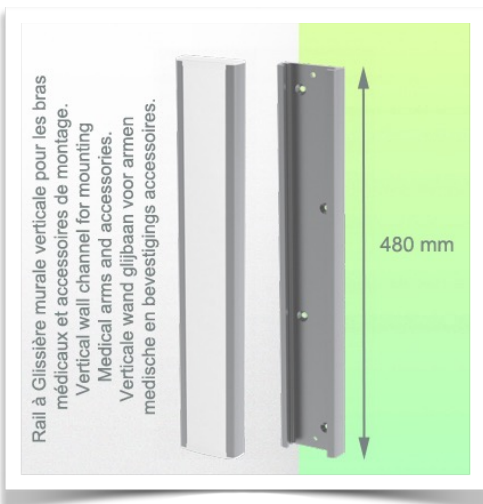

**Presentation**

**Part Number: WM 250.131**

**Medical arm with 5" plunge plate for height-adjustable monitoring, wall-mounted on vertical sliding rail. Supported weight balance scale from 4 to 9 kg. Compatible with Dräger and GE monitoring.**

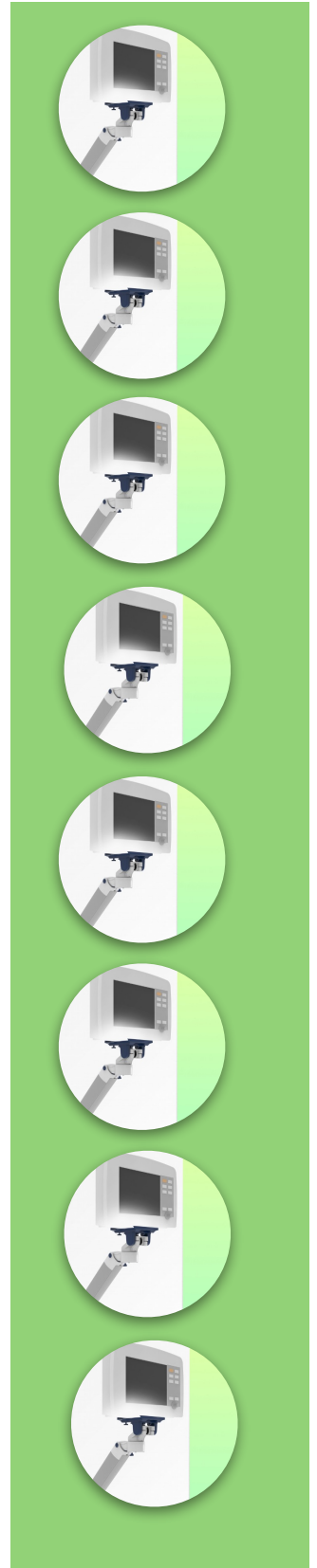

**Adaptation with 5" plunger plate**

**Monitor mounting plates for monitoring**

The 5" plunger plate is designed to accommodate bottom-mounted monitors. Please note that a special mounting adapter is required for some monitors. The mounting adapter is installed on the bottom and slides into the 5" immersion plate. For Dräger and GE monitors, a special mounting adapter is not required. For Mindray, Nihon Kohden, Spacelabs and Philips Sure Signs/ Vital Signs monitors, mounting adapters are required. For the Philips IntelliVue series, please refer to the Philips Monitoring IntelliVue Series.

All our medical arms can be equipped with this adaptation, of which you will find some illustrations here.

All height-adjustable arms have a weight capacity of 22 kg. Rear-mounted monitor adapters and horizontally mounted 5" plinths accept a maximum monitor weight of 18 kg. An additional 4 kg can be mounted on a downstand under the front rotating part. Depending on the material and the strength factor, all weight indications have a safety factor of 4 and/or 6 times according to NF 60601-1 regulations. The current IEC 60601-1 standard for medical electrical equipment is the 3rd edition

For customised solutions and MRI applications please contact us

**Presentation**

**Part Number: WM 250.131**

**Medical arm with 5" plunge plate for height-adjustable monitoring, wall-mounted on vertical sliding rail. Supported weight balance scale from 4 to 9 kg. Compatible with Dräger and GE monitoring.**

