

**Presentation**

**Part Number: WM 250.142MD**

**Medical arm with 5" plunge plate of Quick Release for height-adjustable monitoring, table column mount. Supported weight balance scale from 7,5 to 13 kg. Compatible with Mindray monitoring.**



Cette colonne possède deux rails de fixation pour les différents éléments qui y seront fixés. (1 rail à l'avant de la colonne, 1 rail à l'arrière)

This column has two fixing rails for the different elements that will be fixed to it (1 rail at the front of the column, 1 rail at the back)

Deze zuil heeft twee bevestigingsrails voor de verschillende elementen die eraan bevestigd zullen worden (1 rail aan de voorkant van de zuil, 1 rail aan de achterkant)



**Medical arm with 5" plunge plate of Quick Release for height-adjustable monitoring, table column mount. Supported weight balance scale from 7,5 to 13 kg. Compatible with Mindray monitoring.**

Full cable integration and infection prevention thanks to easy-to-clean surfaces make this arm ideal for emergency care areas. Height adjustment for ergonomic, customised positioning of the monitor. This 569 mm Horizontal Medical Arm with gas-lift height adjustment enables the monitor to be fixed, oriented and adjusted perfectly. It is coated with an anti-microbial agent for hygiene and cleaning down to the smallest detail. Its modern design has been specially developed for healthcare environments.

**Technical specifications:**

- \* Integral cable entry
- \* Equipotential bonding
- \* Optional Table columns are available in various heights (300 - 500 mm). These columns can be easily cut to size. All cables are also routed through the column. (See Option on the following pages)
- \* This 450 mm gas-pressurised Horizontal Arm simply slides into the column rail, then adjusts to the required height and locks in place. It has a safety stop button for height adjustment, allowing the arm to remain in the chosen position.
- \* The head of this arm has a 5" Plunge Plate of Quick Release and is compatible with Mindray monitors.
- \* Suitable for monitors weighing up to 7,5-13 Kg.
- \* Monitor tilt: 23° down and 18° up
- \* Monitor rotation: 180° right, 130° left.
- \* Arm rotation: 90° right, 90° left
- \* Height adjustment: 438 mm
- \* Total length: 569 mm
- \* All our medical arms comply with CE, ROHS, Medical Grade, Regulations MDD 93/42 ECC.
- \* Colour: RAL 5013 cobalt blue and RAL 9016 traffic white
- \* Warranty: 5 years

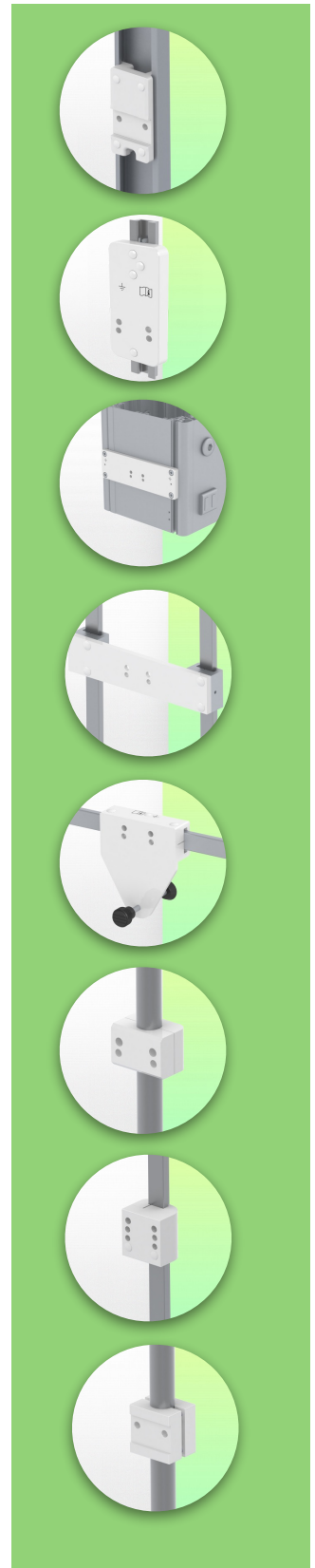

## Technical specifications

Part Number: WM 250.142MD

Medical arm with 5" plunge plate of Quick Release for height-adjustable monitoring, table column mount. Supported weight balance scale from 7,5 to 13 kg. Compatible with Mindray monitoring.



Cette colonne possède deux rails de fixation pour les différents éléments qui y seront fixés. (1 rail à l'avant de la colonne, 1 rail à l'arrière)

This column has two fixing rails for the different elements that will be fixed to it (1 rail at the front of the column, 1 rail at the back)

Deze zuil heeft twee bevestigingsrails voor de verschillende elementen die eraan bevestigd zullen worden (1 rail aan de voorkant van de zuil, 1 rail aan de achterkant)

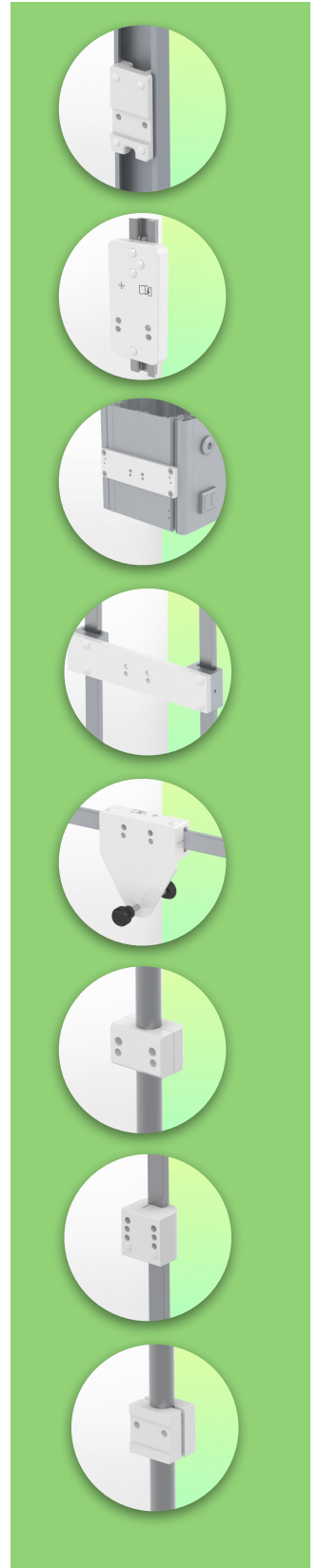

SIDE VIEW - VUE DE CÔTE - ZIJAAZICHT

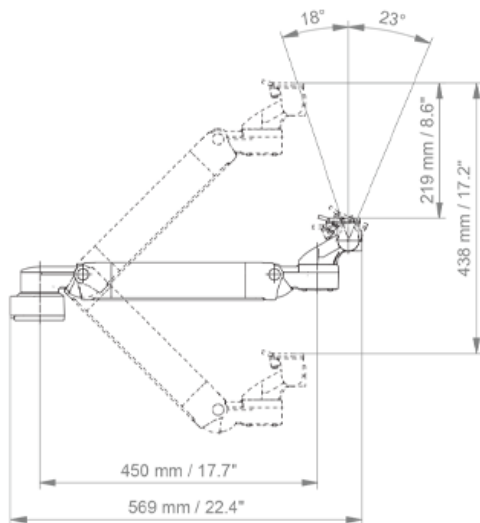

TOP VIEW  
VUE DE DESSUS - BOVEN BEKIJKEN

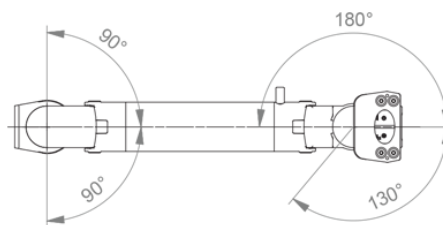

**Monitor adaptation:** 5" Plunge Plate of Quick Release

**Height adjustment:** Slow-release spring, parallel adapter for constant viewing angle

**Colour:** Decorative parts: RAL 5013 cobalt blue

**Aluminium parts:** RAL 9016 traffic white

**Max. load capacity:** 22 kg

**Monitor adaptation max. load:** 18 Kg

**Balance scale on this medical arm:** 7,5 - 13 Kg

**Product weight:** 3.8 Kg

**Safety:** Has a safety stop button for height adjustment, which allows the medical arm to remain in the chosen position.

**Compatibility:** Monitoring Mindray

**Presentation**

**Part Number: WM 250.142MD**

Medical arm with 5" plunge plate of Quick Release for height-adjustable monitoring, table column mount. Supported weight balance scale from 7,5 to 13 kg. Compatible with Mindray monitoring.



**Installation information - Column Slide Rail**

**Part Number: WM 250.142MD**

**Medical arm with 5" plunge plate of Quick Release for height-adjustable monitoring, table column mount. Supported weight balance scale from 7,5 to 13 kg. Compatible with Mindray monitoring.**

**Table column:**

To install this medical arm, you need to use one of our medical columns. These are available in standard heights of 500 and 300 mm. Custom heights are available on request. Slide covers and end caps are supplied with every order.

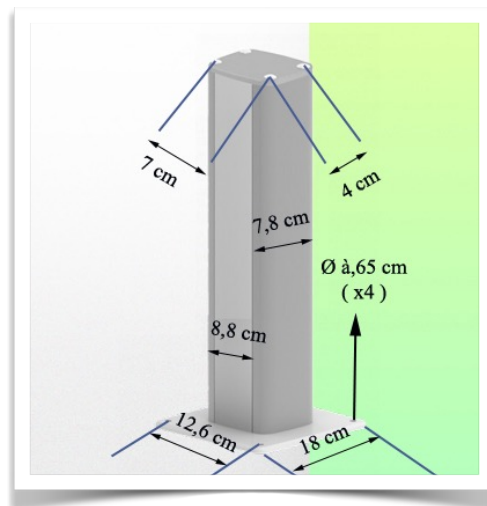
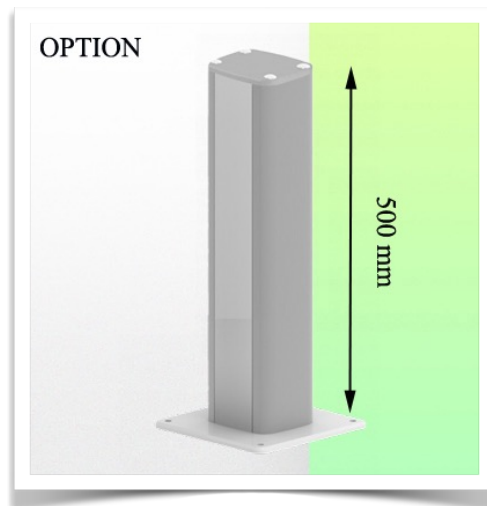
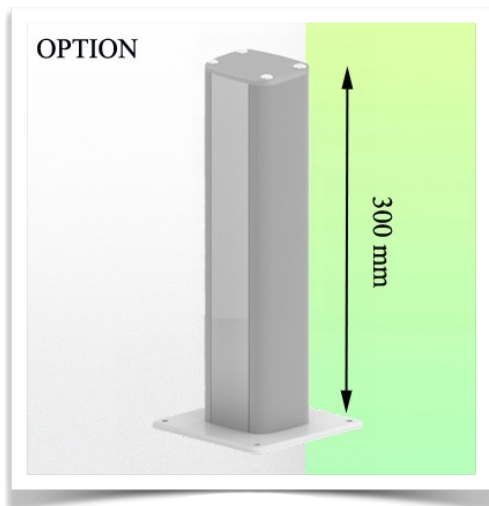

**Presentation**

**Part Number: WM 250.142MD**

**Medical arm with 5" plunge plate of Quick Release for height-adjustable monitoring, table column mount. Supported weight balance scale from 7,5 to 13 kg. Compatible with Mindray monitoring.**

**Mounting adapter (quick release)**

The monitor adaption is prepared to accept the mounting adapter from Mindray and is suitable for the following Mindray monitors: BeneVision series: N12, iMEC, uMEC, iPM, ePM and BeneView series: T5, T8, T9.



**Mounting adapter 5" Plunge plate**

The 5" plunge plate is suitable for the following Mindray monitors:  
BeneVision series: N12, iMEC, uMEC, iPM, ePM, BeneView series: T5, T8, T9 and VS series VS-600, VS-900, VS 8, VS 9.

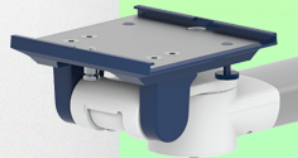

**Adaptation with 5" plunger plate**

**Monitor mounting plates for monitoring**

The 5" plunger plate is designed to accommodate bottom-mounted monitors. Please note that a special mounting adapter is required for some monitors. The mounting adapter is installed on the bottom and slides into the 5" immersion plate.

