

Presentation

Part Number: WM 250.162

Medical arm with 5" plunge plate for height-adjustable monitoring, Variable Pole Mount from 23 to 40 mm. Supported weight balance scale from 7,5 to 13 kg. Compatible with Dräger and GE monitoring.

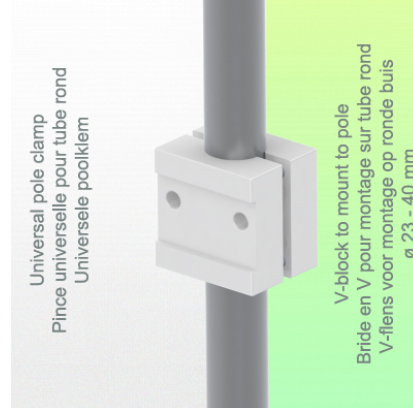
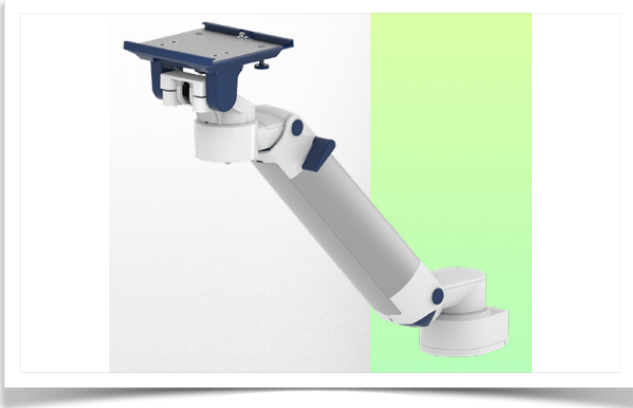

Medical arm with 5" plunge plate for height-adjustable monitoring, Variable Pole Mount from 23 to 40 mm. Supported weight balance scale from 7,5 to 13 kg. Compatible with Dräger and GE monitoring.

Full cable integration and infection prevention thanks to easy-to-clean surfaces make this arm ideal for emergency care areas. Height adjustment for ergonomic, customised positioning of the monitor. This 450 mm Horizontal Medical Arm with gas-lift height adjustment enables the monitor to be fixed, oriented and adjusted perfectly. It is coated with an anti-microbial agent for hygiene and cleaning down to the smallest detail. Its modern design has been specially developed for healthcare environments.

Technical specifications:

- * Integral cable entry * Equipotential bonding * This 450 mm Horizontal Arm with gas spring simply adjusts to the desired height and is fixed. It has a safety stop button for height adjustment, allowing the arm to remain in the chosen position.
- * The head of this arm has a 5" Plunge Plate and is compatible with Dräger and GE monitors. * Suitable for monitors weighing up to 7,5-13 Kg. * Monitor tilt: 21° down and 20° up * Monitor rotation: 115° right, 115° left. * Arm rotation: 105° right, 105° left * Height adjustment: 438 mm * Total length: 589 mm * All our medical arms comply with CE, ROHS, Medical Grade, Regulations MDD 93/42 ECC.
- * Colour: RAL 5013 cobalt blue and RAL 9016 traffic white * Warranty: 5 years

Technical specifications

Part Number: WM 250.162

Medical arm with 5" plunge plate for height-adjustable monitoring,
Variable Pole Mount from 23 to 40 mm. Supported weight balance scale from 7,5 to 13 kg.
Compatible with Dräger and GE monitoring.

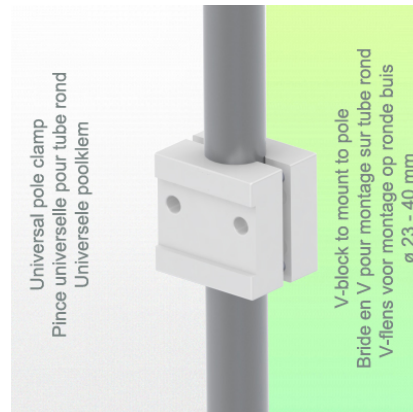

SIDE VIEW - VUE DE CÔTE - ZIJAAZICHT

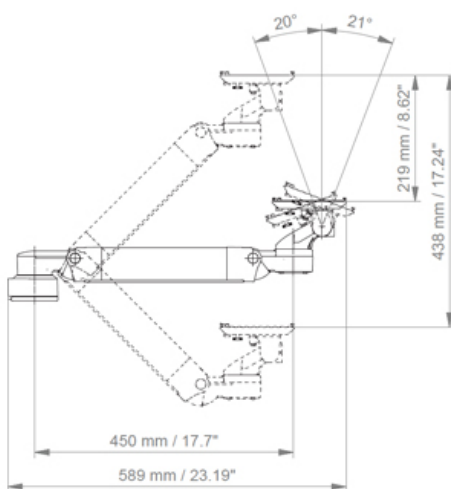

TOP VIEW
VUE DE DESSUS - BOVEN BEKIJKEN

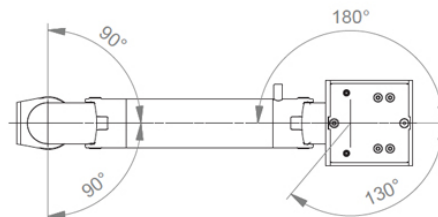

Monitor adaptation: 5" Plunge Plate

Height adjustment: Slow-release spring, parallel adapter for constant viewing angle

Colour: Decorative parts: RAL 5013 cobalt blue

Aluminium parts: RAL 9016 traffic white

Max. load capacity: 22 kg

Monitor adaptation max. load: 18 Kg

Balance scale on this medical arm: 7,5 - 13 Kg

Product weight: 3.8 Kg

Safety: Has a safety stop button for height adjustment, which allows the medical arm to remain in the chosen position.

Compatibility: Monitoring Dräger and GE

Presentation

Part Number: WM 250.162

Medical arm with 5" plunge plate for height-adjustable monitoring,
Variable Pole Mount from 23 to 40 mm. Supported weight balance scale from 7,5 to 13 kg.
Compatible with Dräger and GE monitoring.

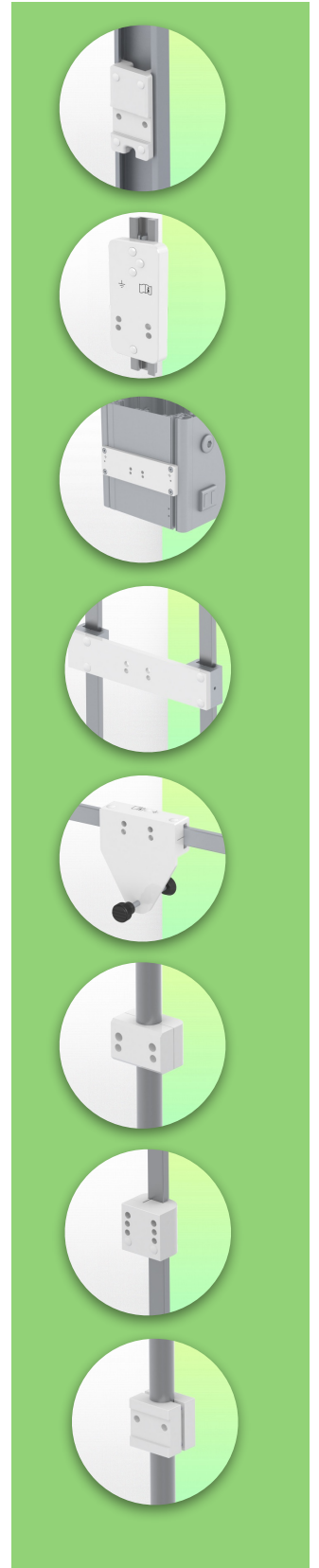
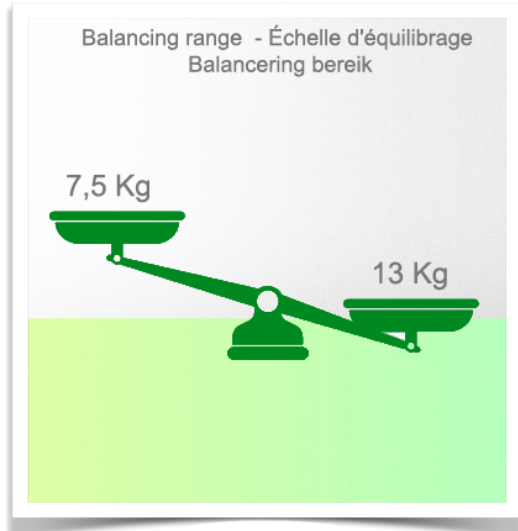

Installation information - Variable Pole Mount

Part Number: WM 250.162

**Medical arm with 5" plunge plate for height-adjustable monitoring,
Variable Pole Mount from 23 to 40 mm. Supported weight balance scale from 7,5 to 13 kg.
Compatible with Dräger and GE monitoring.**

Variable pole clamp:

Variable Pole mounting \varnothing 23 - 40 mm

* Please specify the diameter of the Pole when ordering.

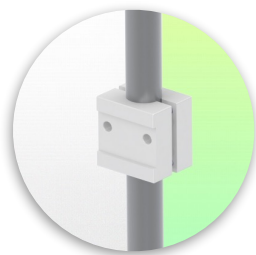
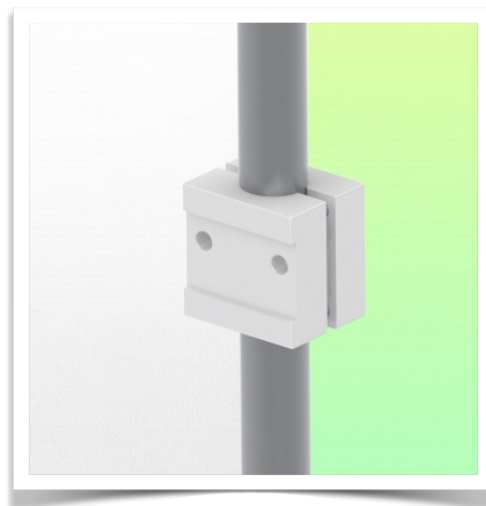
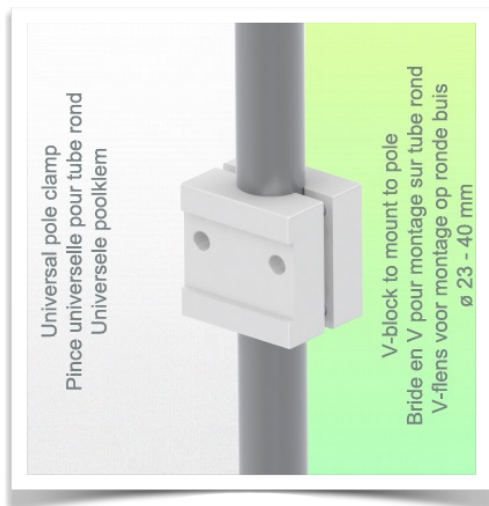

Presentation

Part Number: WM 250.162

**Medical arm with 5" plunge plate for height-adjustable monitoring,
Variable Pole Mount from 23 to 40 mm. Supported weight balance scale from 7,5 to 13 kg.
Compatible with Dräger and GE monitoring.**



Adaptation with 5" plunger plate

Monitor mounting plates for monitoring

The 5" plunger plate is designed to accommodate bottom-mounted monitors. Please note that a special mounting adapter is required for some monitors. The mounting adapter is installed on the bottom and slides into the 5" immersion plate. For Dräger and GE monitors, a special mounting adapter is not required. For Mindray, Nihon Kohden, Spacelabs and Philips Sure Signs/ Vital Signs monitors, mounting adapters are required. For the Philips IntelliVue series, please refer to the Philips Monitoring IntelliVue Series.

All our medical arms can be equipped with this adaptation, of which you will find some illustrations here.

All height-adjustable arms have a weight capacity of 22 kg. Rear-mounted monitor adapters and horizontally mounted 5" plinths accept a maximum monitor weight of 18 kg. An additional 4 kg can be mounted on a downstand under the front rotating part. Depending on the material and the strength factor, all weight indications have a safety factor of 4 and/or 6 times according to NF 60601-1 regulations. The current IEC 60601-1 standard for medical electrical equipment is the 3rd edition

For customised solutions and MRI applications please contact us

Presentation

Part Number: WM 250.162

Medical arm with 5" plunge plate for height-adjustable monitoring,
Variable Pole Mount from 23 to 40 mm. Supported weight balance scale from 7,5 to 13 kg.
Compatible with Dräger and GE monitoring.

