

Presentation

Part Number: WM 250.176NK

Double medical arm with 5" plunge plate and Nihon Kohden interface for height-adjustable monitoring, wall-mounted on vertical sliding rail.

Supported weight balance scale from 4 to 9 kg Nihon Kohden monitoring compatible

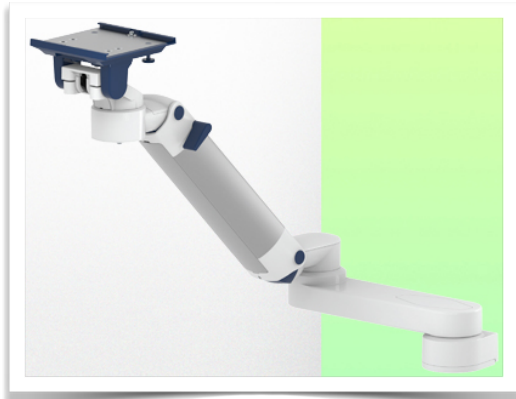

Double medical arm with 5" plunge plate and Nihon Kohden interface for height-adjustable monitoring, wall-mounted on vertical sliding rail.

Supported weight balance scale from 4 to 9 kg

Nihon Kohden monitoring compatible

Full cable integration and infection prevention thanks to easy-to-clean surfaces make this arm ideal for emergency care areas. Height adjustment for ergonomic, customised positioning of the monitor. This Horizontal Double Medical Arm with gas-lift height adjustment enables the monitor to be fixed, oriented and adjusted perfectly. It is coated with an anti-microbial agent for hygiene and cleaning down to the smallest detail. Its modern design has been specially developed for healthcare environments.

Technical specifications:

- * Integrated cable passage
- * Equipotential bonding
- * Fixing on optional Vertical Wall Slide Rail, of which several lengths are available (480 mm - 720 mm - 960 mm - 1200 mm). These wall rails can be easily cut to size. All cables also run through the wall rail. (See Options on the following pages)
- * This gas-operated Double Arm simply slides into the wall rail, then adjusts to the required height and locks into place. It has a safety stop button for height adjustment, which allows the arm to remain in the chosen position.
- * The head of this arm is fitted with a 5" plunge plate and Nihon Kohden Interface
- * Compatible with monitors weighing no more than 4-9 Kg
- * Monitor tilt: 21° down and 20° up
- * Screen rotation: 130° right, 180° left.
- * Arm rotation: 90° right, 90° left
- * Height adjustment: 438 mm
- * Total length 819 mm
- * All our medical arms comply with CE, ROHS, Medical Grade, Regulations MDD 93/42 ECC.
- * Colour: RAL 5013 cobalt blue and RAL 9016 traffic white
- * Warranty: 5 years

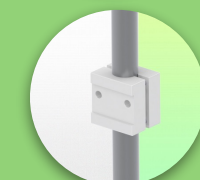

Technical specifications

Part Number: WM 250.176NK

Double medical arm with 5" plunge plate and Nihon Kohden interface for height-adjustable monitoring, wall-mounted on vertical sliding rail.

Supported weight balance scale from 4 to 9 kg Nihon Kohden monitoring compatible



Adaptateur pour glissière murale verticale
Adapter for vertical wall channel
Aapter voor verticaal wandkanaal



Pour montage sur glissière murale
To mount to wall channel
Om aan een muur te bevestigen railkanaal

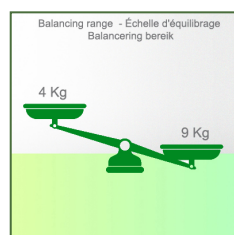
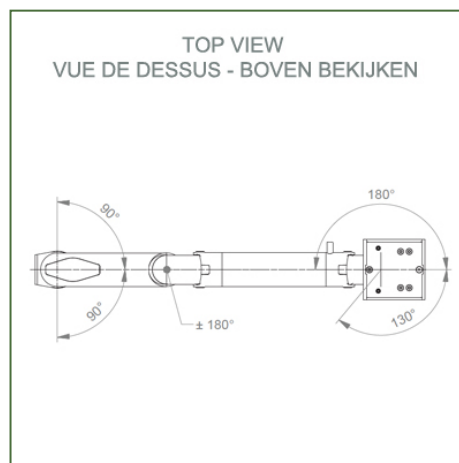
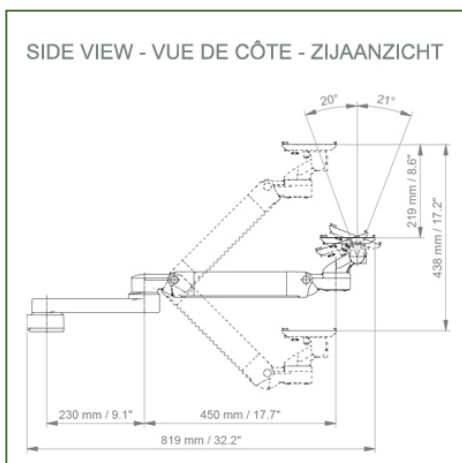

Monitor adaptation: 5" Plunge Plate

Colour: Decorative parts: RAL 5013 cobalt blue

Aluminium parts: RAL 9016 traffic white

Max. load capacity of support arm: 22 kg

Max. load monitor adaptation: 18 Kg

Balancing scale for this medical arm: 4 - 9 Kg

Product weight: 4,9 Kg

Height adjustment: parallel mechanism for a constant viewing angle

Safety: Has a safety stop button for height adjustment, allowing the medical arm to remain in the chosen position.

Installation information - Wall-mounted slide rail

Part Number: WM 250.176NK

Double medical arm with 5" plunge plate and Nihon Kohden interface for height-adjustable monitoring, wall-mounted on vertical sliding rail.

Supported weight balance scale from 4 to 9 kg Nihon Kohden monitoring compatible

Wall-mounted slide rail:

To install this medical arm, you must either use an existing rail in your installation or order one of our slide rails. These are available in standard lengths of 480mm, 720mm, 960mm and 1200mm. Custom lengths are available on request. Slide covers and end caps are supplied with every order.

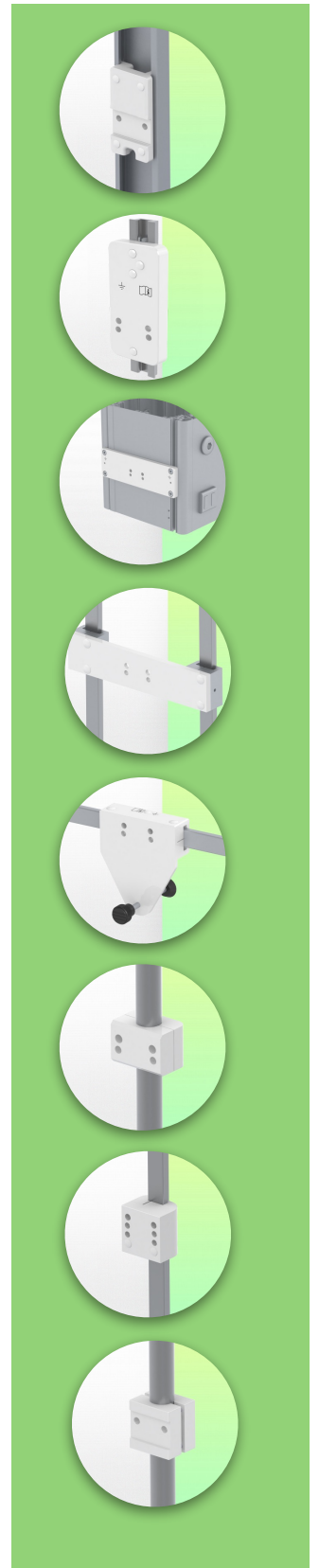
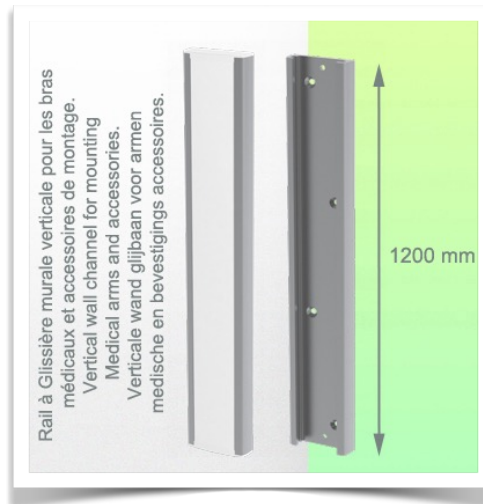
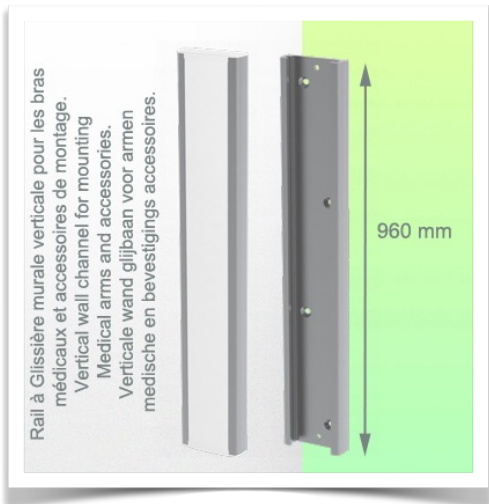
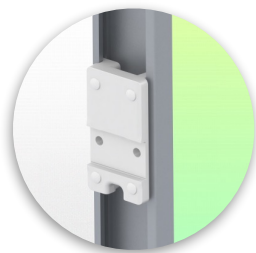
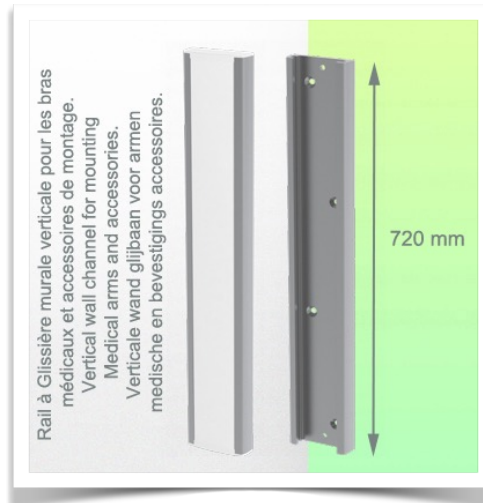
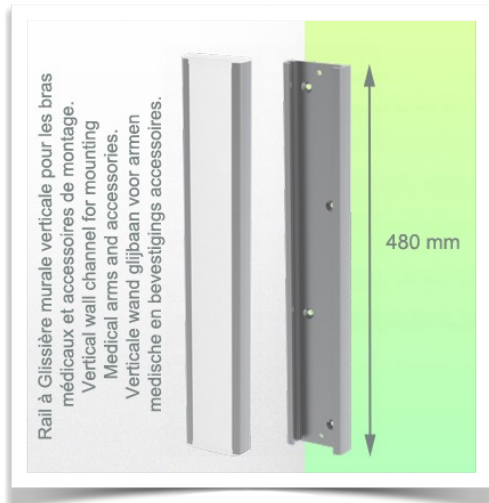

Presentation

Part Number: WM 250.176NK

**Double medical arm with 5" plunge plate and Nihon Kohden interface for height-adjustable monitoring, wall-mounted on vertical sliding rail.
Supported weight balance scale from 4 to 9 kg Nihon Kohden monitoring compatible**

**Adaptateur pour Nihon Kohden
Adapter for Nihon Kohden
Adapter voor Nihon Kohden**

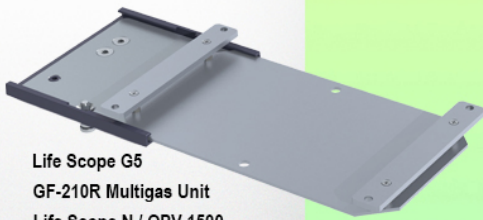

- Life Scope G5
- GF-210R Multigas Unit
- Life Scope N / OPV 1500
- Life Scope i / Life Scope L / BSM 2301 / BSM 2303
- Vismo PVM 2700 Vismo PVM 4000
- Life Scope VS / BSM 3500 / BSM 3700, Vismo PVM 2700
- Life Scope A / BSM 5105 / BSM 5135
- Life Scope TR / BSM 6301K / BSM 6501K / BSM 6701K



Adaptation with 5" plunger plate

Monitor mounting plates for monitoring

The 5" plunger plate is designed to accommodate bottom-mounted monitors. Please note that a special mounting adapter is required for some monitors. The mounting adapter is installed on the bottom and slides into the 5" immersion plate. For Dräger and GE monitors, a special mounting adapter is not required. For Mindray, Nihon Kohden, Spacelabs and Philips Sure Signs/ Vital Signs monitors, mounting adapters are required. For the Philips IntelliVue series, please refer to the Philips Monitoring IntelliVue Series.

All our medical arms can be equipped with this adaptation, of which you will find some illustrations here.

All height-adjustable arms have a weight capacity of 22 kg. Rear-mounted monitor adapters and horizontally mounted 5" plinths accept a maximum monitor weight of 18 kg. An additional 4 kg can be mounted on a downstand under the front rotating part. Depending on the material and the strength factor, all weight indications have a safety factor of 4 and/or 6 times according to NF 60601-1 regulations. The current IEC 60601-1 standard for medical electrical equipment is the 3rd edition

For customised solutions and MRI applications please contact us

Presentation

Part Number: WM 250.176NK

Double medical arm with 5" plunge plate and Nihon Kohden interface for height-adjustable monitoring, wall-mounted on vertical sliding rail.

Supported weight balance scale from 4 to 9 kg Nihon Kohden monitoring compatible

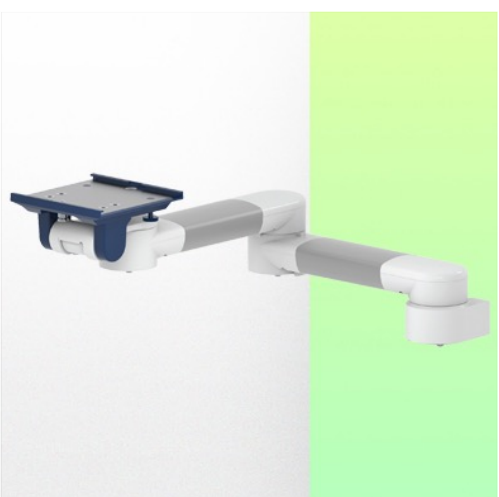

**Adaptateur pour Nihon Kohden
Adapter for Nihon Kohden
Adapter voor Nihon Kohden**

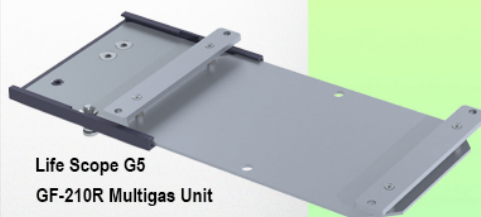

Life Scope G5
GF-210R Multigas Unit
Life Scope N / OPV 1500
Life Scope i / Life Scope L / BSM 2301 / BSM 2303
Vismo PVM 2700 Vismo PVM 4000
Life Scope VS / BSM 3500 / BSM 3700, Vismo PVM 2700
Life Scope A / BSM 5105 / BSM 5135
Life Scope TR / BSM 6301K / BSM 6501K / BSM 6701K

