

Presentation

Part Number: WM 250.185

Double medical arm with 5" plunge plate for height-adjustable monitoring, Table column mounting. Supported weight balance scale from 2 to 5 kg. Compatible with Dräger and GE monitoring.

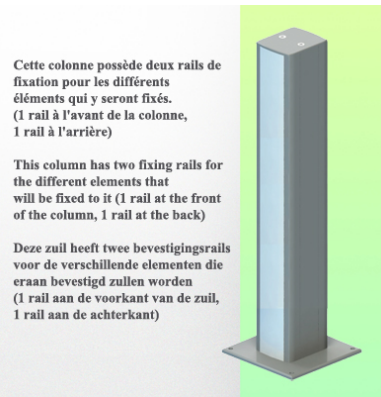

Double medical arm with 5" plunge plate for height-adjustable monitoring, Table column mounting Supported weight balance scale from 2 to 5 kg. Compatible with Dräger and GE monitoring.

Full cable integration and infection prevention thanks to easy-to-clean surfaces make this arm ideal for emergency care areas. Height adjustment for ergonomic, customised positioning of the monitor. This Horizontal Double Medical Arm with gas-lift height adjustment enables the monitor to be fixed, oriented and adjusted perfectly. It is coated with an anti-microbial agent for hygiene and cleaning down to the smallest detail. Its modern design has been specially developed for healthcare environments.

Technical specifications:

* Integrated cable passage * Equipotential bonding * Optional Table Columns are available in various heights (500 - 300 mm). These columns can be easily cut to size. All cables are also routed through the column. (See Option on the following pages) * This gas-operated Double Arm simply slides into the column rail, then adjusts to the required height and locks into place. It has a safety stop button for height adjustment, which allows the arm to remain in the chosen position. * The head of this arm is fitted with a 5" plunge plate * Compatible with monitors weighing no more than 2-5 Kg * Monitor tilt: 21° down and 20° up * Screen rotation: 130° right, 180° left. * Arm rotation: 90° right, 90° left * Height adjustment: 438 mm * Total length 819 mm * All our medical arms comply with CE, ROHS, Medical Grade, Regulations MDD 93/42 ECC. * Colour: RAL 5013 cobalt blue and RAL 9016 traffic white * Warranty: 5 years



Technical specifications

Part Number: WM 250.185

**Double medical arm with 5" plunge plate for height-adjustable monitoring,
Table column mounting. Supported weight balance scale from 2 to 5 kg.
Compatible with Dräger and GE monitoring.**



Cette colonne possède deux rails de fixation pour les différents éléments qui y seront fixés.
(1 rail à l'avant de la colonne, 1 rail à l'arrière)

This column has two fixing rails for the different elements that will be fixed to it (1 rail at the front of the column, 1 rail at the back)

Deze zuil heeft twee bevestigingsrails voor de verschillende elementen die eraan bevestigd zullen worden
(1 rail aan de voorkant van de zuil, 1 rail aan de achterkant)

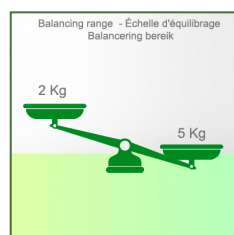
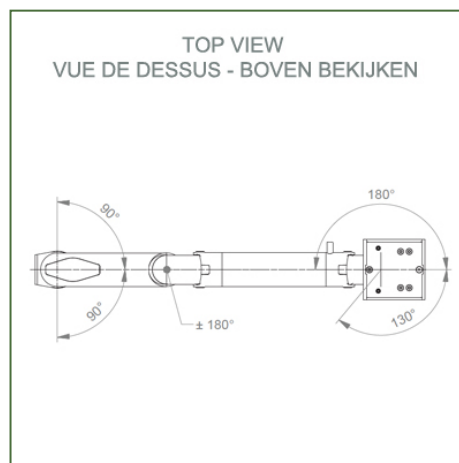
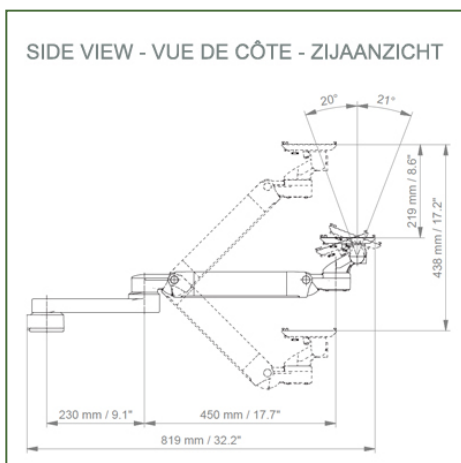

Monitor adaptation: 5" Plunge Plate
Colour: Decorative parts: RAL 5013 cobalt blue
Aluminium parts: RAL 9016 traffic white
Max. load capacity of support arm: 22 kg
Max. load monitor adaptation: 18 Kg
Balancing scale for this medical arm: 2 - 5 Kg
Product weight: 4,9 Kg

Height adjustment: parallel mechanism for a constant viewing angle

Safety: Has a safety stop button for height adjustment, allowing the medical arm to remain in the chosen position.

Installation information - Column Slide Rail

Part Number: WM 250.185

**Double medical arm with 5" plunge plate for height-adjustable monitoring,
Table column mounting. Supported weight balance scale from 2 to 5 kg.
Compatible with Dräger and GE monitoring.**

Table column:

To install this medical arm, you need to use one of our medical columns. These are available in standard heights of 500 and 300 mm. Custom heights are available on request. Slide covers and end caps are supplied with every order.

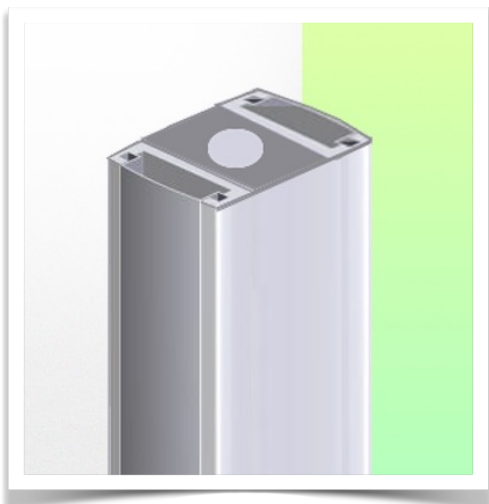
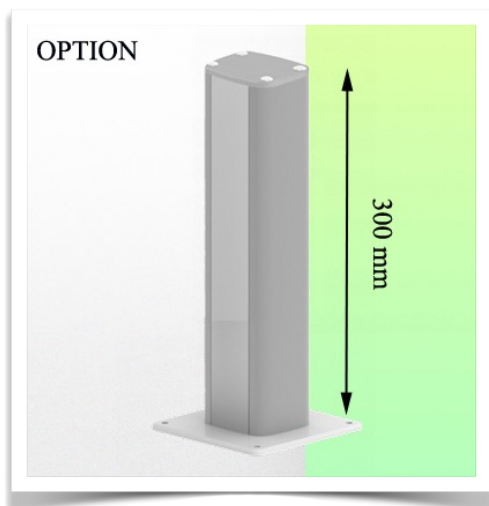

Presentation

Part Number: WM 250.185

**Double medical arm with 5" plunger plate for height-adjustable monitoring,
Table column mounting. Supported weight balance scale from 2 to 5 kg.
Compatible with Dräger and GE monitoring.**



Adaptation with 5" plunger plate

Monitor mounting plates for monitoring

The 5" plunger plate is designed to accommodate bottom-mounted monitors. Please note that a special mounting adapter is required for some monitors. The mounting adapter is installed on the bottom and slides into the 5" immersion plate. For Dräger and GE monitors, a special mounting adapter is not required. For Mindray, Nihon Kohden, Spacelabs and Philips Sure Signs/ Vital Signs monitors, mounting adapters are required. For the Philips IntelliVue series, please refer to the Philips Monitoring IntelliVue Series.

All our medical arms can be equipped with this adaptation, of which you will find some illustrations here.

All height-adjustable arms have a weight capacity of 22 kg. Rear-mounted monitor adapters and horizontally mounted 5" plinths accept a maximum monitor weight of 18 kg. An additional 4 kg can be mounted on a downstand under the front rotating part. Depending on the material and the strength factor, all weight indications have a safety factor of 4 and/or 6 times according to NF 60601-1 regulations. The current IEC 60601-1 standard for medical electrical equipment is the 3rd edition

For customised solutions and MRI applications please contact us

Presentation

Part Number: WM 250.185

Double medical arm with 5" plunge plate for height-adjustable monitoring,
Table column mounting. Supported weight balance scale from 2 to 5 kg.
Compatible with Dräger and GE monitoring.

