

Presentation

Part Number: WM 250.233MD

Double medical arm with 5" plunge plate or Quick Release for height-adjustable monitoring, Mounting on Amico medical device pendants and headwalls. Supported weight balance scale from 13 to 16 kg. Compatible with Mindray monitoring.

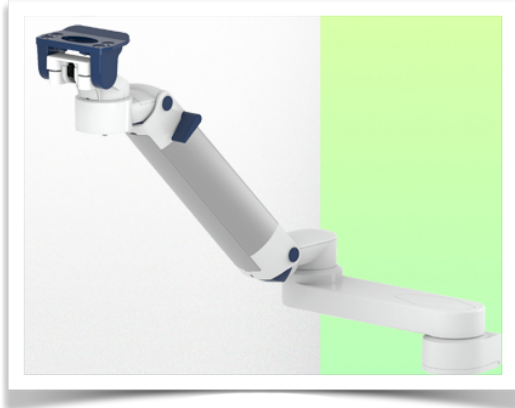

Double medical arm with 5" plunge plate or Quick Release for height-adjustable monitoring, Mounting on Amico medical device pendants and headwalls. Supported weight balance scale from 13 to 16 kg. Compatible with Mindray monitoring.

Full cable integration and infection prevention thanks to easy-to-clean surfaces make this arm ideal for emergency care areas. Height adjustment for ergonomic, customised positioning of the monitor. This Horizontal Double Medical Arm with gas-lift height adjustment enables the monitor to be fixed, oriented and adjusted perfectly. It is coated with an anti-microbial agent for hygiene and cleaning down to the smallest detail. Its modern design has been specially developed for healthcare environments.

Technical specifications:

* Integrated cable passage * Equipotential bonding * Fixing on the chosen adapter solution* This gas-operated Double Arm simply slides into the column rail, then adjusts to the required height and locks into place. It has a safety stop button for height adjustment, which allows the arm to remain in the chosen position. * The head of this arm is fitted with a 5" plunge plate or Quick Release * Compatible with monitors weighing no more than 13-16 Kg * Monitor tilt: 23° down and 18° up * Screen rotation: 130° right, 180° left. * Arm rotation: 90° right, 90° left * Height adjustment: 438 mm * Total length 799 mm * All our medical arms comply with CE, ROHS, Medical Grade, Regulations MDD 93/42 ECC. * Colour: RAL 5013 cobalt blue and RAL 9016 traffic white * Warranty: 5 years



Technical specifications

Part Number: WM 250.233MD

Double medical arm with 5" plunge plate or Quick Release for height-adjustable monitoring, Mounting on Amico medical device pendants and headwalls.

Supported weight balance scale from 13 to 16 kg. Compatible with Mindray monitoring.

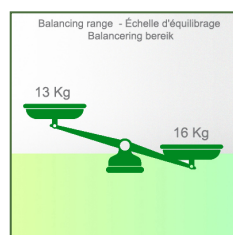
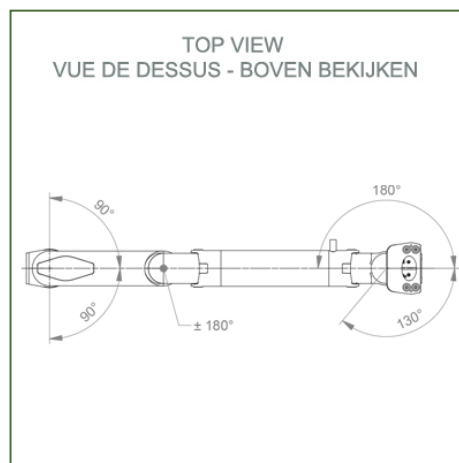
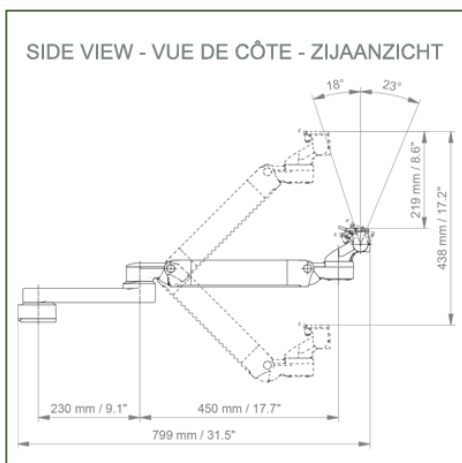
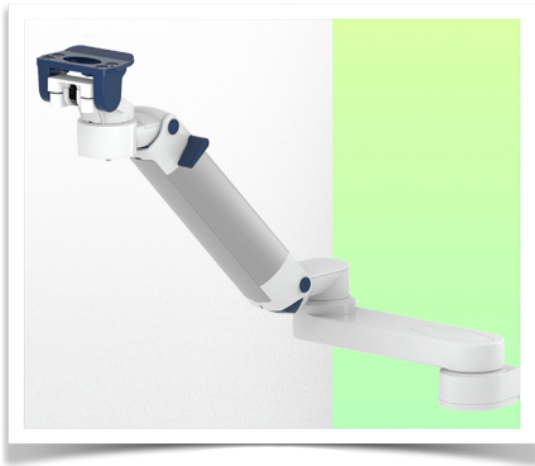

Monitor adaptation: 5" Plunge Plate or Quick Release

Colour: Decorative parts: RAL 5013 cobalt blue

Aluminium parts: RAL 9016 traffic white

Max. load capacity of support arm: 22 kg

Max. load monitor adaptation: 18 Kg

Balancing scale for this medical arm: 13 - 16 Kg

Product weight: 4,9 Kg

Height adjustment: parallel mechanism for a constant viewing angle

Safety: Has a safety stop button for height adjustment, allowing the medical arm to remain in the chosen position.

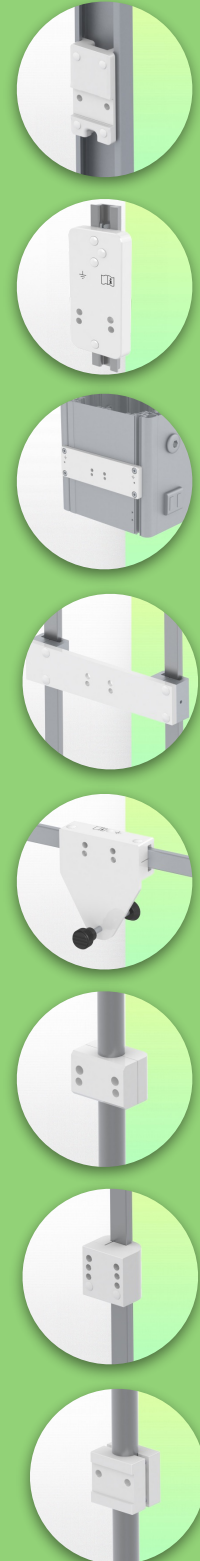

Installation information - Adapter Amico

Part Number: WM 250.233MD

Double medical arm with 5" plunge plate or Quick Release for height-adjustable monitoring, Mounting on Amico medical device pendants and headwalls.

Supported weight balance scale from 13 to 16 kg. Compatible with Mindray monitoring.

Adapter Amico:

Mounting on Amico medical device pendants and headwalls

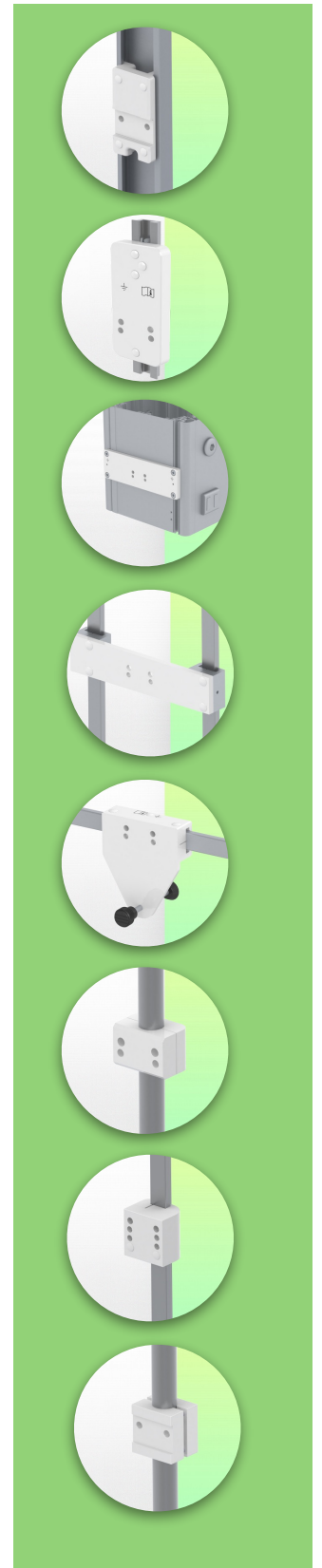

Presentation

Part Number: WM 250.233MD

Double medical arm with 5" plunge plate or Quick Release for height-adjustable monitoring, Mounting on Amico medical device pendants and headwalls. Supported weight balance scale from 13 to 16 kg. Compatible with Mindray monitoring.

Mounting adapter (quick release)

The monitor adaption is prepared to accept the mounting adapter from Mindray and is suitable for the following Mindray monitors: BeneVision series: N12, iMEC, uMEC, iPM, ePM and BeneView series: T5, T8, T9.



Mounting adapter 5" Plunge plate

The 5" plunge plate is suitable for the following Mindray monitors:
BeneVision series: N12, iMEC, uMEC, iPM, ePM, BeneView series: T5, T8, T9 and VS series VS-600, VS-900, VS 8, VS 9.

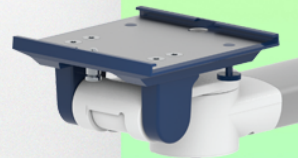

Adaptation with 5" plunger plate

Monitor mounting plates for monitoring

The 5" plunger plate is designed to accommodate bottom-mounted monitors. Please note that a special mounting adapter is required for some monitors. The mounting adapter is installed on the bottom and slides into the 5" immersion plate.

