

**Presentation**

**Part Number: WM 250.235MD**

**Double medical arm with 5" plunge plate or Quick Release for height-adjustable monitoring, Mounting on Anesthesia Machines (All manufacturers) Supported weight balance scale from 2 to 5 kg. Compatible with Mindray monitoring.**

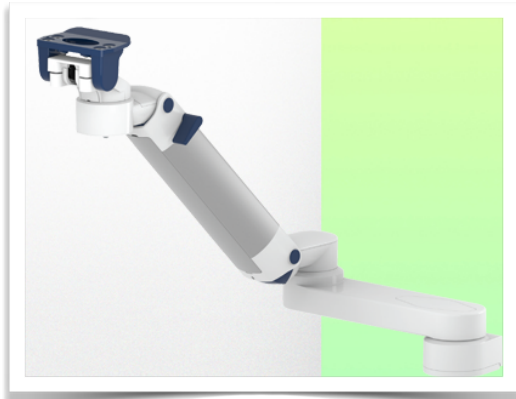

**Double medical arm with 5" plunge plate or Quick Release for height-adjustable monitoring, Mounting on Anesthesia Machines (All manufacturers) Supported weight balance scale from 2 to 5 kg. Compatible with Mindray monitoring.**

Full cable integration and infection prevention thanks to easy-to-clean surfaces make this arm ideal for emergency care areas. Height adjustment for ergonomic, customised positioning of the monitor. This Horizontal Double Medical Arm with gas-lift height adjustment enables the monitor to be fixed, oriented and adjusted perfectly. It is coated with an anti-microbial agent for hygiene and cleaning down to the smallest detail. Its modern design has been specially developed for healthcare environments.

**Technical specifications:**

- \* Integrated cable passage
- \* Equipotential bonding
- \* Fixing on the chosen adapter solution
- \* This gas-operated Double Arm simply slides into the column rail, then adjusts to the required height and locks into place. It has a safety stop button for height adjustment, which allows the arm to remain in the chosen position.
- \* The head of this arm is fitted with a 5" plunge plate or Quick Release
- \* Compatible with monitors weighing no more than 2-5 Kg
- \* Monitor tilt: 23° down and 18° up
- \* Screen rotation: 130° right, 180° left.
- \* Arm rotation: 90° right, 90° left
- \* Height adjustment: 438 mm
- \* Total length 799 mm
- \* All our medical arms comply with CE, ROHS, Medical Grade, Regulations MDD 93/42 ECC.
- \* Colour: RAL 5013 cobalt blue and RAL 9016 traffic white
- \* Warranty: 5 years



## Technical specifications

Part Number: WM 250.235MD

**Double medical arm with 5" plunge plate or Quick Release for height-adjustable monitoring, Mounting on Anesthesia Machines (All manufacturers)**

**Supported weight balance scale from 2 to 5 kg. Compatible with Mindray monitoring.**

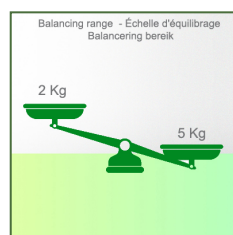
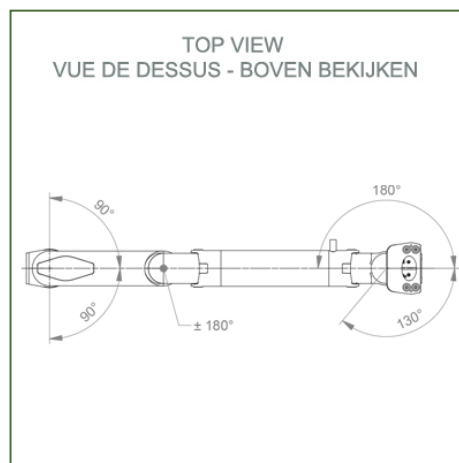
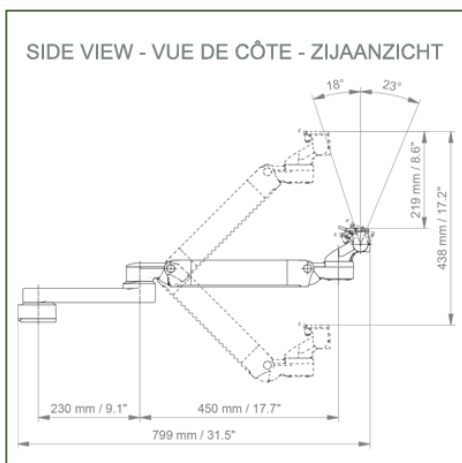
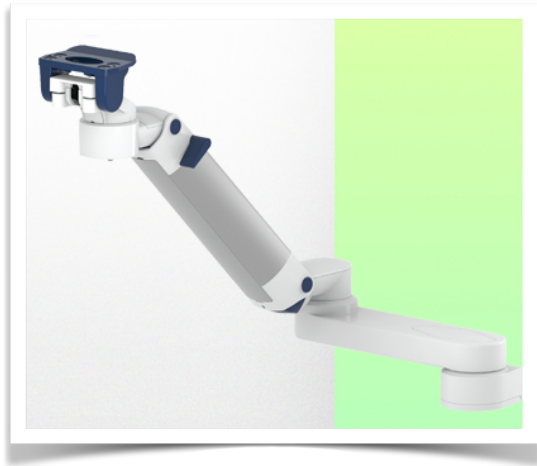

**Monitor adaptation:** 5" Plunge Plate or Quick Release

**Colour:** Decorative parts: RAL 5013 cobalt blue

**Aluminium parts:** RAL 9016 traffic white

**Max. load capacity of support arm:** 22 kg

**Max. load monitor adaptation:** 18 Kg

**Balancing scale for this medical arm:** 2 - 5 Kg

**Product weight:** 4,9 Kg

**Height adjustment:** parallel mechanism for a constant viewing angle

**Safety:** Has a safety stop button for height adjustment, allowing the medical arm to remain in the chosen position.

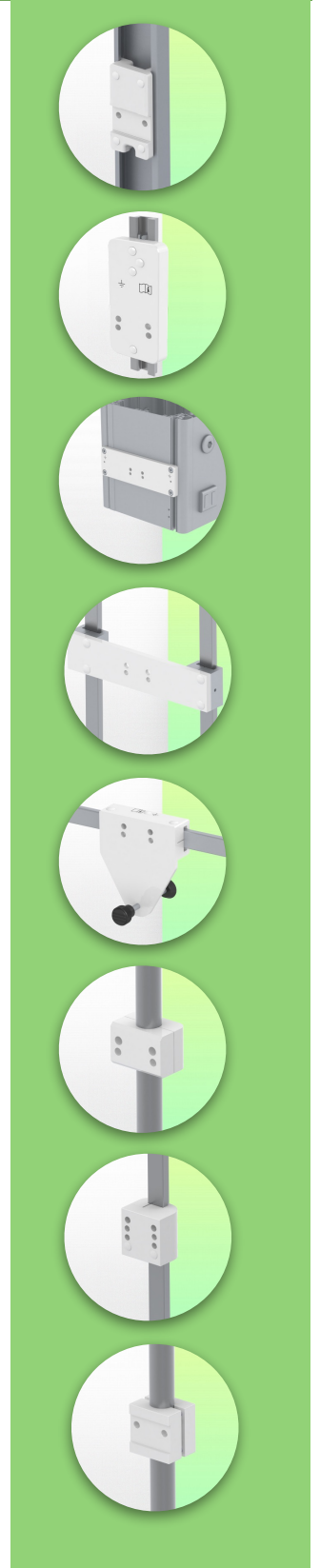

**Mounting Information - Adapter Anesthesia Machines**

**Part Number: WM 250.235MD**

**Double medical arm with 5" plunge plate or Quick Release for height-adjustable monitoring, Mounting on Anesthesia Machines (All manufacturers)  
Supported weight balance scale from 2 to 5 kg. Compatible with Mindray monitoring.**

**Adapter Anesthesia Machines:**

**Mounting on Anaesthesia Machines (All Manufacturers)**



Presentation

Part Number: WM 250.235MD

**Double medical arm with 5" plunge plate or Quick Release for height-adjustable monitoring, Mounting on Anesthesia Machines (All manufacturers) Supported weight balance scale from 2 to 5 kg. Compatible with Mindray monitoring.**

**Mounting adapter (quick release)**

The monitor adaption is prepared to accept the mounting adapter from Mindray and is suitable for the following Mindray monitors: BeneVision series: N12, iMEC, uMEC, iPM, ePM and BeneView series: T5, T8, T9.



**Mounting adapter 5" Plunge plate**

The 5" plunge plate is suitable for the following Mindray monitors:  
BeneVision series: N12, iMEC, uMEC, iPM, ePM, BeneView series: T5, T8, T9 and VS series VS-600, VS-900, VS 8, VS 9.

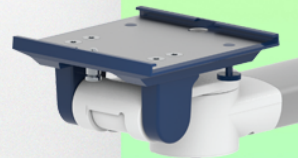

**Adaptation with 5" plunger plate**

**Monitor mounting plates for monitoring**

The 5" plunger plate is designed to accommodate bottom-mounted monitors. Please note that a special mounting adapter is required for some monitors. The mounting adapter is installed on the bottom and slides into the 5" immersion plate.

