

Presentation

Part Number: WM 250.272MD

Medical arm with 5" plunge plate or Quick Release for height-adjustable monitoring, Variable Pole Mount from 23 to 40 mm. Supported weight balance scale from 7,5 to 13 kg. Compatible with Mindray monitoring. Overhead mount

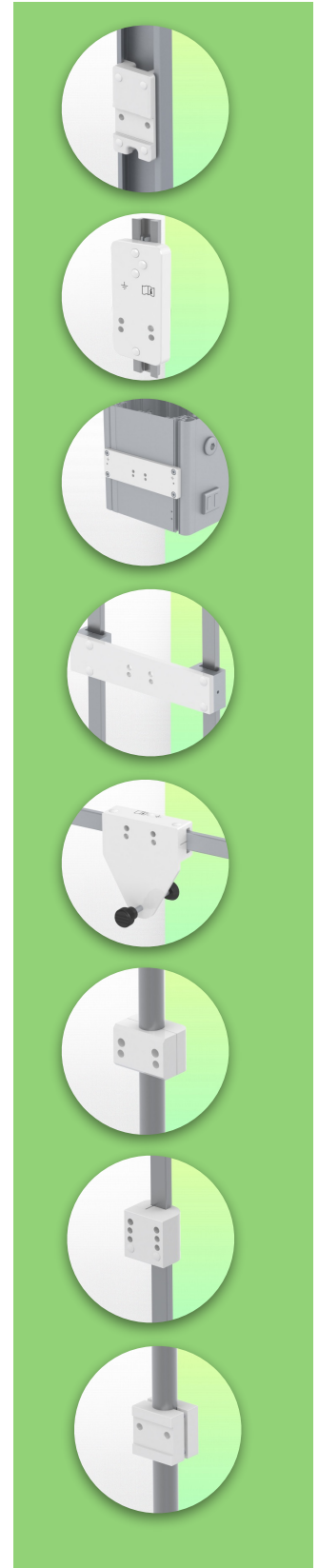
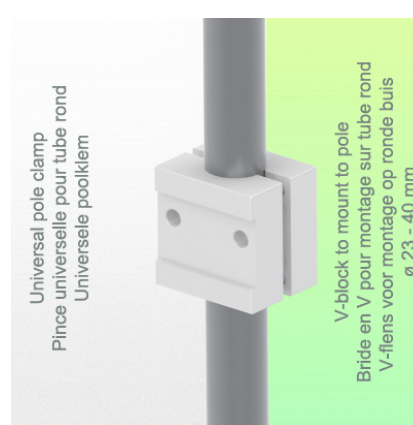
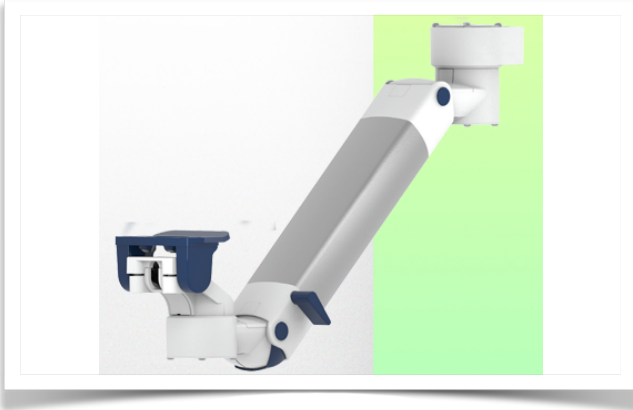

Medical arm with 5" plunge plate or Quick Release for height-adjustable monitoring, Variable Pole Mount from 23 to 40 mm. Supported weight balance scale from 7,5 to 13 kg. Compatible with Mindray monitoring. Overhead mount

Full cable integration and infection prevention thanks to easy-to-clean surfaces make this arm ideal for emergency care areas. Height adjustment for ergonomic, customised positioning of the monitor. This 450 mm Horizontal Medical Arm with gas-lift height adjustment enables the monitor to be fixed, oriented and adjusted perfectly. It is coated with an anti-microbial agent for hygiene and cleaning down to the smallest detail. Its modern design has been specially developed for healthcare environments.

Technical specifications:

- * Integral cable entry * Equipotential bonding * This 450 mm Horizontal Arm with gas spring simply adjusts to the desired height and is fixed. It has a safety stop button for height adjustment, allowing the arm to remain in the chosen position.
- * The head of this arm has a 5" Plunge Plateau Quick Release and is compatible with Mindray monitors. * Suitable for monitors weighing up to 7,5-13 Kg. * Monitor tilt: 23° down and 18° up * Monitor rotation: 130° right, 180° left. * Arm rotation: 90° right, 90° left * Height adjustment: 438 mm * Total length: 569 mm * All our medical arms comply with CE, ROHS, Medical Grade, Regulations MDD 93/42 ECC.
- * Colour: RAL 5013 cobalt blue and RAL 9016 traffic white * Warranty: 5 years

Technical specifications

Part Number: WM 250.272MD

Medical arm with 5" plunge plate or Quick Release for height-adjustable monitoring,
Variable Pole Mount from 23 to 40 mm. Supported weight balance scale from 7,5 to 13 kg.
Compatible with Mindray monitoring. Overhead mount

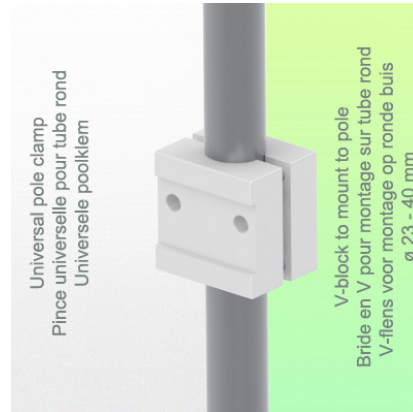

SIDE VIEW - VUE DE CÔTE - ZIJAAZICHT

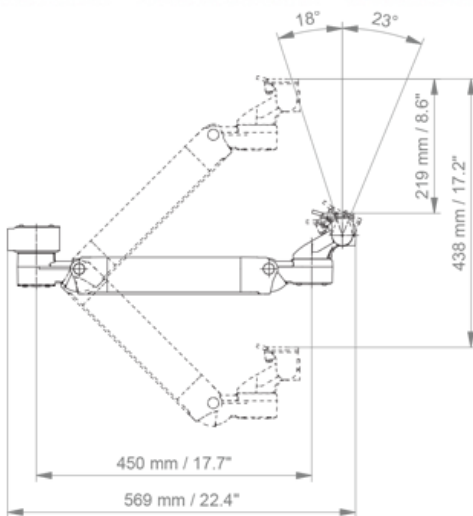

TOP VIEW
VUE DE DESSUS - BOVEN BEKIJKEN

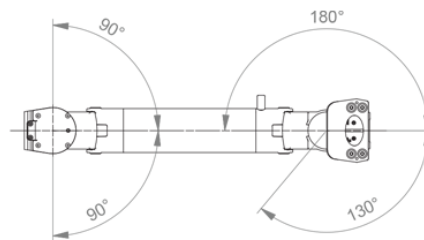

Monitor adaptation: 5" Plunge Plate or Quick Release

Height adjustment: Slow-release spring, parallel adapter for constant viewing angle

Colour: Decorative parts: RAL 5013 cobalt blue

Aluminium parts: RAL 9016 traffic white

Max. load capacity: 22 kg

Monitor adaptation max. load: 18 Kg

Balance scale on this medical arm: 7,5 - 13 Kg

Product weight: 3.8 Kg

Safety: Has a safety stop button for height adjustment, which allows the medical arm to remain in the chosen position.

Compatibility: Monitoring Mindray

Presentation

Part Number: WM 250.272MD

**Medical arm with 5" plunge plate or Quick Release for height-adjustable monitoring,
Variable Pole Mount from 23 to 40 mm. Supported weight balance scale from 7,5 to 13 kg.
Compatible with Mindray monitoring. Overhead mount**

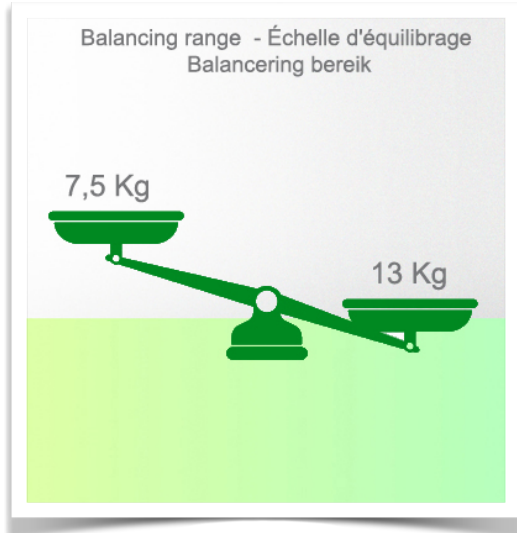

Installation information - Variable Pole Mount

Part Number: WM 250.272MD

Medical arm with 5" plunge plate or Quick Release for height-adjustable monitoring, Variable Pole Mount from 23 to 40 mm. Supported weight balance scale from 7,5 to 13 kg. Compatible with Mindray monitoring. Overhead mount

Variable pole clamp:

Variable Pole mounting \varnothing 23 - 40 mm

* Please specify the diameter of the Pole when ordering.

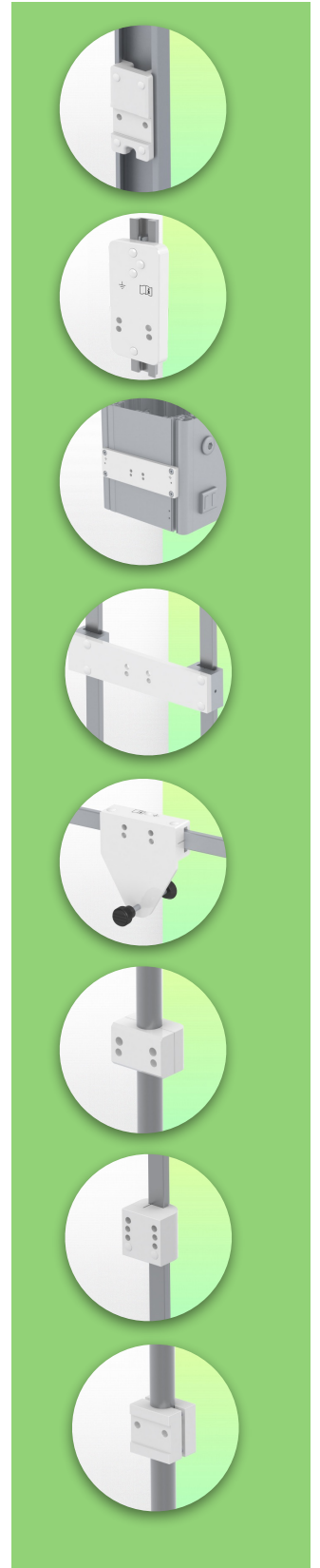
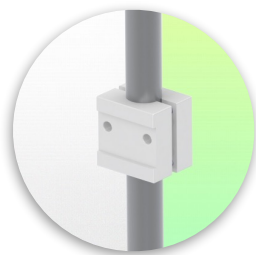
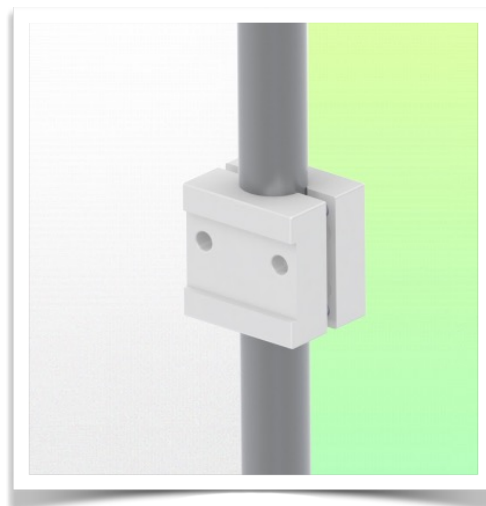

Presentation

Part Number: WM 250.272MD

Medical arm with 5" plunge plate or Quick Release for height-adjustable monitoring, Variable Pole Mount from 23 to 40 mm. Supported weight balance scale from 7,5 to 13 kg. Compatible with Mindray monitoring. Overhead mount

Mounting adapter (quick release)

The monitor adaption is prepared to accept the mounting adapter from Mindray and is suitable for the following Mindray monitors: BeneVision series: N12, iMEC, uMEC, iPM, ePM and BeneView series: T5, T8, T9.



Mounting adapter 5" Plunge plate

The 5" plunge plate is suitable for the following Mindray monitors:
BeneVision series: N12, iMEC, uMEC, iPM, ePM, BeneView series: T5, T8, T9 and VS series VS-600, VS-900, VS 8, VS 9.

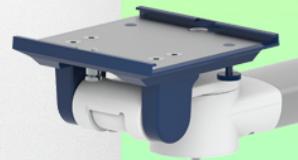

Adaptation with 5" plunger plate

Monitor mounting plates for monitoring

The 5" plunger plate is designed to accommodate bottom-mounted monitors. Please note that a special mounting adapter is required for some monitors. The mounting adapter is installed on the bottom and slides into the 5" immersion plate.

