

**Presentation**

**Part Number: WM 250.273MD**

**Medical arm with 5" plunge plate or Quick Release for height-adjustable monitoring, Variable Pole Mount from 23 to 40 mm. Supported weight balance scale from 13 to 16 kg. Compatible with Mindray monitoring. Overhead mount**

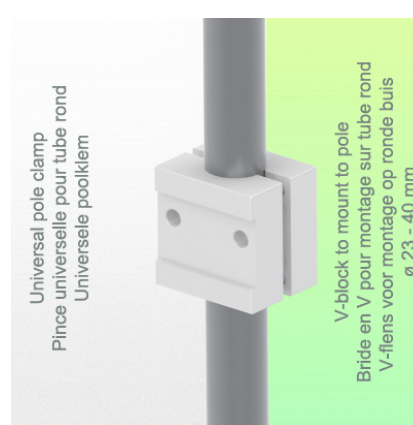
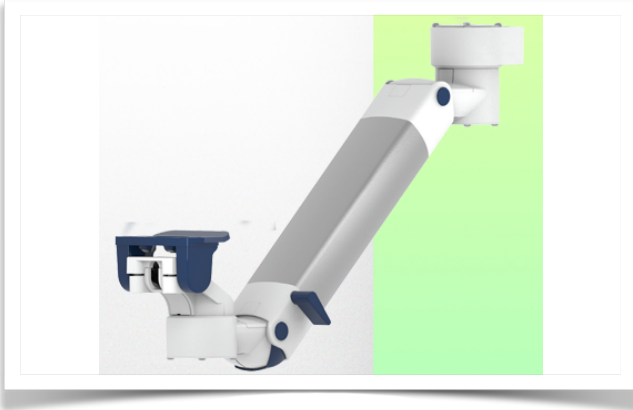

**Medical arm with 5" plunge plate or Quick Release for height-adjustable monitoring, Variable Pole Mount from 23 to 40 mm. Supported weight balance scale from 13 to 16 kg. Compatible with Mindray monitoring. Overhead mount**

Full cable integration and infection prevention thanks to easy-to-clean surfaces make this arm ideal for emergency care areas. Height adjustment for ergonomic, customised positioning of the monitor. This 450 mm Horizontal Medical Arm with gas-lift height adjustment enables the monitor to be fixed, oriented and adjusted perfectly. It is coated with an anti-microbial agent for hygiene and cleaning down to the smallest detail. Its modern design has been specially developed for healthcare environments.

**Technical specifications:**

- \* Integral cable entry \* Equipotential bonding \* This 450 mm Horizontal Arm with gas spring simply adjusts to the desired height and is fixed. It has a safety stop button for height adjustment, allowing the arm to remain in the chosen position.
- \* The head of this arm has a 5" Plunge Plateau Quick Release and is compatible with Mindray monitors. \* Suitable for monitors weighing up to 13-16 Kg. \* Monitor tilt: 23° down and 18° up \* Monitor rotation: 130° right, 180° left. \* Arm rotation: 90° right, 90° left \* Height adjustment: 438 mm \* Total length: 569 mm \* All our medical arms comply with CE, ROHS, Medical Grade, Regulations MDD 93/42 ECC.
- \* Colour: RAL 5013 cobalt blue and RAL 9016 traffic white \* Warranty: 5 years

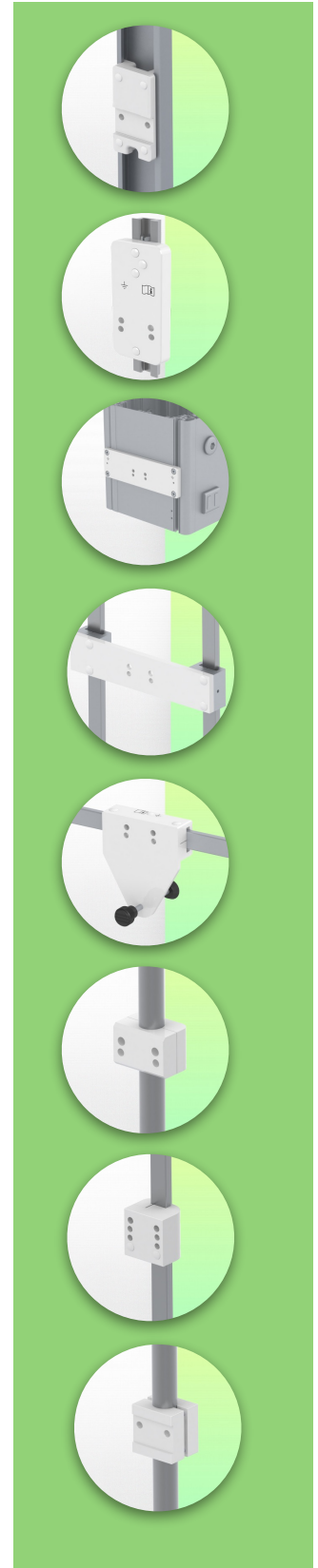

## Technical specifications

Part Number: WM 250.273MD

Medical arm with 5" plunge plate or Quick Release for height-adjustable monitoring,  
Variable Pole Mount from 23 to 40 mm. Supported weight balance scale from 13 to 16 kg.  
Compatible with Mindray monitoring. Overhead mount

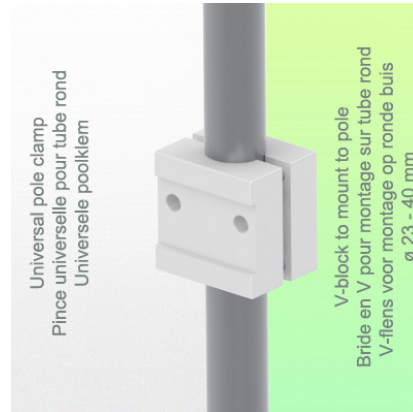

SIDE VIEW - VUE DE CÔTE - ZIJAAZICHT

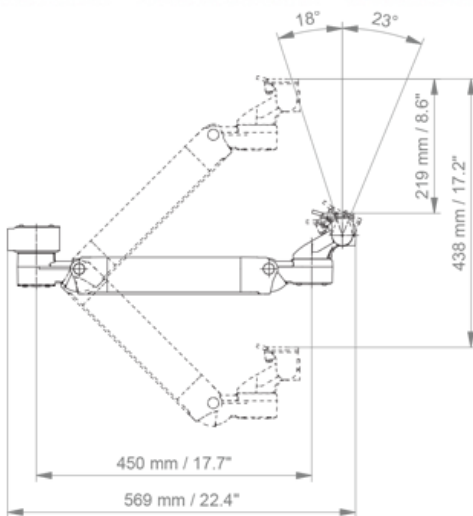

TOP VIEW  
VUE DE DESSUS - BOVEN BEKIJKEN

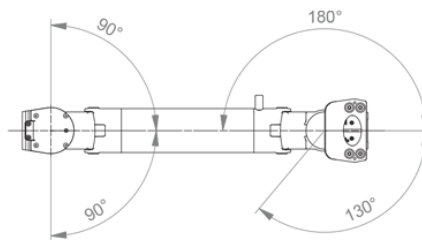

**Monitor adaptation:** 5" Plunge Plate or Quick Release

**Height adjustment:** Slow-release spring, parallel adapter for constant viewing angle

**Colour:** Decorative parts: RAL 5013 cobalt blue

**Aluminium parts:** RAL 9016 traffic white

**Max. load capacity:** 22 kg

**Monitor adaptation max. load:** 18 Kg

**Balance scale on this medical arm:** 13 - 16 Kg

**Product weight:** 3.8 Kg

**Safety:** Has a safety stop button for height adjustment, which allows the medical arm to remain in the chosen position.

**Compatibility:** Monitoring Mindray

**Presentation**

**Part Number: WM 250.273MD**

**Medical arm with 5" plunge plate or Quick Release for height-adjustable monitoring,  
Variable Pole Mount from 23 to 40 mm. Supported weight balance scale from 13 to 16 kg.  
Compatible with Mindray monitoring. Overhead mount**

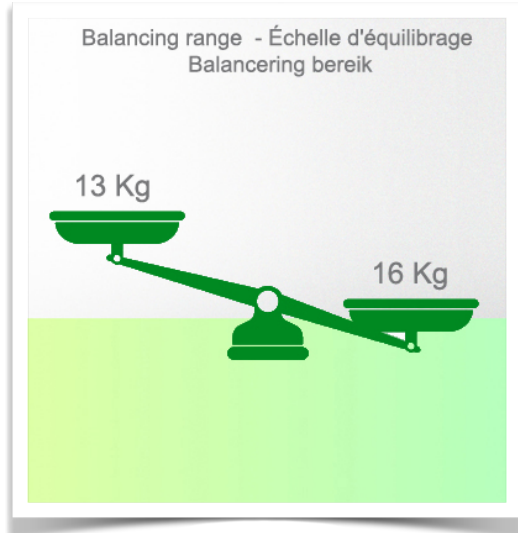

**Installation information - Variable Pole Mount**

**Part Number: WM 250.273MD**

**Medical arm with 5" plunge plate or Quick Release for height-adjustable monitoring, Variable Pole Mount from 23 to 40 mm. Supported weight balance scale from 13 to 16 kg. Compatible with Mindray monitoring. Overhead mount**

**Variable pole clamp:**

Variable Pole mounting  $\varnothing$  23 - 40 mm

\* Please specify the diameter of the Pole when ordering.

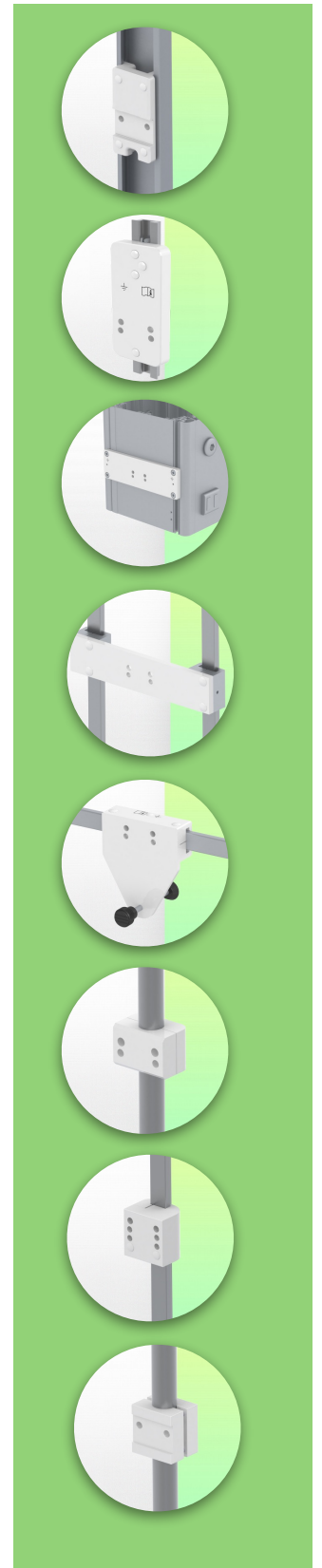
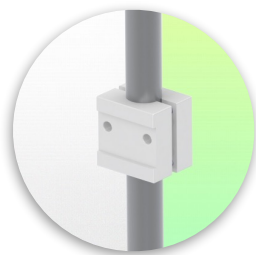
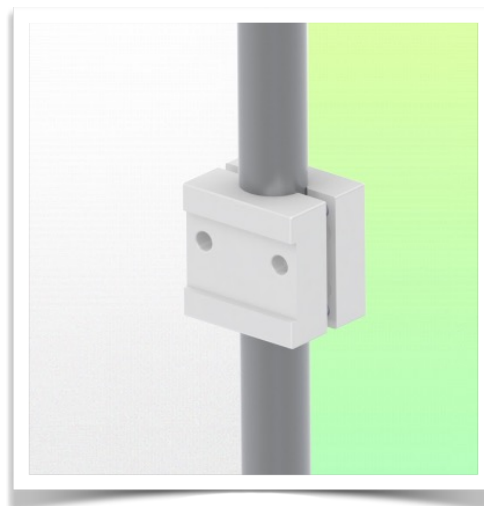

**Presentation**

**Part Number: WM 250.273MD**

**Medical arm with 5" plunge plate or Quick Release for height-adjustable monitoring, Variable Pole Mount from 23 to 40 mm. Supported weight balance scale from 13 to 16 kg. Compatible with Mindray monitoring. Overhead mount**

**Mounting adapter (quick release)**

The monitor adaption is prepared to accept the mounting adapter from Mindray and is suitable for the following Mindray monitors: BeneVision series: N12, iMEC, uMEC, iPM, ePM and BeneView series: T5, T8, T9.



**Mounting adapter 5" Plunge plate**

The 5" plunge plate is suitable for the following Mindray monitors:  
BeneVision series: N12, iMEC, uMEC, iPM, ePM, BeneView series: T5, T8, T9 and VS series VS-600, VS-900, VS 8, VS 9.

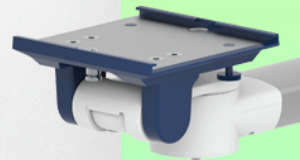

**Adaptation with 5" plunger plate**

**Monitor mounting plates for monitoring**

The 5" plunger plate is designed to accommodate bottom-mounted monitors. Please note that a special mounting adapter is required for some monitors. The mounting adapter is installed on the bottom and slides into the 5" immersion plate.

