

Presentation

Part Number: WM 250.325MD

Double medical arm with 5" plunge plate or Quick Release for height-adjustable monitoring, Mounting on Mindray Medical Power Supply Device. Overhead mount Supported weight balance scale from 2 to 5 kg. Compatible with Mindray monitoring.

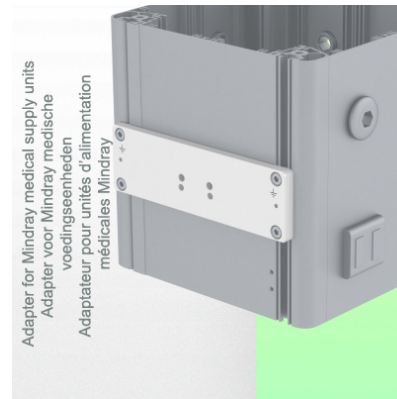
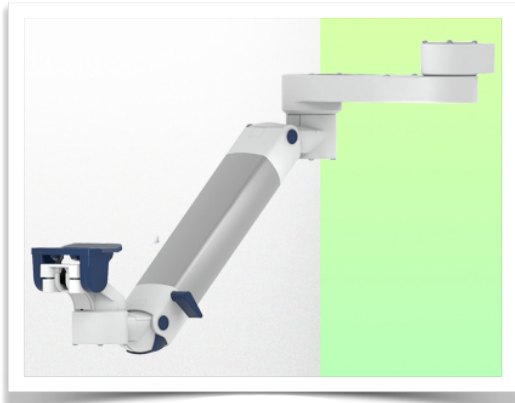

Double medical arm with 5" plunge plate or Quick Release for height-adjustable monitoring, Mounting on Mindray Medical Power Supply Device. Overhead mount . Supported weight balance scale from 2 to 5 kg. Compatible with Mindray monitoring.

Full cable integration and infection prevention thanks to easy-to-clean surfaces make this arm ideal for emergency care areas. Height adjustment for ergonomic, customised positioning of the monitor. This Horizontal Double Medical Arm with gas-lift height adjustment enables the monitor to be fixed, oriented and adjusted perfectly. It is coated with an anti-microbial agent for hygiene and cleaning down to the smallest detail. Its modern design has been specially developed for healthcare environments.

Technical specifications:

- * Integrated cable passage
- * Equipotential bonding
- * Fixing on the chosen adapter solution
- * This gas-operated Double Arm simply slides into the column rail, then adjusts to the required height and locks into place. It has a safety stop button for height adjustment, which allows the arm to remain in the chosen position.
- * The head of this arm is fitted with a 5" plunge plate or Quick Release
- * Compatible with monitors weighing no more than 2-5 Kg
- * Monitor tilt: 23° down and 18° up
- * Screen rotation: 130° right, 180° left.
- * Arm rotation: 90° right, 90° left
- * Height adjustment: 438 mm
- * Total length 799 mm
- * All our medical arms comply with CE, ROHS, Medical Grade, Regulations MDD 93/42 ECC.
- * Colour: RAL 5013 cobalt blue and RAL 9016 traffic white
- * Warranty: 5 years

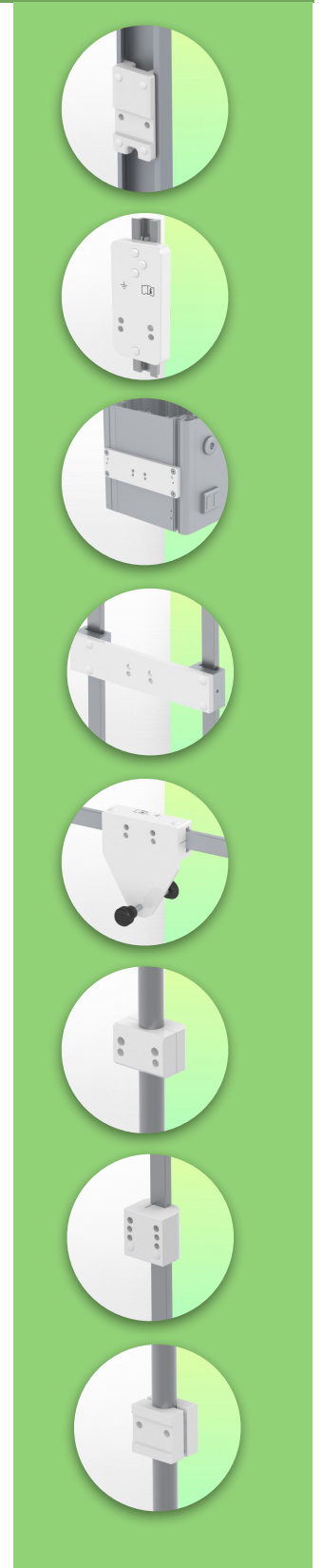

Technical specifications

Part Number: WM 250.325MD

**Double medical arm with 5" plunge plate or Quick Release for height-adjustable monitoring, Mounting on Mindray Medical Power Supply Device. Overhead mount
Supported weight balance scale from 2 to 5 kg. Compatible with Mindray monitoring.**

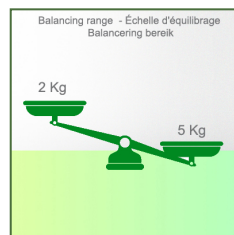
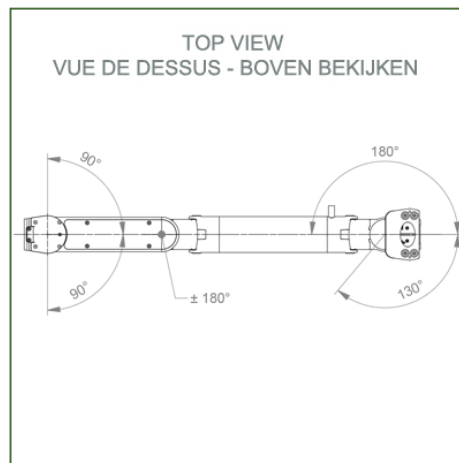
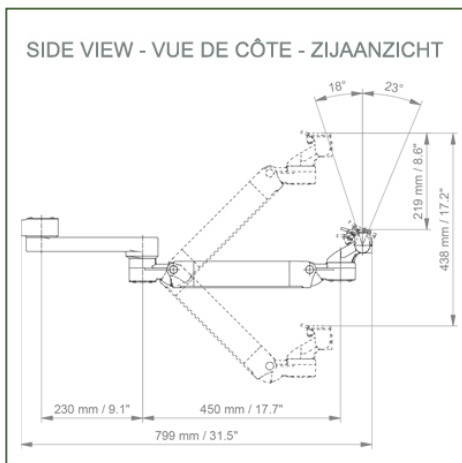
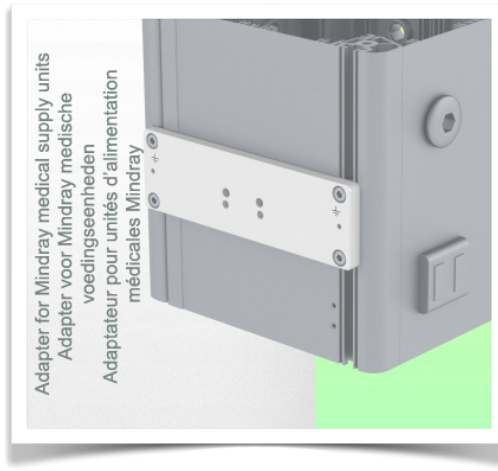
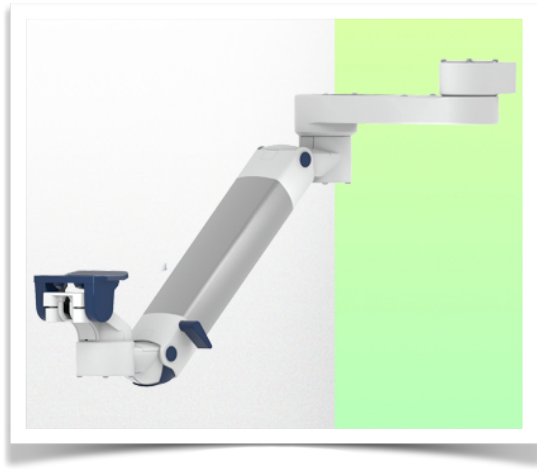

Monitor adaptation: 5" Plunge Plate or Quick Release for Mindray Monitoring

Colour: Decorative parts: RAL 5013 cobalt blue

Aluminium parts: RAL 9016 traffic white

Max. load capacity of support arm: 22 kg

Max. load monitor adaptation: 18 Kg

Balancing scale for this medical arm: 2 - 5 Kg

Product weight: 4,9 Kg

Height adjustment: parallel mechanism for a constant viewing angle

Safety: Has a safety stop button for height adjustment, allowing the medical arm to remain in the chosen position.

Installation information - Adapter Mindray

Part Number: WM 250.325MD

**Double medical arm with 5" plunge plate or Quick Release for height-adjustable monitoring, Mounting on Mindray Medical Power Supply Device. Overhead mount
Supported weight balance scale from 2 to 5 kg. Compatible with Mindray monitoring.**

Adapter Mindray:

Mounting on Mindray Medical Supply Device

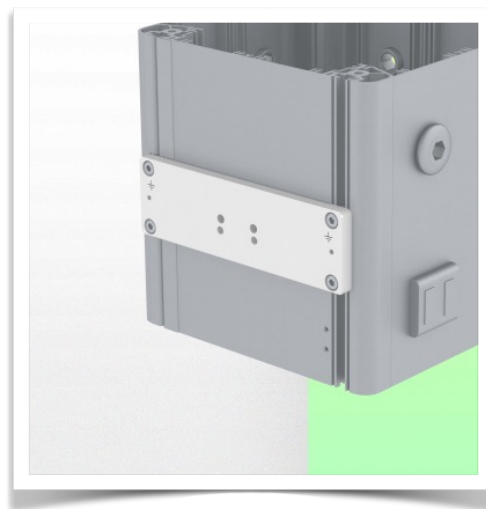
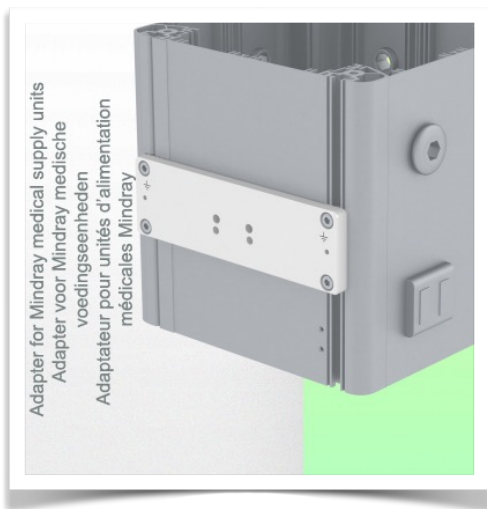

Presentation

Part Number: WM 250.325MD

Double medical arm with 5" plunge plate or Quick Release for height-adjustable monitoring, Mounting on Mindray Medical Power Supply Device. Overhead mount Supported weight balance scale from 2 to 5 kg. Compatible with Mindray monitoring.

Mounting adapter (quick release)

The monitor adaption is prepared to accept the mounting adapter from Mindray and is suitable for the following Mindray monitors: BeneVision series: N12, iMEC, uMEC, iPM, ePM and BeneView series: T5, T8, T9.



Mounting adapter 5" Plunge plate

The 5" plunge plate is suitable for the following Mindray monitors:
BeneVision series: N12, iMEC, uMEC, iPM, ePM, BeneView series: T5, T8, T9 and VS series VS-600, VS-900, VS 8, VS 9.

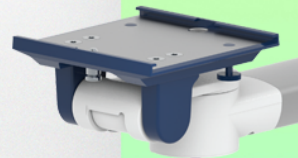

Adaptation with 5" plunger plate

Monitor mounting plates for monitoring

The 5" plunger plate is designed to accommodate bottom-mounted monitors. Please note that a special mounting adapter is required for some monitors. The mounting adapter is installed on the bottom and slides into the 5" immersion plate.



Presentation

Part Number: WM 250.325MD

Double medical arm with 5" plunge plate or Quick Release for height-adjustable monitoring, Mounting on Mindray Medical Power Supply Device. Overhead mount
Supported weight balance scale from 2 to 5 kg. Compatible with Mindray monitoring.

