

Presentation

Part Number: WM 250.440MD

Medical arm with 5" plunge plate or Quick Release for height-adjustable monitoring, Mounting on Anesthesia Machines (All Manufacturers). Supported weight balance scale from 2 to 5 kg. Compatible with Mindray monitoring.



Medical arm with 5" plunge plate or Quick Release for height-adjustable monitoring, Mounting on Anesthesia Machines (All Manufacturers). Supported weight balance scale from 2 to 5 kg. Compatible with Mindray monitoring.

Full cable integration and infection prevention thanks to easy-to-clean surfaces make this arm ideal for emergency care areas. Height adjustment for ergonomic, customised positioning of the monitor. This 569 mm Horizontal Medical Arm with gas-lift height adjustment enables the monitor to be fixed, oriented and adjusted perfectly. It is coated with an anti-microbial agent for hygiene and cleaning down to the smallest detail. Its modern design has been specially developed for healthcare environments.

Technical specifications:

- * Integral cable entry * Equipotential bonding * This 569 mm Horizontal Arm with gas spring simply adjusts to the desired height and is fixed. It has a safety stop button for height adjustment, allowing the arm to remain in the chosen position.
- * The head of this arm has a 5" Plunge Plate or Quick Release and is compatible with Mindray monitors. * Suitable for monitors weighing up to 2-5 Kg. * Monitor tilt: 23° down and 18° up * Monitor rotation: 130° right, 180° left. * Arm rotation: 90° right, 90° left * Height adjustment: 438 mm * Total length: 569 mm * All our medical arms comply with CE, ROHS, Medical Grade, Regulations MDD 93/42 ECC.
- * Colour: RAL 5013 cobalt blue and RAL 9016 traffic white * Warranty: 5 years



Technical specifications

Part Number: WM 250.440MD

Medical arm with 5" plunge plate or Quick Release for height-adjustable monitoring, Mounting on Anesthesia Machines (All Manufacturers). Supported weight balance scale from 2 to 5 kg. Compatible with Mindray monitoring.

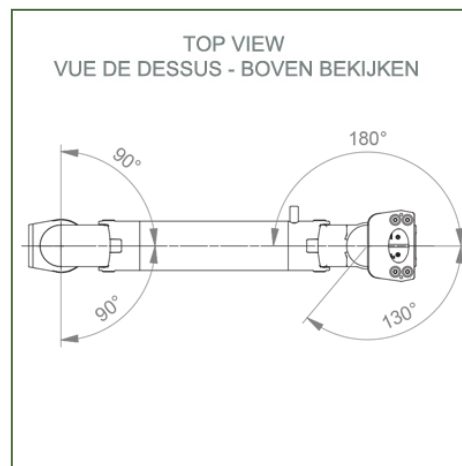
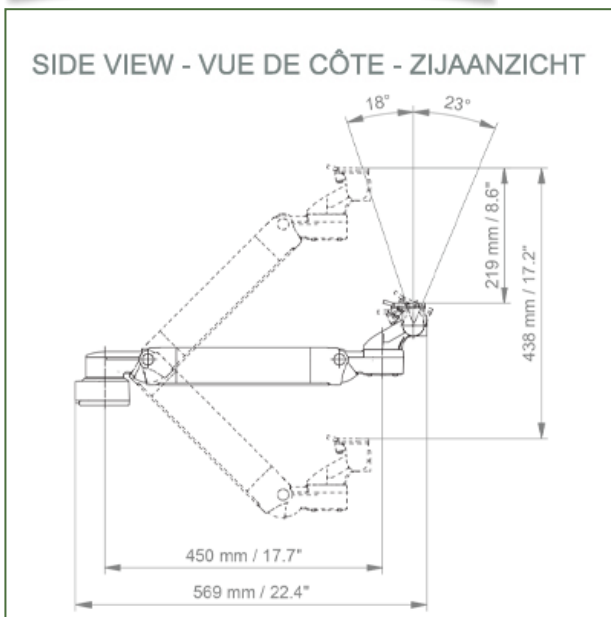
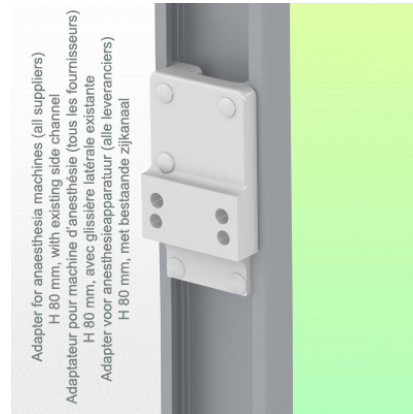

- Monitor adaptation:** 5" Plunge Plate or Quick Release
- Height adjustment:** Slow-release spring, parallel adapter for constant viewing angle
- Colour:** Decorative parts: RAL 5013 cobalt blue
- Aluminium parts:** RAL 9016 traffic white
- Max. load capacity:** 22 kg
- Monitor adaptation max. load:** 18 Kg
- Balance scale on this medical arm:** 2 - 5 Kg
- Product weight:** 3.8 Kg
- Safety:** Has a safety stop button for height adjustment, which allows the medical arm to remain in the chosen position.
- Compatibility:** Monitoring Mindray

Presentation

Part Number: WM 250.440MD

Medical arm with 5" plunge plate or Quick Release for height-adjustable monitoring,
Mounting on Anesthesia Machines (All Manufacturers).
Supported weight balance scale from 2 to 5 kg. Compatible with Mindray monitoring.

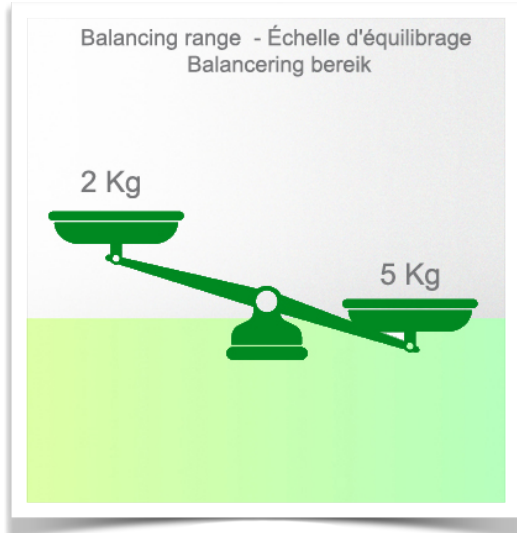

Installation information - Adapter Amico

Part Number: WM 250.440MD

**Medical arm with 5" plunge plate or Quick Release for height-adjustable monitoring,
Mounting on Anesthesia Machines (All Manufacturers).
Supported weight balance scale from 2 to 5 kg. Compatible with Mindray monitoring.**

Adapter Anesthesia Machines (All Manufacturers):

Mounting on Anesthesia Machines (All Manufacturers)

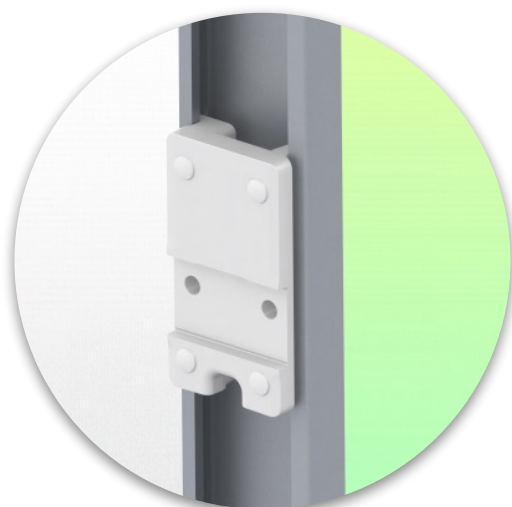

Presentation

Part Number: WM 250.440MD

Medical arm with 5" plunge plate or Quick Release for height-adjustable monitoring, Mounting on Anesthesia Machines (All Manufacturers). Supported weight balance scale from 2 to 5 kg. Compatible with Mindray monitoring.

Mounting adapter (quick release)

The monitor adaption is prepared to accept the mounting adapter from Mindray and is suitable for the following Mindray monitors: BeneVision series: N12, iMEC, uMEC, iPM, ePM and BeneView series: T5, T8, T9.



Mounting adapter 5" Plunge plate

The 5" plunge plate is suitable for the following Mindray monitors:
BeneVision series: N12, iMEC, uMEC, iPM, ePM, BeneView series: T5, T8, T9 and VS series VS-600, VS-900, VS 8, VS 9.

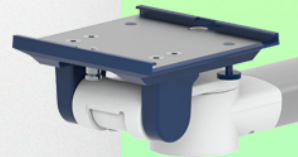

Adaptation with 5" plunger plate

Monitor mounting plates for monitoring

The 5" plunger plate is designed to accommodate bottom-mounted monitors. Please note that a special mounting adapter is required for some monitors. The mounting adapter is installed on the bottom and slides into the 5" immersion plate.

