

**Presentation**

**Part Number: WM 250.441NK**

**Medical arm with 5" plunge plate and Nihon Kohden interface for height-adjustable monitoring, for mounting on anaesthesia machines (all manufacturers). Supported weight balance scale from 4 Kg to 9 Kg. Nihon Kohden monitoring compatible**

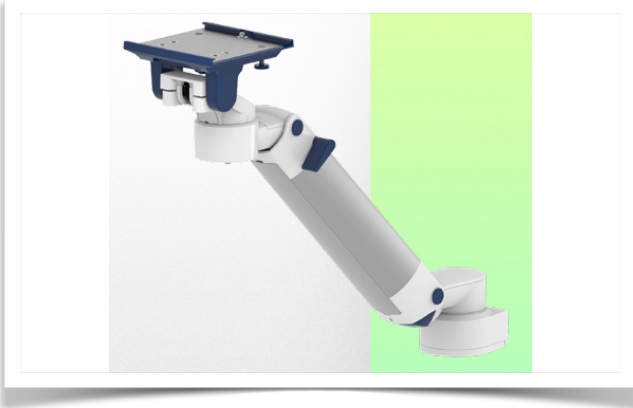

**Medical arm with 5" plunge plate and Nihon Kohden interface for height-adjustable monitoring, for mounting on anaesthesia machines (all manufacturers). Supported weight balance scale from 4 Kg to 9 Kg. Nihon Kohden monitoring compatible**

Full cable integration and infection prevention thanks to easy-to-clean surfaces make this arm ideal for emergency care areas. Height adjustment for ergonomic, customised positioning of the monitor. This 450 mm Horizontal Medical Arm with gas-lift height adjustment enables the monitor to be fixed, oriented and adjusted perfectly. It is coated with an anti-microbial agent for hygiene and cleaning down to the smallest detail. Its modern design has been specially developed for healthcare environments.

**Technical specifications:**

\* Integral cable entry \* Equipotential bonding \* This 450 mm Horizontal Arm with gas spring simply adjusts to the desired height and is fixed. It has a safety stop button for height adjustment, allowing the arm to remain in the chosen position. \* The head of this arm has a 5" Plunge Plate and is compatible with Nihon Kohden monitors. \* Suitable for monitors weighing up to 4-9 Kg. \* Monitor tilt: 21° down and 20° up \* Monitor rotation: 115° right, 115° left. \* Arm rotation: 105° right, 105° left \* Height adjustment: 438 mm \* Total length: 589 mm \* All our medical arms comply with CE, ROHS, Medical Grade, Regulations MDD 93/42 ECC. \* Colour: RAL 5013 cobalt blue and RAL 9016 traffic white \* Warranty: 5 years

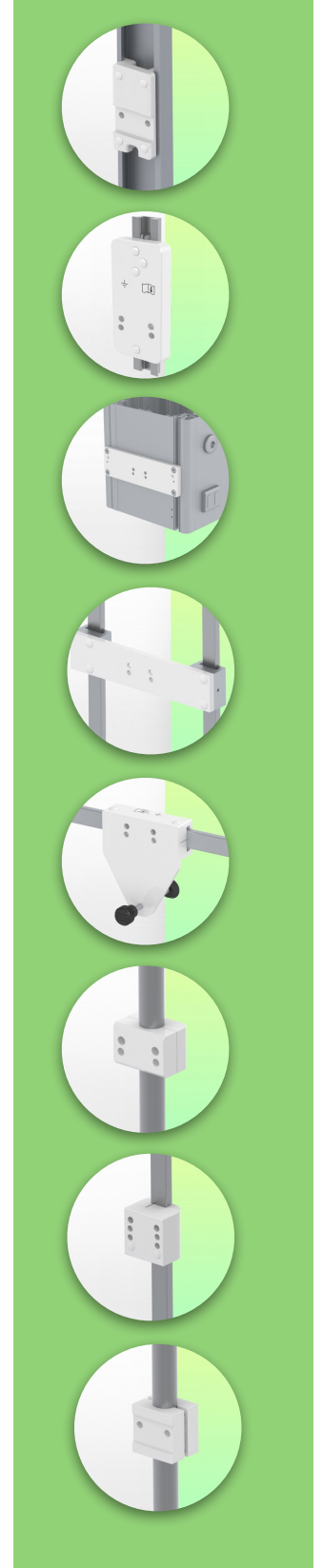

## Technical specifications

Part Number: WM 250.441NK

**Medical arm with 5" plunge plate and Nihon Kohden interface for height-adjustable monitoring, for mounting on anaesthesia machines (all manufacturers).**

**Supported weight balance scale from 4 Kg to 9 Kg. Nihon Kohden monitoring compatible**

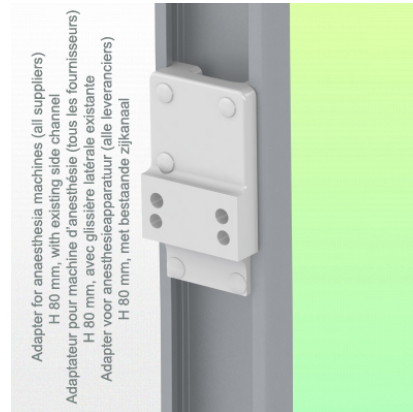

SIDE VIEW - VUE DE CÔTE - ZIJAAZICHT

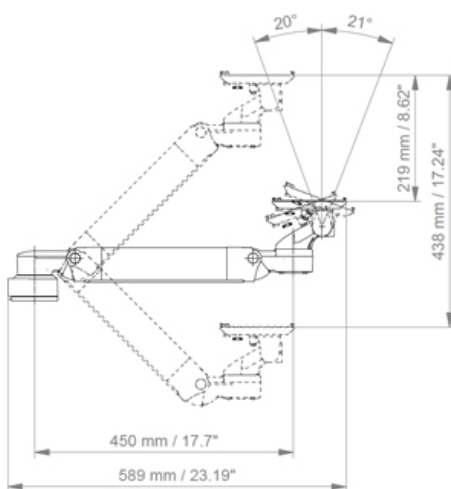

TOP VIEW  
VUE DE DESSUS - BOVEN BEKIJKEN

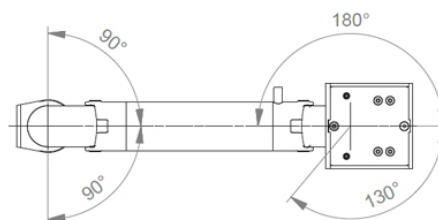

**Monitor adaptation:** 5" Plunge Plate

**Height adjustment:** Slow-release spring, parallel adapter for constant viewing angle

**Colour:** Decorative parts: RAL 5013 cobalt blue

**Aluminium parts:** RAL 9016 traffic white

**Max. load capacity:** 22 kg

**Monitor adaptation max. load:** 18 Kg

**Balance scale on this medical arm:** 2 - 5 Kg

**Product weight:** 3.8 Kg

**Safety:** Has a safety stop button for height adjustment, which allows the medical arm to remain in the chosen position.

**Compatibility:** Monitoring Dräger and GE

**Presentation**

**Part Number: WM 250.441NK**

**Medical arm with 5" plunge plate and Nihon Kohden interface for height-adjustable monitoring, for mounting on anaesthesia machines (all manufacturers).**

**Supported weight balance scale from 4 Kg to 9 Kg. Nihon Kohden monitoring compatible**

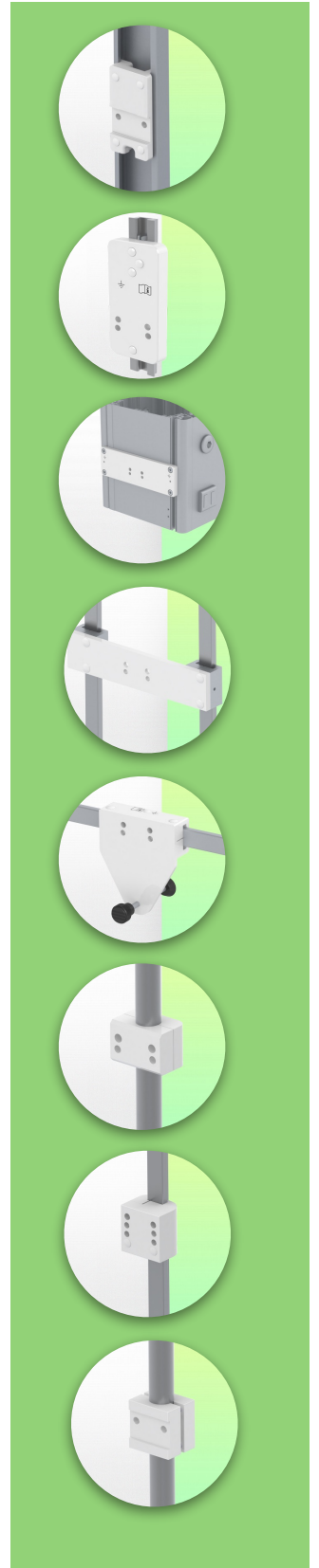
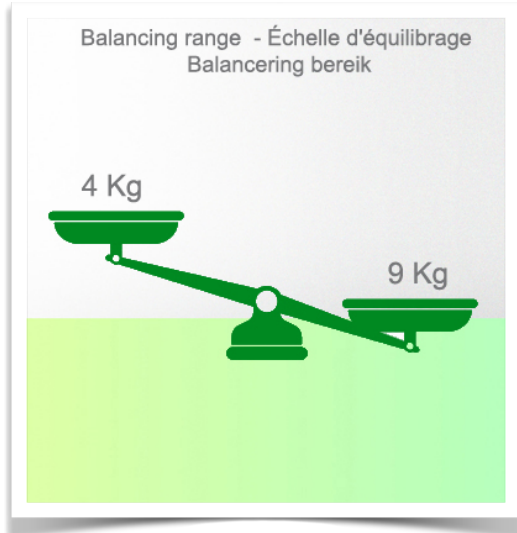

**Installation information - Adapter Amico**

**Part Number: WM 250.441NK**

**Medical arm with 5" plunge plate and Nihon Kohden interface for height-adjustable monitoring, for mounting on anaesthesia machines (all manufacturers).**

**Supported weight balance scale from 4 Kg to 9 Kg. Nihon Kohden monitoring compatible**

**Adapter Anesthesia Machines (All Manufacturers):**

**Mounting on Anesthesia Machines (All Manufacturers)**

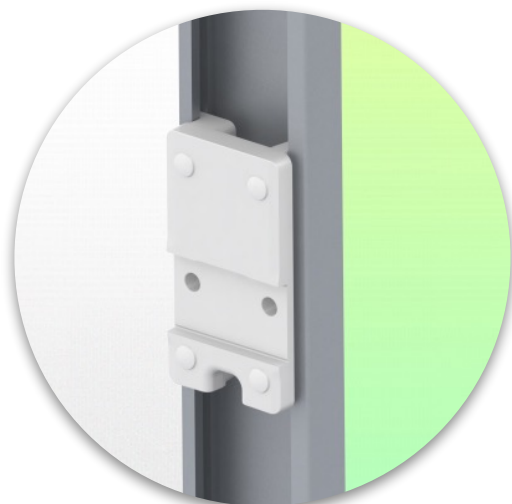



Presentation

Part Number: WM 250.441NK

**Medical arm with 5" plunge plate and Nihon Kohden interface for height-adjustable monitoring, for mounting on anaesthesia machines (all manufacturers).**

**Supported weight balance scale from 4 Kg to 9 Kg. Nihon Kohden monitoring compatible**

**Adaptateur pour Nihon Kohden  
Adapter for Nihon Kohden  
Adapter voor Nihon Kohden**

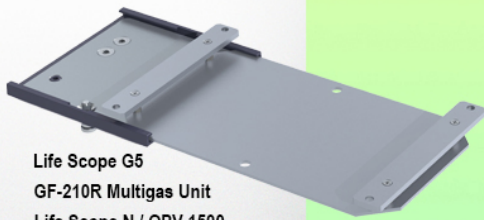

Life Scope G5  
GF-210R Multigas Unit  
Life Scope N / OPV 1500  
Life Scope i / Life Scope L / BSM 2301 / BSM 2303  
Vismo PVM 2700 Vismo PVM 4000  
Life Scope VS / BSM 3500 / BSM 3700, Vismo PVM 2700  
Life Scope A / BSM 5105 / BSM 5135  
Life Scope TR / BSM 6301K / BSM 6501K / BSM 6701K



**Adaptation with 5" plunger plate**

**Monitor mounting plates for monitoring**

The 5" plunger plate is designed to accommodate bottom-mounted monitors. Please note that a special mounting adapter is required for some monitors. The mounting adapter is installed on the bottom and slides into the 5" immersion plate. For Dräger and GE monitors, a special mounting adapter is not required. For Mindray, Nihon Kohden, Spacelabs and Philips Sure Signs/ Vital Signs monitors, mounting adapters are required. For the Philips IntelliVue series, please refer to the Philips Monitoring IntelliVue Series.

All our medical arms can be equipped with this adaptation, of which you will find some illustrations here.

All height-adjustable arms have a weight capacity of 22 kg. Rear-mounted monitor adapters and horizontally mounted 5" plinths accept a maximum monitor weight of 18 kg. An additional 4 kg can be mounted on a downstand under the front rotating part. Depending on the material and the strength factor, all weight indications have a safety factor of 4 and/or 6 times according to NF 60601-1 regulations. The current IEC 60601-1 standard for medical electrical equipment is the 3rd edition

For customised solutions and MRI applications please contact us

Presentation

Part Number: WM 250.441NK

Medical arm with 5" plunge plate and Nihon Kohden interface for height-adjustable monitoring, for mounting on anaesthesia machines (all manufacturers).

Supported weight balance scale from 4 Kg to 9 Kg. Nihon Kohden monitoring compatible

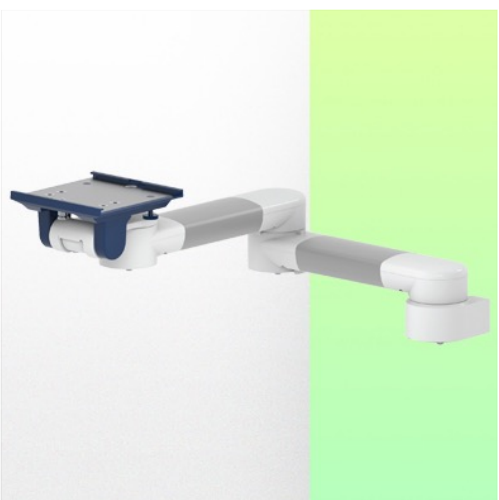

Adaptateur pour Nihon Kohden  
Adapter for Nihon Kohden  
Adapter voor Nihon Kohden

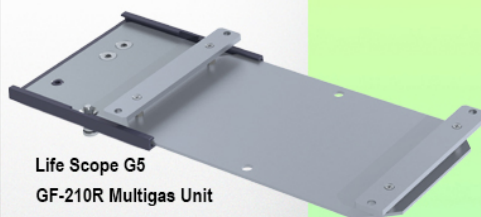

Life Scope G5  
GF-210R Multigas Unit  
Life Scope N / OPV 1500  
Life Scope i / Life Scope L / BSM 2301 / BSM 2303  
Vismo PVM 2700 Vismo PVM 4000  
Life Scope VS / BSM 3500 / BSM 3700, Vismo PVM 2700  
Life Scope A / BSM 5105 / BSM 5135  
Life Scope TR / BSM 6301K / BSM 6501K / BSM 6701K

