

**Presentation**

**Part Number: WM 260.112**

**363 mm Horizontal Medical Arm for monitoring Philips Intellivue Séries,  
Din rail mount Vertical.**

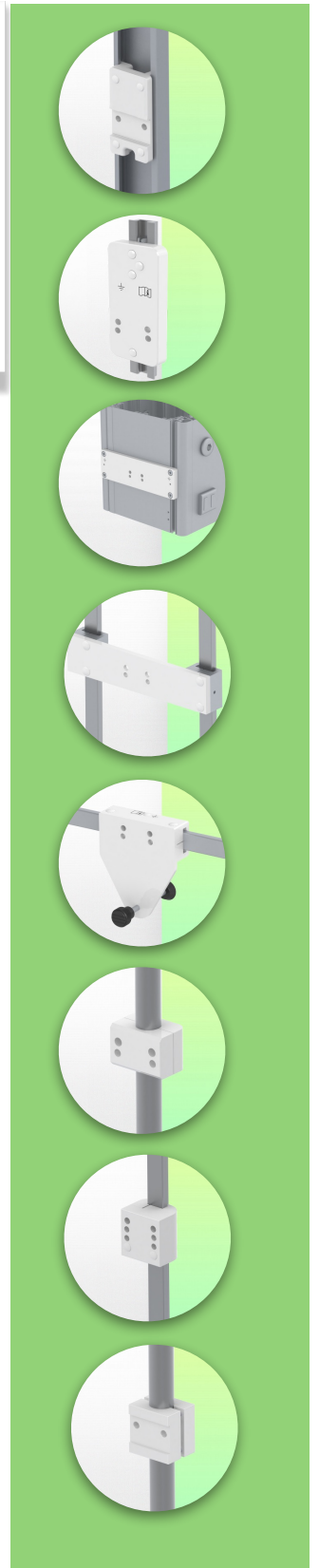
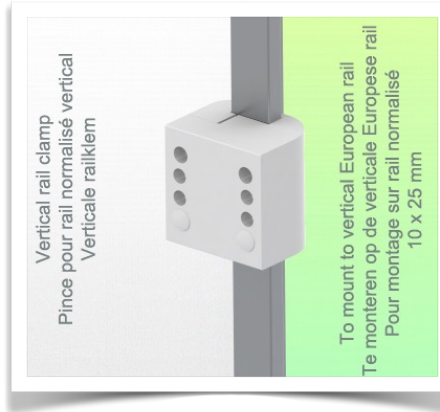
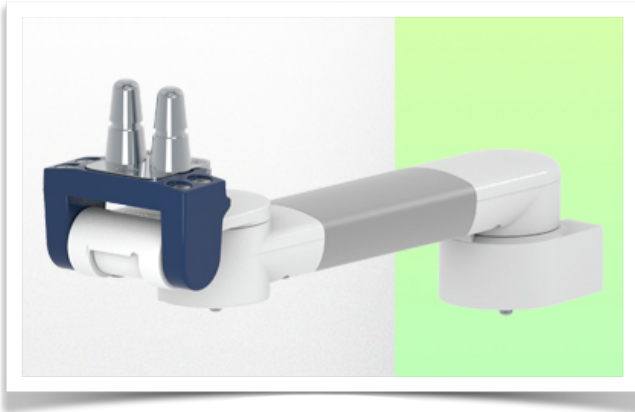

**363 mm Horizontal Medical Arm for monitoring Philips Intellivue Séries, Din rail mount Vertical.**

This 363 mm Horizontal Arm allows the monitor to be fixed, oriented and adjusted perfectly. It is coated with an anti-microbial agent to ensure hygiene and cleanliness down to the smallest detail. Its modern design has been specially developed for healthcare environments.

**Technical specifications:**

- \* Din Vertical Rail mounting Universal clamp included ( 10 x 25 mm, 8 x 35 mm, 10 x 30 mm, 10 x 50 mm )
  - \* This medical arm simply attaches to the Din Vertical Rail and then adjusts to the rail and clamps with the two grips. There is no height adjustment.
  - \* The head of this arm complies with the mounting standard for Philips Intellivue series monitors weighing up to 18 kg.
  - \* Monitor tilt: 20° down and 12° up
  - \* Monitor rotation: 115° right, 115° left.
  - \* Arm rotation: 105° right, 105° left.
  - \* Total length: 363 mm
- Colour: RAL 5013 cobalt blue and RAL 9016 traffic white
- \* Warranty: 5 years

## Technical specifications

Part Number: WM 260.112

**363 mm Horizontal Medical Arm for monitoring Philips Intellivue Séries,  
Din rail mount Vertical.**

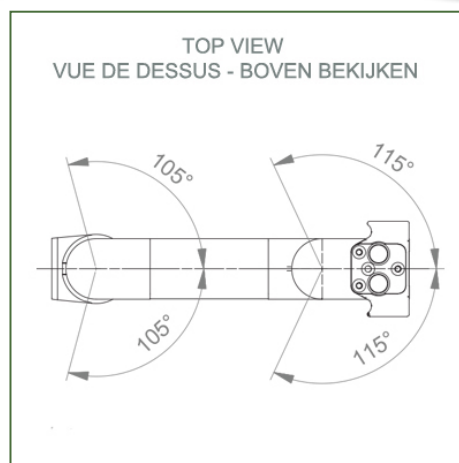
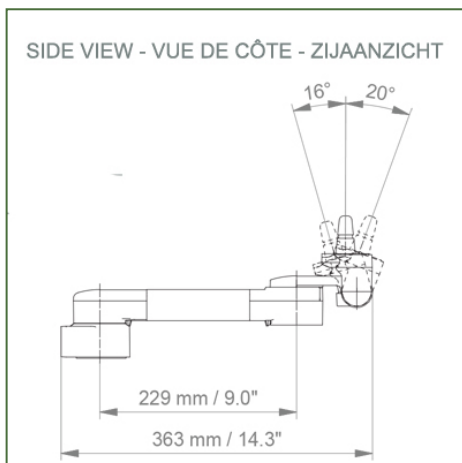
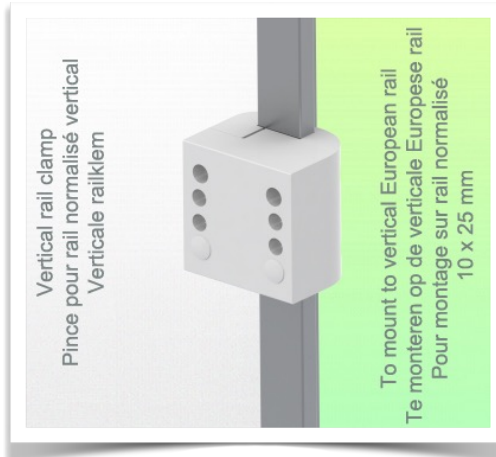
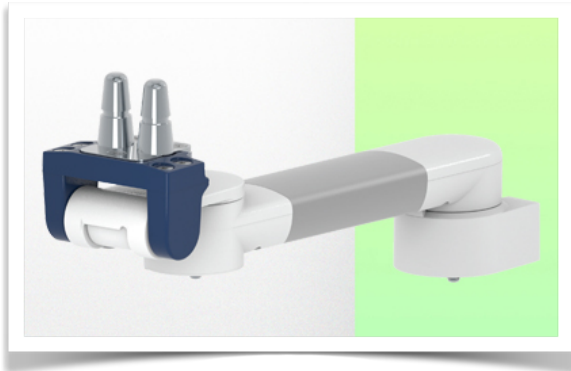

**Monitor fitting:** Philips Intellivue Series  
**Colour:** Decorative parts: RAL 5013 cobalt blue  
 Aluminium parts: RAL 9016 traffic white  
**Max. load capacity of support arm:** 18 kg  
**Monitor fitting max. load:** 18 Kg  
**Product weight:** 1,9 Kg

### Product strengths:

Non-height-adjustable arm. Swivel arms and extended swivel arms offer full cable integration and easy cleaning for infection control in all critical care areas of the clinical environment. Our 5-year guarantee ensures reliable, trouble-free and maintenance-free operation. The swivel function at the point of attachment and the tilt and swivel function of the monitor adaptation provide optimum positioning of your unit. The extended swivel arm is a two-part arm with a central pivot point between the two arm sections. All bottom-mounted monitors have the safety feature of a 20° tilt stop.

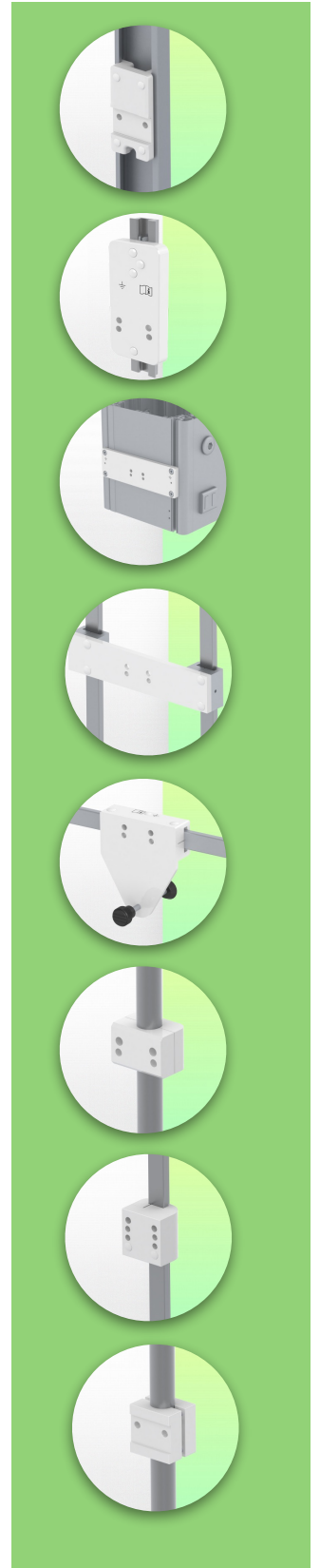

Installation information - Din Rail Vertical standard

Part Number: WM 260.112

363 mm Horizontal Medical Arm for monitoring Philips Intellivue Séries,  
Din rail mount Vertical.

**Din Vertical Rail:**

Fixed clamp for standard rail For mounting on a vertical standard rail 10 x 25 mm

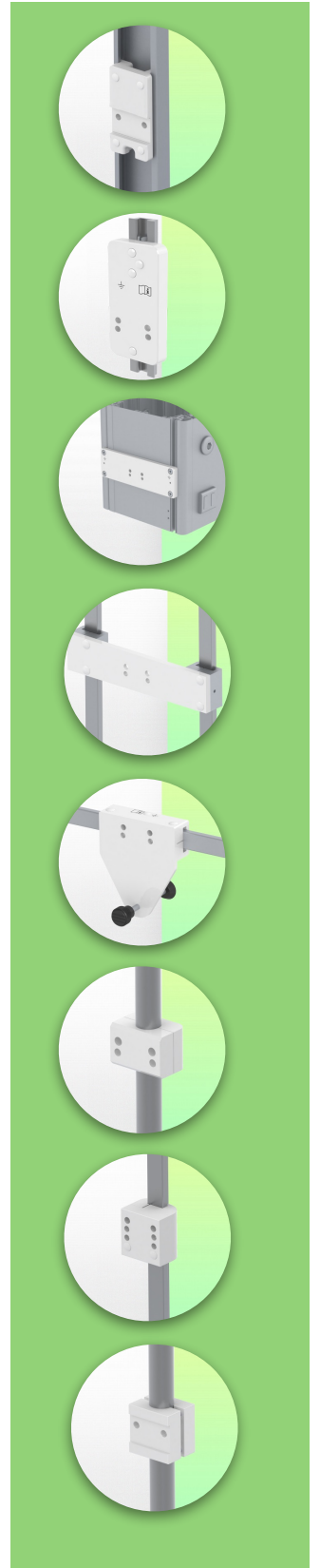
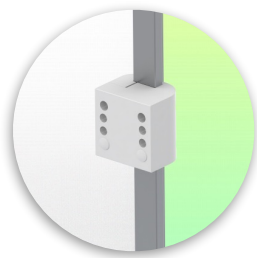
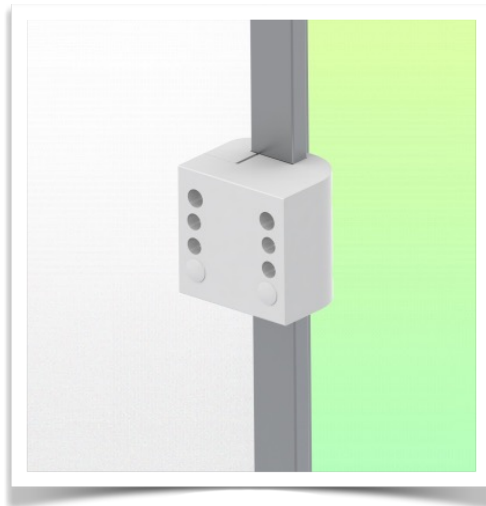
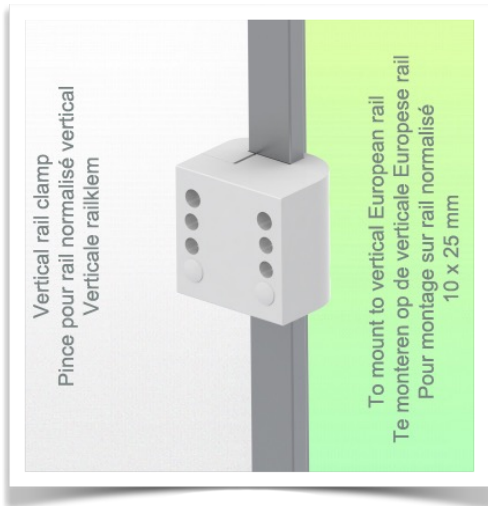

Presentation

Part Number: WM 260.112

363 mm Horizontal Medical Arm for monitoring Philips Intellivue Séries,  
Din rail mount Vertical.

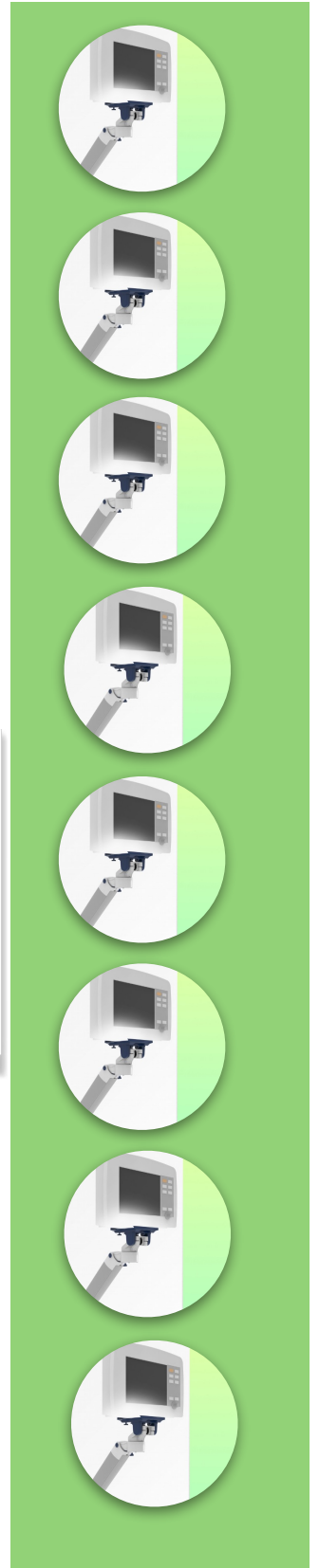
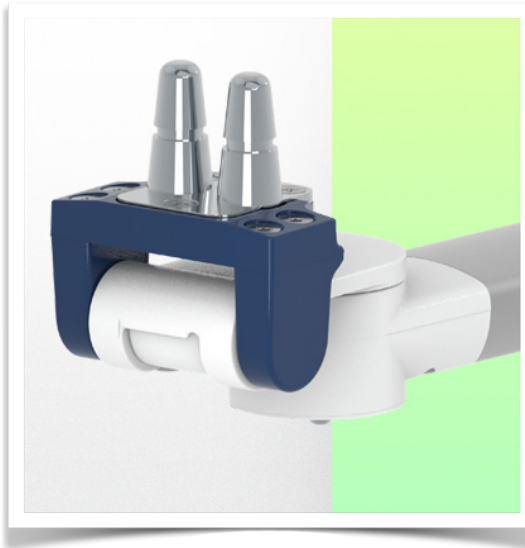
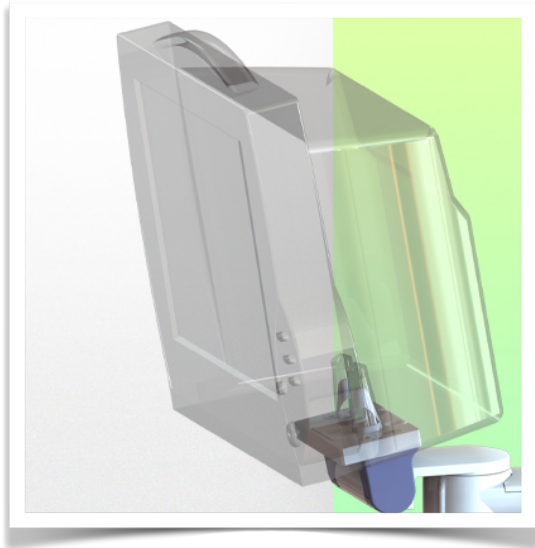

**Adaptation monitoring Philips Intellivue series**

All our medical arms can be fitted with this adaptation, some illustrations of which can be found here.

